



**THOMSON-CSF**

GROUPEMENT TUBES ELECTRONIQUES

DATA TEV 3090

**TH 9801**

July 1971 - Page 1/8

## TH 9801 1" VIDICON

- MAGNETIC FOCUS AND DEFLECTION
- HIGH RESOLUTION (850 T.V. LINES)
  - LOW LAG
- ECONOMY C. C. T. V.

TH 9801 is a 1" Vidicon used for inexpensive TV cameras. This tube incorporates in its structure the latest isolated post-acceleration electrode with separate external connection.

TH 9801 is intended for normal light level conditions: the quality of image is satisfactory for 100 lux (10 fc) scene illumination.

Satisfactory quality picture with good resolution and acceptable signal to noise ratio can be obtained at illuminations of 1 lux (100 mfc) to 2 lux (200 mfc) on the faceplate (10 to 20 lux on the subject with an unity numerical aperture lens) giving rise to a signal current of 100 nA at 50 nA dark current. For such illuminations, higher signal currents are obtained by increasing the dark current up to 100 nA, value beyond which a signal saturation will occur.

Due to a new low lag photoconductive layer an excellent picture quality can be obtained within a large range of illuminations with good signal uniformity and appropriate "gamma" characteristics.

The tube sensitivity can be controlled by the target voltage which also causes some variation of the dark current.

TH 9801 can be operated over a wide range of electrode voltage selection although the recommended adjustment requires a g4 voltage to g3 voltage ratio of 1.4 - 1.5. Under these conditions TH 9801 can provide an optimum resolution and a uniform signal output over the entire scanned area with a low geometrical distortion.

The limiting resolution of the TH 9801 is about 950 T.V. lines at center of picture and 550 T.V. lines at corner. This high resolution is obtained with 900V on electrode g4 and 600V on g3. When the TH 9801 is operated at a lower g4 voltage of 500V and g3 voltage of 300V, its limiting resolution will be 850 T.V. lines at center and 450 T.V. lines at corner. Operating g4 voltage at 1.5 times g3 voltage requires 20% deflection current increase over the current necessary for "g3 - g4 connected" mode. Focusing field is not noticeably changed with such an operation.

Full advantage of resolution and signal uniformity is achieved when the deflecting and focusing components are properly designed and when the tube is correctly located inside. The thickness of the photoconductive layer is made very uniform and allows for a constant output signal and a constant dark current. When the landing error due to an imperfect scanning system is present, the voltage gradient across the photoconductive layer is not uniform and a signal variation (shading) is introduced which can be compensated by proper adjustment of the cathode, g1 and g2 voltages.

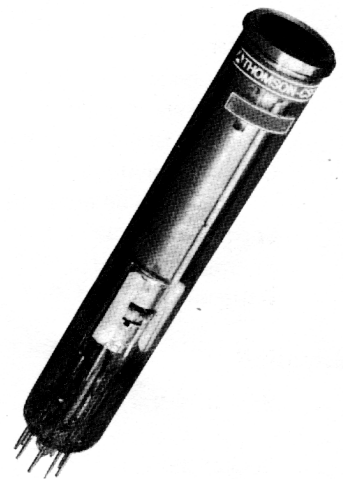



Due to good design, high reliability is obtained throughout the tube life. The necessary alignment field is reduced to a minimum by precise electron gun mounting. An extremely flat faceplate avoids all optical distortions and permits the use of any good quality lens. Particle barriers adjacent to the field mesh allow these tubes to operate in any position.

One watt power heater makes these Vidicons particularly suitable for transistorized equipment. The reduced heat dissipation improves the quality of the picture by lowering faceplate temperature.

**GENERAL CHARACTERISTICS**

**Electrical**

|  |   |
|--|---|
| Heater . . . . .                           | for unipotential cathode<br>indirectly heated |
| Heater :                                   |   |
| - Voltage . . . . .                        | 6.3 ± 10% V                                   |
| - Current at 6.3V . . . . .                | 0.15 A  |
| Minimum preheating time . . . . .          | 60 s  |
| Output capacitances :                      |   |
| - Target to all other electrodes . . . . . | 4.5 pF  |
| Spectral response . . . . .                | see curve                                     |
| Focusing method . . . . .                  | magnetic                                      |
| Deflection method . . . . .                | magnetic                                      |

**Mechanical**

|   |  |
|---|--|
| Base (Ditetrar, 8 pins) . . . . .   | UTE 9C15<br>(JEDEC N° E8 - 11)<br>METOX N° 30.250<br>GERHARD BV 200 - 1k1<br>see drawing |
| Socket (note 1) . . . . .   |  |
| Deflecting yoke (note 2) . . . . .  |  |
| Dimensions . . . . .  |  |
| Photoconductive layer :   |  |
| - Normal dimensions of image on target . . . . .  | 12.7 x 9.5 mm  |
| - Maximum useful diagonal diameter (4 x 3 aspect ratio) . . . . .                                   | 17 mm  |
| Orientation of quality rectangle :  |  |
| Horizontal scan parallel to the plane passing through the tube axis<br>and short index pin (note 3) |  |
| Maximum temperature of faceplate . . . . .  | 70 °C  |
| Mounting position . . . . .   | any  |
| Net weight, approximate . . . . .   | 60 g   |

**OPERATING CONDITIONS**

Scanned area 12.7 x 9.5 mm

**Maximum ratings**

|   |                  |           |
|---|------------------|-----------|
| E lectrode g4 voltage (post-acceleration electrode) . . . . . | 1000             | V         |
| Electrode g3 voltage (wall electrode) . . . . .               | 1000             | V         |
| Electrode g2 voltage (accelerator) . . . . .                  | 350              | V         |
| Electrode g1 voltage (electrode for picture cut-off)          |                  |           |
| - Negative bias value . . . . .                               | 300              | V         |
| - Positive bias value . . . . .                               | 0                | V         |
| Target voltage . . . . .                                      | 125              | V         |
| Dark current . . . . .  | 0.20             | µA        |
| Peak target current (note 4) . . . . .                        | 0.60             | µA        |
| Faceplate :   |                  |           |
| - Illumination . . . . .                                      | 10000<br>or 1000 | lux<br>fc |
| - Temperature . . . . .                                       | 70               | °C        |



**Typical operation**

Scanned area 12.7 x 9.5 mm  
Faceplate temperature 25 °C (note 5)

| Electrode voltage modes :   | Low         | Intermediate | High        |          |
|---|-------------|--------------|-------------|----------|
| Electrode g4 voltage . . . . .  | 300.        | 500          | 900         | V        |
| Electrode g3 voltage . . . . .  | 180         | 300 to 350   | 600         | V        |
| Electrode g2 voltage . . . . .  | 300         | 300          | 300         | V        |
| Electrode g1 (note 6) . . . . .   | -45 to -110 | -45 to -110  | -45 to -110 | V        |
| Average "gamma" for a target illumination<br>between 1 and 100 lux (note 7) . . . . .         | 0.65        | 0.65         | 0.65        |          |
| Minimum blanking peak to peak voltage :   |             |              |             |          |
| - Applied to electrode g1 . . . . .   | -75         | -75          | -75         | V        |
| - Applied to cathode . . . . .  | +20         | +20          | +20         | V        |
| Limiting resolution at center of picture (note 8)   | 750         | 850          | 950         | TV lines |
| Limiting resolution at corner of picture. . . . .   | 350         | 450          | 550         | TV lines |
| M.T.F. response at 400 T.V. lines at center of<br>picture (5 MHz - 625 CCIR standard)(note 9) | 25          | 35           | 45          | %        |
| Field at center of focusing coil . . . . .  | 30 ± 2      | 40 ± 2       | 50 ± 2      | Gauss    |
| Peak deflecting coil current :  |             |              |             |          |
| - Horizontal . . . . .  | 130         | 170          | 200         | mA       |
| - Vertical . . . . .  | 15          | 20           | 24          | mA       |
| Field of alignment coil . . . . .   | 0 to 4      | 0 to 4       | 0 to 4      | Gauss    |

**1 - HIGH LIGHT LEVEL OPERATION**

(faceplate illumination 100 lux or 10 fc)

|  |          |     |
|--|----------|-----|
| Dark current $i_o$ . . . . .                         | 5        | nA  |
| Target voltage for $i_o = 5$ nA (note 10) . . . . .  | 10 to 25 | V   |
| Faceplate illumination (2854 °K) (note 11) . . . . . | 100      | lux |
|  | or 10    | fc  |
| Signal current . . . . .                             | 250      | nA  |
| Lag : (note 12)                                      |          |     |
| - Maximum . . . . .                                  | 15       | %   |
| - Average . . . . .                                  | 10       | %   |

**2 - AVERAGE SENSITIVITY OPERATION**

(faceplate illumination 10 lux or 1 fc)

|   |          |            |
|---|----------|------------|
| Dark current $i_o$ . . . . .                            | 20       | nA         |
| Target voltage for $i_o = 20$ nA (note 10) . . . . .    | 15 to 50 | V          |
| Faceplate illumination (2854 °K) (note 11) . . . . .    | 10       | lux        |
|   | or 1     | fc         |
| Signal current . . . . .                                | 150      | nA         |
| Corresponding sensitivity . . . . .                     | 125      | $\mu A/lm$ |
| Target illumination for 100 nA signal current . . . . . | 5        | lux        |
|   | or 500   | mfc        |
| Lag : (note 12)   |          |            |
| - Maximum . . . . .                                     | 20       | %          |
| - Average . . . . .                                     | 12       | %          |



**3 - HIGH SENSITIVITY OPERATION**

(faceplate illumination 5 lux or 500 mfc)

|   |              |            |
|---|--------------|------------|
| Dark current $i_0$ . . . . .                            | 50           | nA         |
| Target voltage for $i_0 = 50$ nA (note 10) . . . . .    | 20 to 60     | V          |
| Faceplate illumination (2854 °K) (note 11) . . . . .    | 5 lux or 500 | mfc        |
| Signal current . . . . .                                | 180          | nA         |
| Corresponding sensitivity . . . . .                     | 300          | $\mu A/lm$ |
| Target illumination for 100 nA signal current . . . . . | 2            | lux        |
|   | or 200       | mfc        |
| Lag : (note 12)   |              |            |
| - Maximum . . . . .                                     | 20           | %          |
| - Average . . . . .                                     | 15           | %          |

**4 - SPURIOUS SIGNAL TEST**

The test is performed using a uniformly diffused white test pattern that is separated into two zones as shown in drawing

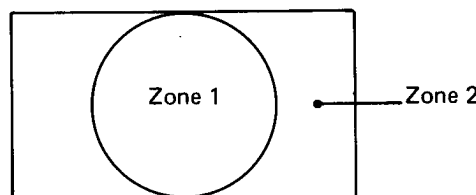

The tube is operated under the "Typical Operation" conditions with a dark current of 20 nanoamperes and the lens adjusted to provide a signal current of 200 nanoamperes.

Spurious signals are classified by their size, which is measured in percent of raster height.

Will actually be considered as defects, blemishes of contrast greater than 50% (note 13).

Allowable spot size for each zone is shown in table :

| Ratio D/H *<br>(Percent raster height) | Number Allowed |                 |       |           |
|--|----------------|-----------------|-------|-----------|
|  | Zone 1         | Zone 1 + Zone 2 |       |           |
|  |                | a               | a + b | a + b + c |
| a : $0.8\% < D/H \leq 1\%$             | 2              | 3               | 7     | 12        |
| b : $0.6\% < D/H \leq 0.8\%$           | 3              |                 |       |           |
| c : $0.2\% < D/H \leq 0.6\%$           | 4              |                 |       |           |

0.2 % and under : do not count spots of this size unless concentration causes a smudge appearance.

\* D : average diameter of spot  
H : raster height

Smudges, streaks, mottled or grainy background having a contrast ratio greater than 15 % constitute a reject.



## NOTES

- 1 - METOX - 86, rue de Villiers de l'isle Adam - PARIS 20ème  
Téléphone : 636 31 10
- 2 - GERHARD KG - REICHELSEIM / ODW Germany
- 3 - It is necessary to assure correct positioning of the tube inside the coils. An immediate test consists in observing the fine mesh grid, the wires of which should be inclined  $45^\circ$  with respect to scanning. Then again the front end of the deflecting yoke should be positioned at 20 mm from the tube faceplate.
- 4 - Target current is defined as total current in load resistance connected to target electrode: signal current plus dark current, dark current being the current left when illumination is subtracted.  
Video amplifiers must be designed properly to handle peak target current of  $0.7 \mu\text{A}$  to avoid amplifier overload and picture distortion.
- 5 - All these characteristics are provided for a temperature of faceplate of  $25^\circ\text{C}$ , the temperature range recommended is within 20 to  $30^\circ\text{C}$ . The rise of faceplate temperature is a function of ambient temperature, thermic dissipation of ambient devices and of the tube itself. Consequently,  $10^\circ\text{C}$  of faceplate temperature rise implies a dark current multiplied by a factor of 2.
- 6 - Without blanking pulses applied on electrode g1.
- 7 - Average "gamma" should be defined as the slope of the rectilinear part of transfer characteristics in log coordinates.
- 8 - Practically, limiting resolution corresponds to the resolution measured with twin bar test card with a modulation ratio of about 7 %.
- 9 - For 625 lines C.C.I.R. standard, line duration being  $52 \mu\text{s}$  (line suppression period not included), 400 TV lines correspond to 5 MHz.
- 10 - Indicated range of each type of service serves only to illustrate the operating target voltage range normally encountered. The target voltage for each Vidicon must be adjusted to that value which gives the designed operating dark current.
- 11 - All the above mentioned illumination assume  $2854^\circ\text{K}$  incandescent tungsten source.
- 12 - Lag is defined as the ratio of residual signal current measured 60 milliseconds after light excitation being removed to the initial signal current : this value assumes 50 field/second scanning rate.
- 13 - Contrast is defined as :  $100 \times \frac{\text{increment in video current due to the blemish}}{\text{normal signal current}}$



Figure 1

TYPICAL SPECTRAL SENSITIVITY CHARACTERISTICS

For equal values of signal current at all wavelengths  
(0.02  $\mu$ A signal current and 0.02  $\mu$ A dark current  
for scanned area of 12.7 x 9.5 mm)

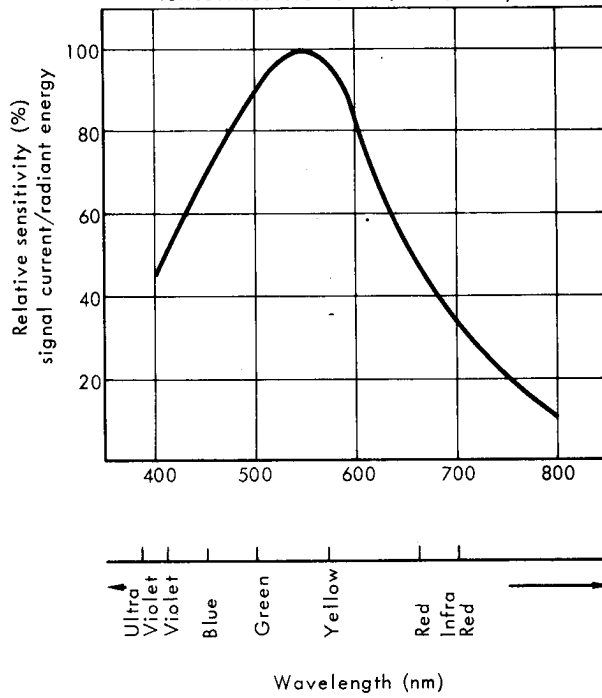

Figure 2

LIGHT TRANSFER CHARACTERISTICS

Illumination uniform over photoconductive layer scanned  
area 12.7 x 9.5 mm-face plate temperature 25°C

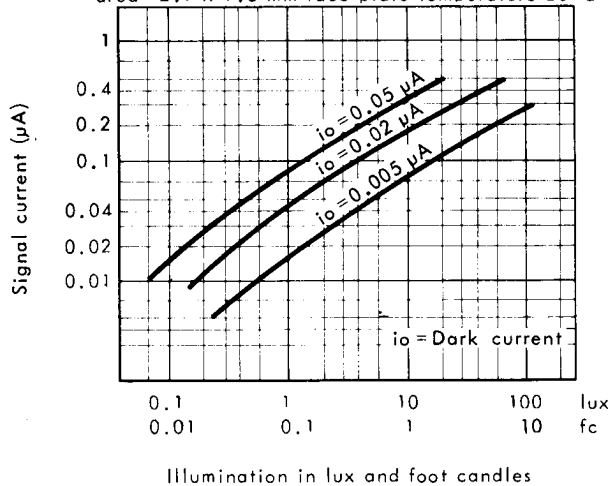



Figure 3

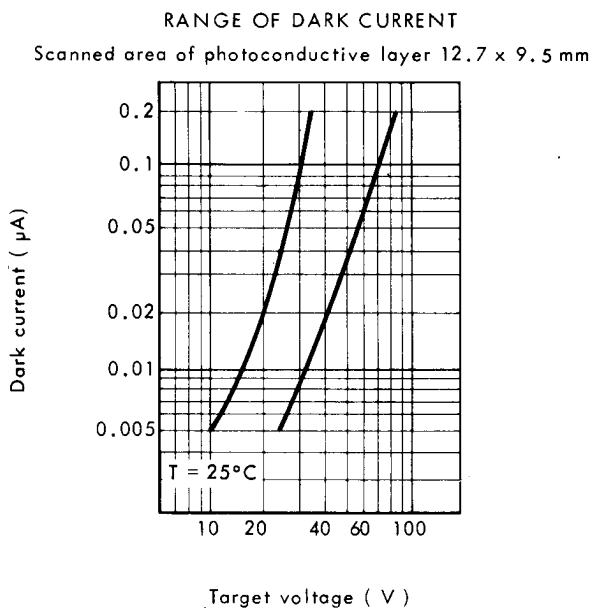

Figure 4

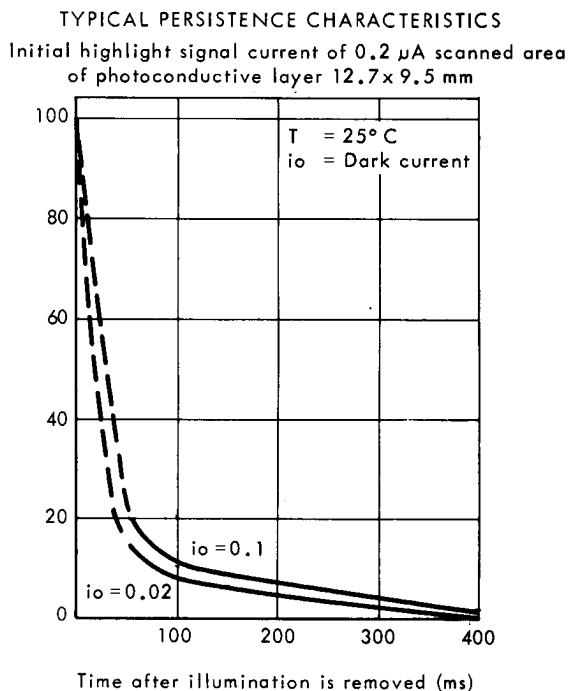
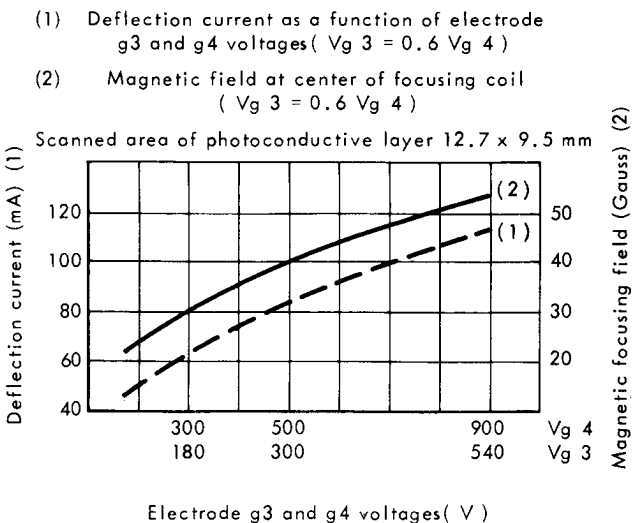

Figure 5





**OUTLINE DRAWING**

UTE 9C15 base  
(JEDEC E8-11)

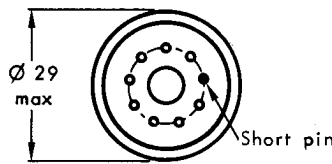

BASING DIAGRAM

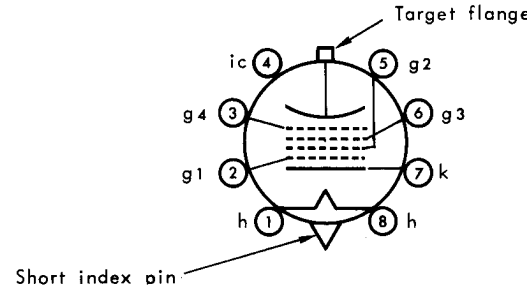

|                         |                  |
|-------------------------|------------------|
| 1 - Heater              | 5 - Electrode g2 |
| 2 - Electrode g1        | 6 - Electrode g3 |
| 3 - Electrode g4        | 7 - Cathode      |
| 4 - Internal connection | 8 - Heater       |

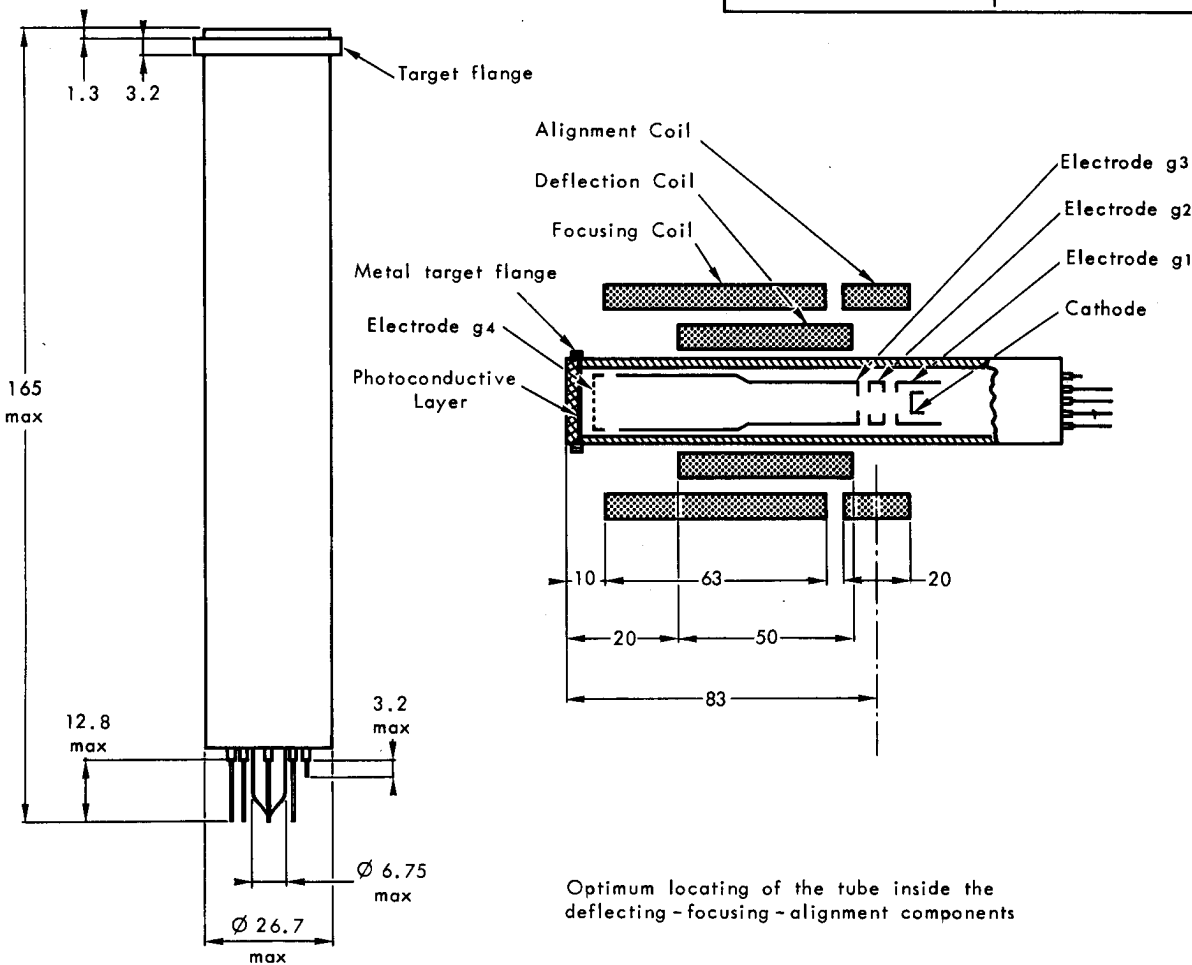

Optimum locating of the tube inside the deflecting - focusing - alignment components

Dimensions in mm.

