



Velocity Modulated Oscillator

Code: V233A/1K (CV2190)

This is a velocity-modulated oscillator of the coaxial-line type for CW operation in the frequency range 2700 to 4200 Mc/s.

CATHODE.

Indirectly-heated, oxide-coated

Heater voltage	6.3	V
Nominal current	0.3	A
(A.C. frequencies above 1.5 kc/s must not be used)		

DIMENSIONS.

Maximum overall length	73	mm
Maximum bulb diameter	20.1	mm
Base	B7G	
Net weight	21	g

MOUNTING.

The valve is designed to mount by means of the resonator disc so that the antenna couples into a suitable tuning circuit.

MAXIMUM RATINGS.

The mean input power to all electrodes,
other than the heater

	18	W
Maximum direct cathode current	65	mA
Maximum direct screen voltage	400	V
Maximum screen dissipation	1.5	W

Velocity Modulated Oscillator



Code: V233A/1K (CV2190)

TYPICAL OPERATING CONDITIONS.

Oscillator in the frequency range 2700 to 4200 Mc/s.

Grid voltage (V_{g1})

40 volts negative with respect to cathode. The use of bias improves the proportion of cathode current which passes through the resonator and reaches the anode. See Figure 6 for a sketch of the electrode assembly.

Resonator voltage (V_{res})

At 3300 Mc/s, 250 V \pm 5%. For other frequencies the resonator voltage is approximately proportional to the square of the frequency. See Figure 1.

Screen voltage (V_{g2})

Zero to $V_{res} + 50$ volts. Adjusted to give an anode dissipation of 10 watts, provided that the cathode current does not exceed 65 mA.

Screen current (I_{g2})

Not greater than 5 mA.

Anode voltage (V_a)

10 to 20 volts positive with respect to resonator.

Output power (P_o)

Not less than 300 mW over the frequency range 2700 to 4200 Mc/s when operated in the tuning circuit of Figure 7, and when the load is adjusted for maximum power output. In Figure 3 power output is plotted as a function of frequency for several values of anode dissipation.



Velocity Modulated Oscillator

Code: V233A/1K (CV2190)

CIRCUIT.

Figure 7 shows a sketch of a suitable tuning circuit. The frequency of oscillation is a function of circuit length L , i.e. piston position, and the frequency range is determined by the stroke of the piston. Curves of circuit length as a function of frequency are plotted in Figure 2. The valve will operate satisfactorily in other types of circuit, with certain differences in performance. Further information may be obtained on application to the Chief Valve Engineer, Standard Telephones and Cables Limited, Dowlish Ford Mills, Ilminster, Somerset.

OUTPUT COUPLING.

The specified output power is obtainable over the entire range 2700 to 4200 Mc/s by means of a coupling loop placed either at the piston face (position A of Figure 7), or at the valve end of the circuit (position B).

Using Position A, satisfactory loading of the valve into 70 ohm coaxial cable is obtainable for a fixed loop position (pre-set at midband) over a limited range, e.g. 3600 to 4200 Mc/s. In Position B, however, it is usually necessary to make an adjustment of the loop orientation when tuning the oscillator over the frequency range. For applications where such adjustments of the loops are inadmissible the impedance at the loop must be transformed to that of the load by means of an appropriate impedance matching technique.

UNLOADED STARTING CURRENT.

The anode current at which oscillations just start, when the valve is loaded only by the circuit, is referred to as the "unloaded starting current", and serves as a useful measure of the efficiency of the tuning circuit. In Figure 4 the unloaded starting current for a typical valve is plotted as a function of frequency using the recommended circuit.

To illustrate the importance of good tuning circuit construction a curve of power output versus the unloaded starting current of the valve circuit combination is given in Figure 5.

Velocity Modulated Oscillator



Code: V233A/1K (CV2190)

OUTPUT MODULATION.

(a) Amplitude modulation.

The voltage required is dependent both upon the particular operating conditions, and the loading of the valve. For 100 per cent modulation it is only necessary to reduce the anode current to a value below the starting current of oscillation.

Modulation of either the grid (g_1) or the screen (g_2) is permissible. Modulating voltages of between -50 and -200 applied to the grid will be found to be adequate. For the screen, however, positive modulating voltages of the same order are necessary, and, since the screen takes current, adequate modulation power should be provided.

(b) Frequency modulation.

Although the valve is not specifically designed for frequency modulation about ± 1 Mc/s is available by variation of the resonator voltage.

MAGNET AND MAGNET ALIGNMENT.

The recommended magnet is Jessop Type No. 10512, but any magnet giving a uniform field of approximately 1200 oersteds over a 22 mm gap can be used. The magnet must be aligned so that the best ratio of anode current to cathode current is obtained (see Figure 6). Three holes are punched in the valve disc and locate on pins fixed to the valve clamping plate. Once the magnet has been aligned, and has been securely clamped with respect to the locating pins, no further adjustment will be necessary when replacing valves. It is recommended that at least three, and preferably six, valves are used to establish the initial alignment of the magnet.



Velocity Modulated Oscillator

Code: V233A/1K (CV2190)

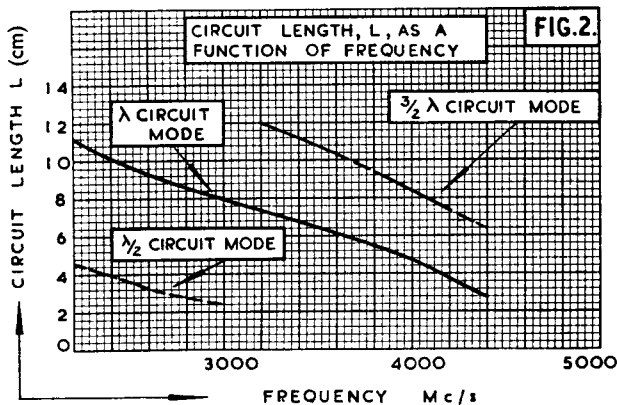
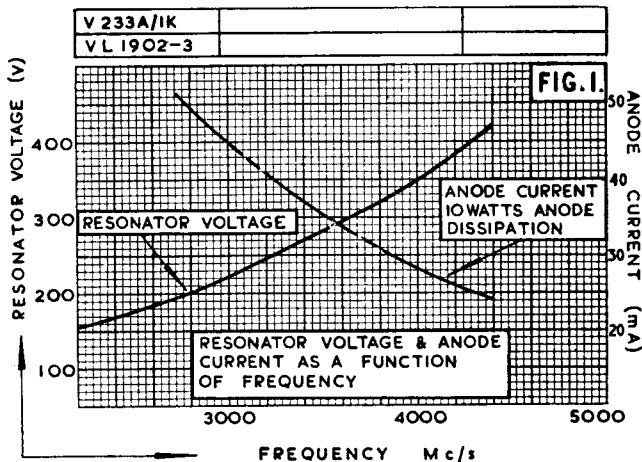

Velocity Modulated Oscillator



Code: V233A/1K (CV2190)

V 233A/1K		
VL 1903		

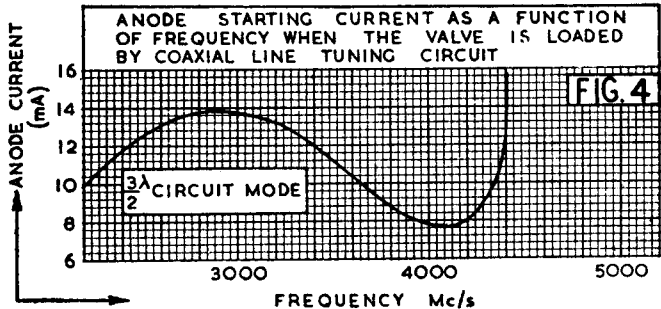
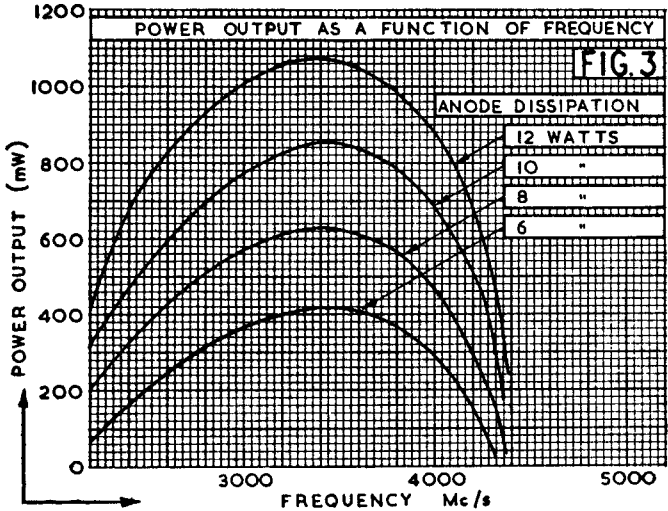



Velocity Modulated Oscillator

Code: V233A/1K (CV2190)

V235A/1K		$f = 3800 \text{ Mc/s}$
VL 2524		$I_a = 30 \text{ mA}$

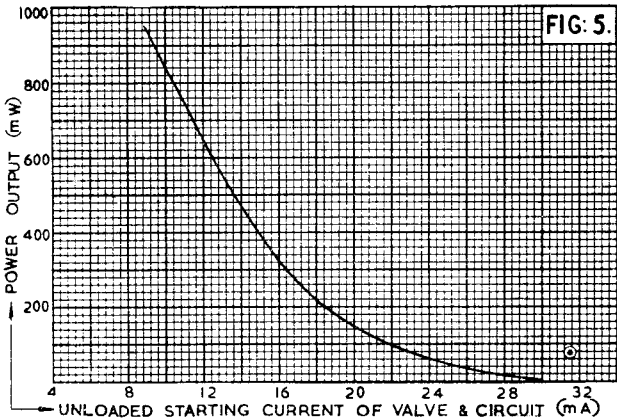

Velocity Modulated Oscillator



Code: V233A/1K (CV2190)

FIG. 6

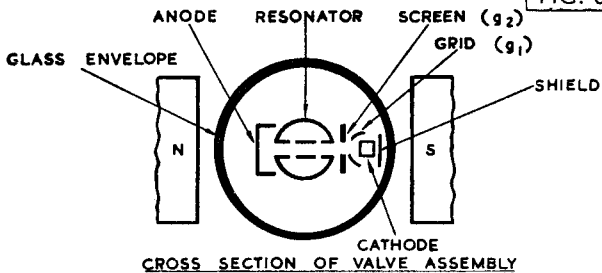

CROSS SECTION OF VALVE ASSEMBLY

FIG. 7

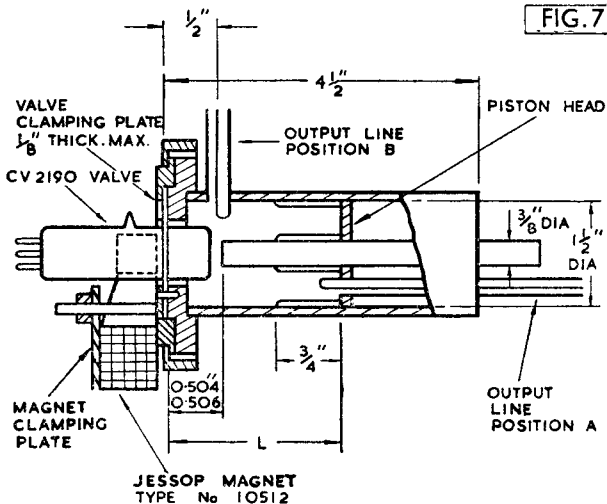



Velocity Modulated Oscillator

Code: V233A/1K (CV2190)

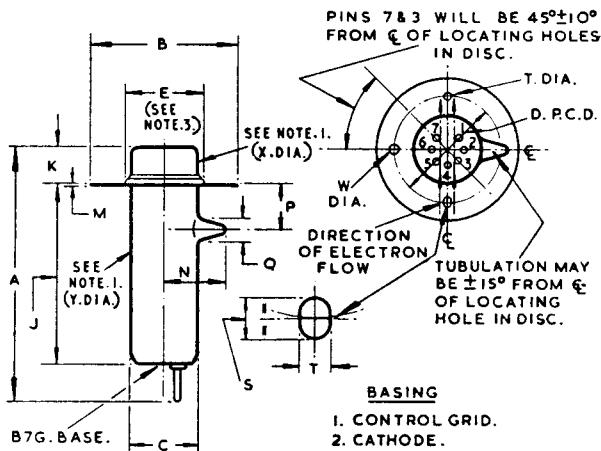

NOTE. 1. THIS PORTION OF BULB
WILL NOT FOUL A
CYLINDER OF INT. DIA. SPECIFIED
WHICH IS CONCENTRIC WITH THE PITCH
CIRCLE OF THE LOCATING HOLES IN
THE DISC.

DIM	MILLIMETRES	INCHES	DIM	MILLIMETRES	INCHES
A	73 MAX.	$2\frac{7}{8}$ MAX.	P	13.5 ± 4.0	0.53 ± 0.16
B	42 MAX.	1.65 MAX.	Q	8.5 MAX.	0.33 MAX.
C	20.1 MAX.	0.79 MAX.	S	$3.2 + 0.13$ $- 0.00$	$0.125 + 0.005$ $- 0.000$
D	30.96 ± 0.06	1.218 ± 0.002	T	$2.36 + 0.06$ $- 0.00$	$0.093 + 0.002$ $- 0.000$
E	24 MAX.	0.94 MAX.	W	$2.79 + 0.13$ $- 0.00$	$0.110 + 0.005$ $- 0.000$
J	46.0 ± 6.4	$1\frac{13}{16} \pm \frac{1}{4}$	N	18 MAX.	0.710 MAX.
K	11.1 MIN. 12.5 MAX.	0.437 MIN. 0.504 MAX.	X	21.59 MIN.	0.850 MIN.
M	0.3 MAX.	0.012 MAX.	Y	20.32 MIN.	0.800 MIN.

NOTE.2-BASIC FIGURES ARE INCHES.
NOTE.3-ALSO MIN. CLAMPING DIA.