

## Image Intensifier Tubes

Fiber-Optic Input and Output Faceplates

Integrated Voltage Multiplier Incorporated in 8606

Ruggedized Construction

S-20 Spectral Response with Extended Red Sensitivity

P20 Phosphor Screen

## GENERAL

## Each Type

|  |   |
|--|---|
| Spectral Response . . . . .              | S-20 with extended red response   |
| Wavelength of Maximum Response . . . . . | 4700 $\begin{matrix} +1000 \text{ \AA} \\ - 500 \text{ \AA} \end{matrix}$ |
| Photocathode:                            |   |
| Material . . . . .                       | Na-K-Cs-Sb (Multialkali)  |
| Minimum useful area                      |   |
| <b>Type 8606</b> . . . . .               | 11.1 cm <sup>2</sup> (1.70 in <sup>2</sup> )                              |
| <b>Types 8605/V1, 8605/V2</b> . . . . .  | 12.6 cm <sup>2</sup> (1.96 in <sup>2</sup> )                              |
| Minimum useful diameter                  |   |
| <b>Type 8606</b> . . . . .               | 37.5 mm (1.47 in)   |
| <b>Types 8605/V1, 8605/V2</b> . . . . .  | 40 mm (1.58 in)   |
| Image surface:                           |   |
| Shape . . . . .                          | Flat, Circular  |
| Material . . . . .                       | Fiber-Optics  |
| Fluorescent Screen:                      |   |
| Minimum useful area . . . . .            | 13.8 cm <sup>2</sup> (2.14 in <sup>2</sup> )                              |
| Minimum useful diameter . . . . .        | 42 mm (1.65 in)   |
| Phosphor . . . . .                       | P20, Aluminized   |
| Fluorescence and phosphorescence         | Yellow-Green  |
| Persistence . . . . .                    | Medium to Medium Short  |
| Image surface:                           |   |
| Shape . . . . .                          | Flat, Circular  |
| Material . . . . .                       | Fiber-Optics  |
| Focusing Method . . . . .                | Electrostatic   |

\***Note:** The 8605/V1 is equivalent to the image intensifier designated 8605-1 by the military and the 8605/V2 is equivalent to the image intensifiers designated 8605-2 and 8605-3.

# 8605/V1, 8605V2, 8606

## Tube Dimensions:

Maximum overall length

|                                  |                       |
|----------------------------------|-----------------------|
| Type 8606 . . . . .              | 12.028 in (302.51 mm) |
| Types 8605/V1, 8605/V2 . . . . . | 3.705 in (94.2 mm)    |

Maximum diameter

|                                  |                     |
|----------------------------------|---------------------|
| Type 8606 . . . . .              | 3.737 in (95.10 mm) |
| Types 8605/V1, 8605/V2 . . . . . | 3.05* in (77.5 mm)  |

Operating Position . . . . . Any

Weight (Approx.)

|                                  |                      |
|----------------------------------|----------------------|
| Type 8606. . . . .               | 4 lbs 8 oz (2.04 kg) |
| Types 8605/V1, 8605/V2 . . . . . | 14 oz (0.396 kg)     |

## MAXIMUM RATINGS, *Absolute-Maximum Values*

Peak-to-Peak AC Input Voltage<sup>b</sup>

|                     |                         |
|---------------------|-------------------------|
| Type 8606 . . . . . | 2.8 kV, 1200 to 2000 Hz |
|---------------------|-------------------------|

DC Anode-to-Cathode Voltage

|                                  |       |
|----------------------------------|-------|
| Types 8605/V1, 8605/V2 . . . . . | 16 kV |
|----------------------------------|-------|

Screen Luminance (Brightness)

|                                  |        |
|----------------------------------|--------|
| Types 8605/V1, 8605/V2 . . . . . | 125 fL |
|----------------------------------|--------|

### Each Type

Ambient-Temperature Range:

|                         |                |
|-------------------------|----------------|
| Non-operating . . . . . | -54° to +68° C |
| Operating . . . . .     | -54° to +52° C |

## ELECTRICAL CHARACTERISTICS, Type 8606 Only

|                                       | Min. | Typical | Max. |
|---------------------------------------|------|---------|------|
| Input Capacity <sup>c</sup> . . . . . | 22   | —       | 55   |

\*Excluding exhaust tubulation cap.

## TYPICAL PERFORMANCE CHARACTERISTICS

| Characteristic                                     | Type 8606<br>Under conditions with 2.7<br>± .05 kV 1500 Hz applied<br>and at an ambient temper-<br>ature of 22° C, unless<br>otherwise noted. |         | Type 8605/V1<br>Under conditions with a DC<br>anode voltage of 15 kV and<br>at an ambient temperature<br>of 22° C, unless otherwise<br>noted. |                 | Type 8605/V2<br>Under conditions with a DC<br>anode voltage of 15 kV and<br>at an ambient temperature<br>of 22° C, unless otherwise<br>noted. |                   |
|--|---|---------|---|-----------------|---|-------------------|
|  | Min.  | Typical | Max.  | Min.            | Typical   | Max.              |
| Resolution:<br>Center <sup>d</sup> . . . . .       | 25  | 35      | —   | 57              | 70  | —                 |
| Edge <sup>e</sup><br>(Peripheral) . . . . .        | 23  | 30      | —   | 45              | —   | —                 |
| Screen Luminance<br>(Brightness) . . . . .         | —   | —       | 125 <sup>f</sup>  | —               | —   | —                 |
| Luminance Gain: <sup>9</sup><br>At 22° C . . . . . | —   | —       | —   | —               | —   | —                 |
| At 54° C . . . . .                                 | 3.5 x 10 <sup>4</sup>   | —       | —   | 65 <sup>h</sup> | —   | —                 |
| With green light<br>source . . . . .               | 2.8 x 10 <sup>4</sup>   | —       | —   | —               | —   | —                 |
|  | —   | —       | —   | —               | —   | 22 <sup>i</sup>   |
|  |   |         |   |                 |   | Line-<br>Pairs/mm |
|  |   |         |   |                 |   | Line-<br>Pairs/mm |
|  |   |         |   |                 |   | fL                |
|  |   |         |   |                 |   | fL/fc             |
|  |   |         |   |                 |   | fL/fc             |
|  |   |         |   |                 |   | fL/fc             |

## TYPICAL PERFORMANCE CHARACTERISTICS (Cont'd)

| Characteristic   | Type 8606<br>Under conditions with 2.7<br>± .05 kV 1500 Hz applied<br>and at an ambient temper-<br>ature of 22° C, unless<br>otherwise noted. | Type 8605/V1<br>Under conditions with a DC<br>anode voltage of 15 kV and<br>at an ambient temperature<br>of 22° C, unless otherwise<br>noted. | Type 8605/V2<br>Under conditions with a DC<br>anode voltage of 15 kV and<br>at an ambient temperature<br>of 22° C, unless otherwise<br>noted. |
|--|---|---|---|
| Equivalent Screen  | —   | —   | —   |
| Background Input:  | —   | —   | —   |
| Luminous <sup>k</sup> . . . . .  | 2 x 10 <sup>-11</sup>   | 2 x 10 <sup>-11</sup>   | 2 x 10 <sup>-10</sup> lm/cm <sup>2</sup>  |
| Photocathode   | —   | —   | —   |
| Sensitivity:   | —   | —   | —   |
| Radiant:   | —   | —   | —   |
| At 4700 Å <sup>m</sup> . . . . .   | 4.6 x 10 <sup>-2</sup>  | 4.6 x 10 <sup>-2</sup>  | 4.6 x 10 <sup>-2</sup> —  |
| At 8000 Å . . . . .  | 6 x 10 <sup>-3</sup>  | —   | —   |
| At 8500 Å . . . . .  | 1 x 10 <sup>-3</sup>  | —   | —   |
| Luminous <sup>n</sup> . . . . .  | 1.75 x 10 <sup>-4</sup>   | 1.75 x 10 <sup>-4</sup>   | 1.6 x 10 <sup>-4</sup> —  |
| Luminance  | —   | —   | —   |
| Uniformity . . . . .   | 3:1 <sup>p</sup>  | 1.4:1 <sup>q</sup>  | 1.4:1 <sup>r</sup> 2:1 <sup>r</sup>   |
| Modulation Transfer<br>Function (MTF): <sup>s</sup> 1<br>(S <sup>r</sup> ext page) | —   | —   | —   |

## TYPICAL PERFORMANCE CHARACTERISTICS (Cont'd)

| Characteristic  | <b>Type 8606</b><br>Under conditions with 2.7<br>$\pm .05$ kV 1500 Hz applied<br>and at an ambient temper-<br>ature of 22° C, unless<br>otherwise noted. | <b>Type 8605/V1</b><br>Under conditions with a DC<br>anode voltage of 15 kV and<br>at an ambient temperature<br>of 22° C, unless otherwise<br>noted. | <b>Type 8605/V2</b><br>Under conditions with a DC<br>anode voltage of 15 kV and<br>at an ambient temperature<br>of 22° C, unless otherwise<br>noted. |
|---|--|--|--|
| For 2.5 Line-<br>Pairs/mm . . . . .                             | 90   | -  | -  |
| For 7.5 Line-<br>Pairs/mm . . . . .                             | 55   | -  | -  |
| For 16 Line-<br>Pairs/mm . . . . .                              | 10   | -  | -  |
| Paraxial Image<br>Magnification<br>(Cmx) <sup>†</sup> . . . . . | 0.82   | 0.94   | 0.94   |
| Edge Image<br>Magnification <sup>v</sup> . . . . .              | 1.0  | -  | -  |
| Image Align-<br>ment . . . . .                                  | -  | -  | -  |
| Image Stability in<br>30 seconds <sup>w</sup> . . . . .         | -  | -  | -  |
| Distortion <sup>x</sup> . . . . .                               | -  | -  | -  |
|   |  | 0.02   | 0.02   |
|   |  | 0.005  | 0.005  |
|   |  | 8  | 8  |
|   |  | %  | in   |
|   |  | %  | in   |
|   |  | %  | %  |

# 8605/V1, 8605/V2, 8606

- b** Suitable oscillators providing this input voltage are available from the Microsemiconductor Corporation, Culver City, CA; Varo, Inc., Plano, TX 75074; or Venus Scientific Inc., 25 Bloomingdale Road, Hicksville, NY 11801.
- c** At the maximum rated peak-to-peak ac input voltage of 2.8 kV, 1200 to 2000 Hz, the maximum dc charging current will not exceed 200 microamperes. Charging current is defined as the peak value of the rectified charging current after the sinusoidal component has been subtracted. See waveshape below. Input capacity is measured at a temperature of  $+52^{\circ}\text{C}$ , with operating voltage applied, no light incident on the photocathode, and the tube shielded in a close-fitting, grounded metallic cylinder.

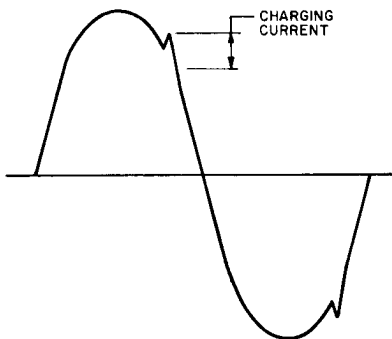

92LS-3104

- d** The resolution, both horizontal and vertical, is determined with a test pattern consisting of alternate black and white lines of equal width. Any two adjacent lines are designated a "line-pair."
- e** This minimum value applies at a distance of 11 mm from the major (optical) axis of the tube.
- f** With  $1 \times 10^{-3}$  footcandle or greater on the photocathode. The 8606 must be protected from overload by the use of a low power output oscillator when exposed to illumination levels above the specified value. Oscillators meeting the Military Specification 052374 are satisfactory. Vendors see footnote (b).

- <sup>g</sup> Luminance Gain is defined as the quotient of screen brightness in footlamberts by the photocathode illumination in footcandles provided by a tungsten-filament lamp having a lime-glass envelope. The lamp is operated at a color temperature of  $2854^{\circ}$  K. The value of light input radiation on the photocathode image surface is in the range of  $1 \times 10^{-5}$  to  $3 \times 10^{-5}$  footcandle.
- <sup>h</sup> Under same conditions of footnote (g) except input radiation on photocathode is  $5 \times 10^{-2}$  footcandle. Anode voltage is 15 kV.
- <sup>i</sup> Under the same conditions of footnote (g) except that a light input of  $5 \times 10^{-2}$  footcandle is incident on Corning C.S. No.3-71 and C.S. No.4-67 interposed between the light source and the tube. Anode voltage is 15 kV. Use of these filters in conjunction with the  $2854^{\circ}$  K source closely approximates the P20 spectral distribution.
- <sup>k</sup> Defined as the equivalent value of luminous flux from a tungsten-filament lamp operating at  $2854^{\circ}$  K that would be required to cause an increase in screen brightness equal to screen background brightness.
- <sup>m</sup> For incident radiation at the wavelength of maximum response of the spectral sensitivity characteristic.
- <sup>n</sup> Under the following conditions: The light source is a tungsten-filament lamp having a lime-glass envelope. The lamp is operated at a color temperature of  $2854^{\circ}$  K. The light spot has a minimum diameter of 1.1".
- <sup>p</sup> The light source is a tungsten-filament lamp having a lime-glass envelope. The lamp is operated at a color temperature of  $2854^{\circ}$  K. Luminance uniformity will not vary more than the ratio stated over a circular area 32.5 mm in diameter centered on the image screen. No distinct line of demarcation between light and dark areas is permitted. Alternatively, tubes will conform to MIL-I-55493 (EL) Uniformity Specification dated 26 November, 1968.
- <sup>q</sup> The light source is a tungsten-filament lamp having a lime-glass envelope. The lamp is operated at a color temperature of  $2854^{\circ}$  K. Luminance uniformity will not vary more than the ratio stated over a circular area 38 mm in diameter centered on the image screen. No distinct line of demarcation between light and dark areas is permitted.
- <sup>r</sup> Under the same conditions as shown in footnote (q) except that Corning C.S. No.3-71 and C.S. No.4-67 filters are interposed between the light source and the tube.

# 8605/V1, 8605/V2, 8606

- <sup>s</sup> A two-dimensional resolution pattern, providing constant illumination in the Y direction, and sinusoidal variation of intensity in the X direction is projected on the photocathode. Per cent image modulation M may then be defined as:

$$M = \frac{W - B}{W + B} \times 100$$

where W = maximum illumination in white line

B = minimum illumination in black line

Output image brightness is also a sinusoidal function of the distance across one direction of the pattern, and the output modulation is equal to or less than the input modulation. The modulation transfer function (MTF) is defined as the ratio of the output modulation to input modulation expressed as a function of the spatial frequency of the incident illumination pattern. MTF for type 8606 is measured using Modulation Transfer Function Analyzer Model No. K1-b, a product of Optics Technology, Inc., Belmont, CA, using the specified procedure for that instrument.

- <sup>†</sup> Paraxial Image Magnification (Cmx) is defined as the ratio of the separation of two diametrically opposite image points on the screen to the separation of the two corresponding image points on the photocathode. The image points on the photocathode are separated by a distance of 2 mm and are located equal distances from the major axis of the tube.
- <sup>u</sup> Under the same conditions as shown in footnote (†) except the test points on the photocathode are separated by 32 mm.
- <sup>v</sup> The center of an image produced on the screen by focusing a test pattern on the optical axis of the photocathode will fall within a circle concentric with the optical axis of the screen having the specified diameter.
- <sup>w</sup> The center of the image produced on the screen of the tube as specified in footnote (v) will not shift more than the specified value during 30 seconds of operation.
- <sup>x</sup> A second magnification value (Emx) is obtained as stated in footnote (v) except the image points on the photocathode are separated by a distance of 32 mm. Per-cent distortion is defined by the equation

$$\text{Per-cent Distortion} = \frac{Emx - Cmx}{Cmx} \times 100$$



## OPERATING CONSIDERATIONS

### Magnetic Shielding

Magnetic shielding of these tubes may be required to minimize the effects of extraneous fields on tube performance. It is to be noted that ac magnetic fields are particularly objectionable in that they seriously impair tube resolution. If an iron or steel case is used, care should be taken to insure that the case is completely demagnetized.

### High Humidity for Types 8605/V1 and 8605/V2

To avoid possible corona effects, it is recommended that these tubes not be operated under conditions of high humidity unless potted in silicone rubber, or equivalent, and that sharp bends in terminal connection leads be avoided.

### DC Power Supply for Types 8605/V1 and 8605/V2

The dc supply voltage for these tubes may be obtained from a suitable high-voltage power-supply unit. Such units are offered commercially by several manufacturers listed in buyers' guides.

## DIMENSIONAL OUTLINE TYPE 8606

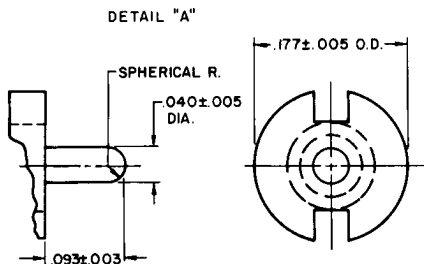

# 8605/V1, 8605/V2, 8606

## DIMENSIONAL OUTLINE TYPE 8606

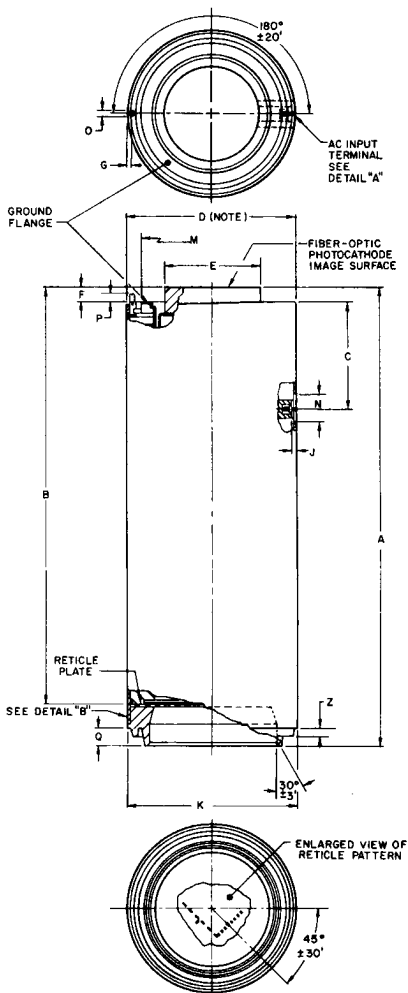

Note: Dimension applies with 1" of tube end.

# 8605/V1, 8605/V2, 8606

## DIMENSIONAL OUTLINE TYPE 8606

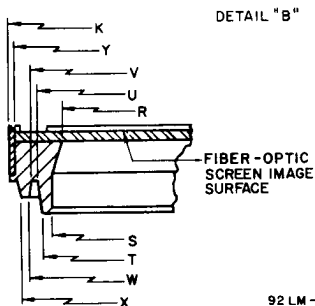

92 LM - 3109

| Dimen-<br>sions | Inches     |            | mm          |             |
|-----------------|------------|------------|-------------|-------------|
|                 | Min.       | Max.       | Min.        | Max.        |
| A               | 11.906     | 12.028     | 302.512     | 305.511     |
| B               | 11.025     | 11.115     | 280.035     | 282.321     |
| C               | 2.372      | 2.398      | 60.249      | 60.909      |
| D               | 3.742 Dia. | 3.747 Dia. | 95.047 Dia. | 95.174 Dia. |
| E               | 2.095 Dia. | 2.105 Dia. | 53.213 Dia. | 53.467 Dia. |
| F               | .237       | .243       | 6.020       | 6.172       |
| G               | .082       | .092       | 2.082       | 2.336       |
| J               | .093       | .113       | 2.362       | 2.870       |
| K               | 3.737 Dia. | 3.747 Dia. | 94.92 Dia.  | 95.10 Dia.  |
| M               | 2.950 Dia. | 3.050 Dia. | 74.930 Dia. | 77.470 Dia. |
| N               | .620 Dia.  | .630 Dia.  | 15.748 Dia. | 16.002 Dia. |
| O               | .120 Dia.  | .123 Dia.  | 3.048 Dia.  | 3.124 Dia.  |
| P               | .208       | .218       | 5.283       | 5.537       |
| Q               | .370       | .380       | 9.398       | 9.652       |
| R               | 2.51 Dia.  | 2.55 Dia.  | 63.75 Dia.  | 64.77 Dia.  |
| S               | 2.781 Dia. | 2.791 Dia. | 70.637 Dia. | 70.891 Dia. |
| T               | 2.979 Dia. | 2.994 Dia. | 75.666 Dia. | 76.047 Dia. |
| U               | 3.083 Dia. | 3.098 Dia. | 78.308 Dia. | 78.689 Dia. |
| V               | 3.245 Dia. | 3.260 Dia. | 82.423 Dia. | 82.804 Dia. |
| W               | 3.297 Dia. | 3.312 Dia. | 83.743 Dia. | 84.124 Dia. |
| X               | 3.500 Dia. | 3.520 Dia. | 88.900 Dia. | 89.408 Dia. |
| Y               | 3.54 Dia.  | 3.58 Dia.  | 89.91 Dia.  | 90.93 Dia.  |
| Z               | .183       | .193       | 4.648       | 4.902       |

The dimensions in millimeters are derived from the basic inch dimensions (1 inch = 25.4 mm).

# 8605/V1, 8605/V2, 8606

## SCHEMATIC ARRANGEMENT OF TYPE 8606

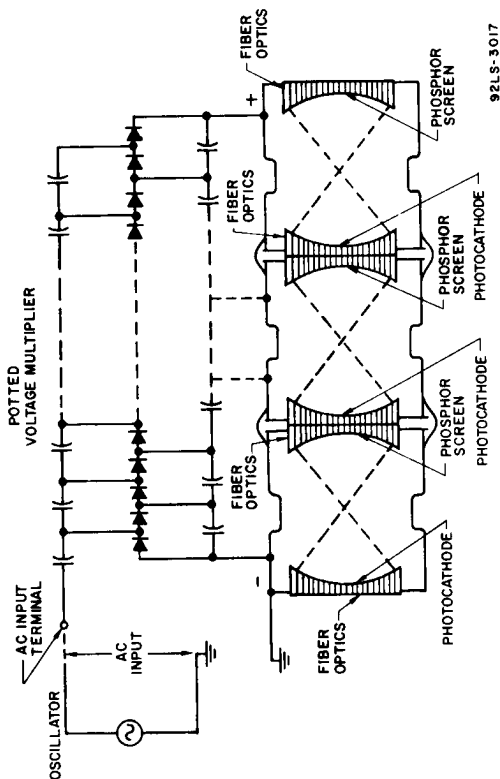

# 8605/V1, 8605/V2, 8606

## DIMENSIONAL OUTLINE TYPES 8605/V1 AND 8605/V2

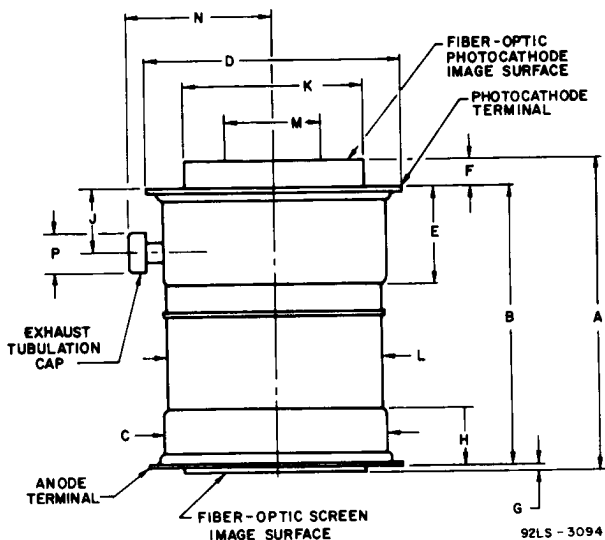

92LS - 3094

| Dimensions | Inches                | mm                  |
|------------|-----------------------|---------------------|
| A          | $3.690 \pm .015$      | $93.7 \pm .4$       |
| B          | 3.337                 | 84.8                |
| C          | $2.600 \pm .015$ Dia. | $66 \pm .4$ Dia.    |
| D          | $3.00 \pm .05$ Dia.   | $76.2 \pm 1.3$ Dia. |
| E          | 1.15                  | 29.2                |
| F          | $.320 \pm .020$       | $8.13 \pm .51$      |
| G          | $.042 \pm .02$        | $1.1 \pm .5$        |
| H          | .70                   | 17.8                |
| J          | $.77 \pm .03$         | $19.6 \pm .8$       |
| K          | $2.100 \pm .005$ Dia. | $53.3 \pm .13$ Dia. |
| L          | 2.50 Dia.             | 63.5 Dia.           |
| M          | 1.575 Min. Dia.       | 40 Min. Dia.        |
| N          | 1.70 Max. R.          | 43.2 Max. R.        |
| P          | .55 Dia.              | 14 Dia.             |

The dimensions in millimeters are derived from the basic inch dimensions (1 inch = 25.4 mm).

# 8605/V1, 8605/V2, 8606

## TYPICAL RESOLUTION CHARACTERISTICS FOR ALL TYPES

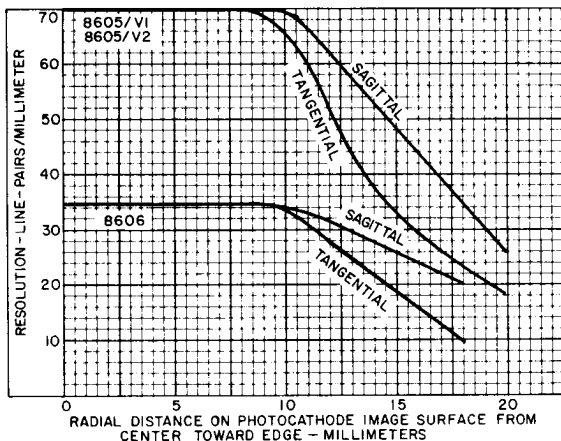

## TYPICAL RESOLUTION CHARACTERISTICS FOR TYPES 8605/V1 AND 8605/V2

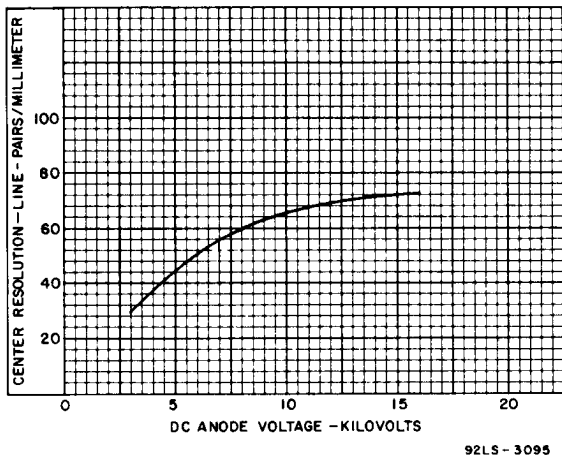

# 8605/V1, 8605/V2, 8606

## LUMINANCE GAIN AS A FUNCTION OF VOLTAGE FOR TYPE 8606

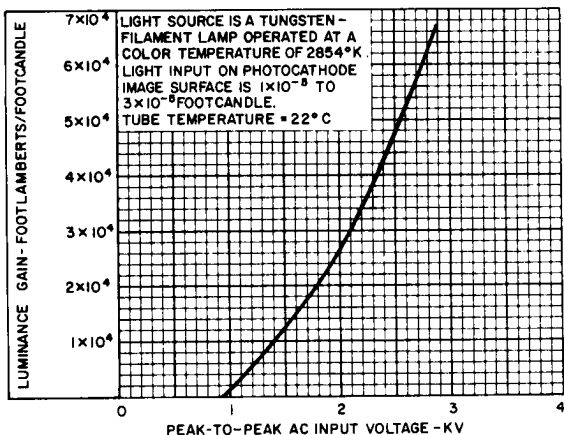

92LS-3096

## RELATIVE LIGHT OUTPUT CHARACTERISTIC FOR TYPES 8605/V1 AND 8605/V2

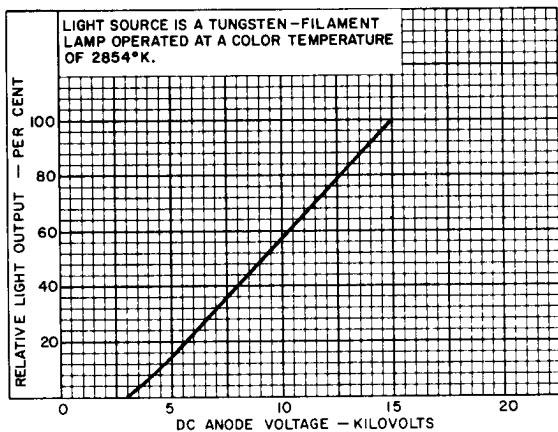

92LS-3103

# 8605/V1, 8605/V2, 8606

TYPICAL SPECTRAL RESPONSE CHARACTERISTIC FOR ALL TYPES

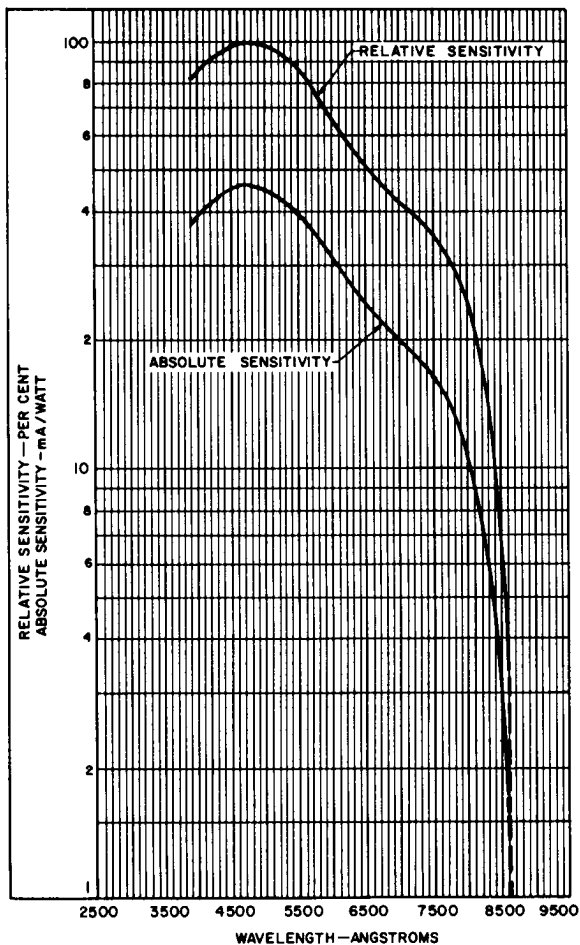

92 LM - 3108



# 8605/V1, 8605/V2, 8606

SPECTRAL ENERGY EMISSION CHARACTERISTICS  
(JEDED PHOSPHOR P20) FOR ALL TYPES

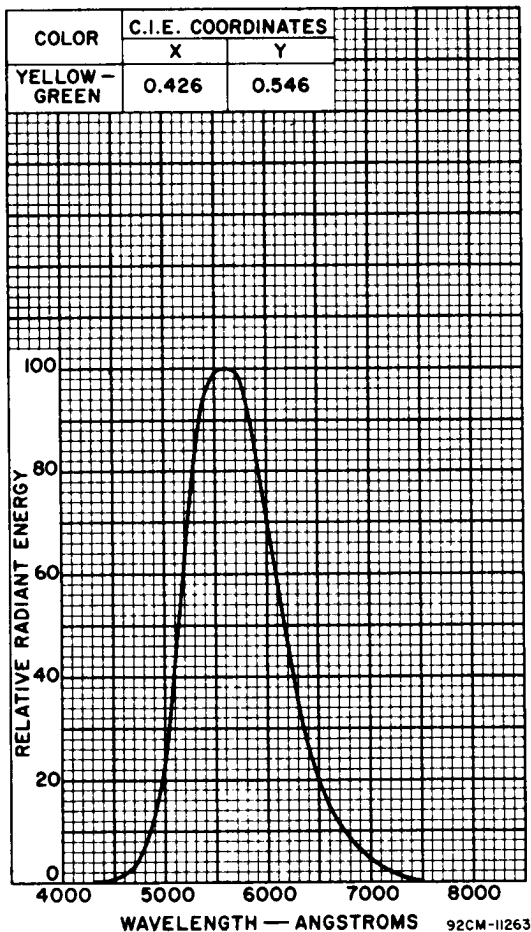

# 8605/V1, 8605/V2, 8606

## TYPICAL MODULATION TRANSFER FUNCTION VERSUS FREQUENCY FOR TYPE 8606

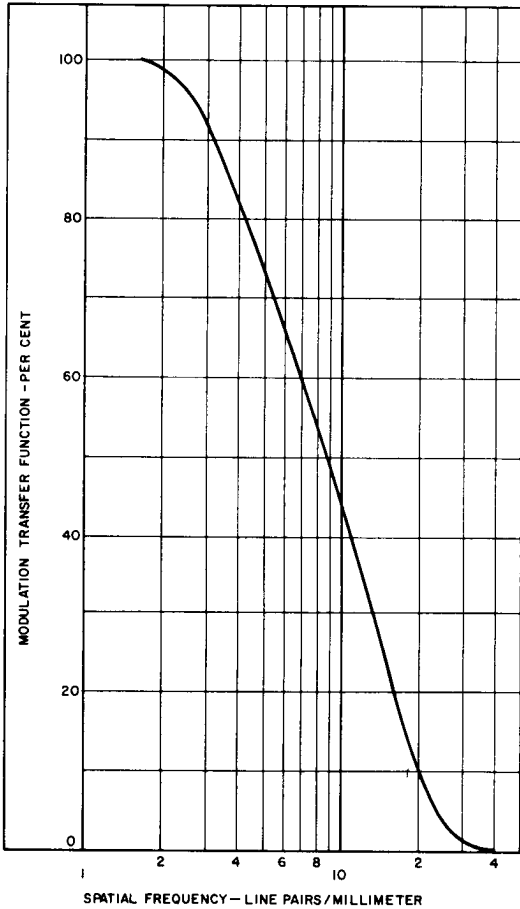

92LM-3101

# 8605/V1, 8605/V2, 8606

## TYPICAL MAGNIFICATION AND DISTORTION CHARACTERISTICS FOR TYPE 8606

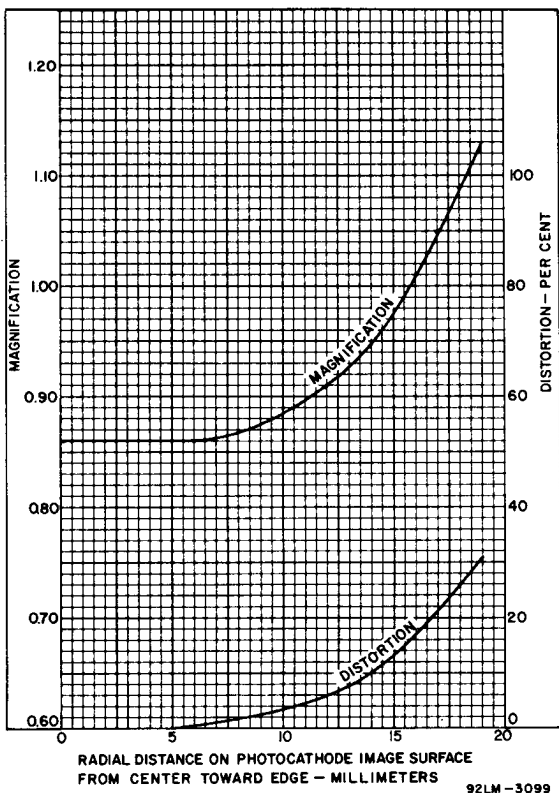

# 8605/V1, 8605/V2, 8606

## CONTRAST TRANSFER CHARACTERISTICS FOR TYPES 8605/V1 AND 8605/V2

