

Beam Power Tube

For Pulse-Modulator Service
under Severe Shock and Vibration

GENERAL DATA

Electrical:

Heater, for Unipotential Cathode:

Voltage (AC or DC)	6.3 ± 10%	volts
Current at heater volts = 6.3.	1.25	amp
Transconductance, for plate volts = 200, grid-No.2 volts = 200, and plate ma. = 100.	7000	μmhos
Mu-Factor, Grid No.2 to Grid No.1 for plate volts = 200, grid-No.2 volts = 200, and plate ma. = 100	4.5	
Direct Interelectrode Capacitances: ^a		
Grid No.1 to plate	0.24 max.	μf
Grid No.1 to cathode & grid No.3 & internal shield, grid No.2, base sleeve, and heater.	13.0	μf
Plate to cathode & grid No.3 & internal shield, grid No.2, base sleeve, and heater.	8.5	μf

Mechanical:

Operating Position	Any
Maximum Overall Length	3-13/16"
Seated Length	3-1/8" ± 1/8"
Maximum Diameter	1-21/32"
Weight (Approx.)	2 oz
Bulb	T12
Cap.	Small (JEDEC No.C1-1)
Socket	Standard Octal 8-Contact
Base	Small-Micanol-Wafer Octal 8-Pin with "770" Sleeve (JEDEC Group 1, No.BB-150)

Basing Designation for BOTTOM VIEW 7CK ←

Pin 1 - Cathode, Grid No.3, Internal Shield	Pin 5 - Grid No.1
Pin 2 - Heater	Pin 6 - Same as Pin 1
Pin 3 - Grid No.2	Pin 7 - Heater
Pin 4 - Same as Pin 1	Pin 8 - Base Sleeve
	Cap - Plate



AA' = PLANE OF ELECTRODES

MODULATOR — Rectangular-Wave Modulation

Maximum and Minimum CCS^b Ratings, Absolute-Maximum Values:

For duty factor^c between 0.001 and 1 and maximum averaging time of 10,000 μsec in any interval

DC PLATE SUPPLY VOLTAGE (E _{bb}) ^d	See Rating Chart 1
INSTANTANEOUS PLATE VOLTAGE.	115% of E _{bb}

← Indicates a change.



DC GRID-No.2 SUPPLY VOLTAGE ^d	500 max.	volts
DC GRID-No.1 SUPPLY VOLTAGE ^d	} 300 max. Minimum—See <i>Rating Chart I</i>	volts
GRID-No.1 VOLTAGE:		
Instantaneous—negative value	400 max.	volts
Peak—positive value.	100 max.	volts
PEAK PLATE CURRENT	See <i>Rating Chart II</i>	
PEAK GRID-No.2 CURRENT	0.75 max.	amp
PEAK GRID-No.1 CURRENT	0.5 max.	amp
PLATE INPUT.	80 max.	watts
GRID-No.2 INPUT.	1.75 max.	watts
GRID-No.1 INPUT.	0.5 max.	watt
PLATE DISSIPATION ^a	See <i>Rating Chart I</i>	
PEAK HEATER-CATHODE VOLTAGE:		
Heater negative with respect to cathode	135 max.	volts
Heater positive with respect to cathode	135 max.	volts
BULB TEMPERATURE (At hottest point on bulb surface)	220 max.	°C

Typical Operation:

With rectangular-wave shapes in accompanying test circuit and with duty factor^c of 0.01

DC Plate Supply Voltage.	3000	volts
DC Grid-No.2 Supply Voltage.	300	volts
DC Grid-No.1 Supply Voltage.	-175	volts
Peak-Positive Grid-No.1 Voltage.	65	volts
Plate Current:		
Peak	1.5	amp
Average.	0.015	amp
DC Grid-No.2 Current	0.004	amp
DC Grid-No.1 Current	0.0025	amp
Load Resistance (R_L), 100 watts, non-inductive.		
	1500 ± 5%	ohms
Coupling Capacitor (C_3).	0.25 (5000 v dc)	μf

Maximum Circuit Values:

Grid-No.1-Circuit Resistance	3000 max.	ohms
--	-----------	------

^a Without external shield.

^b Continuous Commercial Service.

^c *Duty Factor* for the 7358 is defined as the "on" time in microseconds divided by 10,000 microseconds.

"On" time is defined as the sum of the durations of all the individual pulses which occur during any 10,000-microsecond interval.

"Pulse Duration" is defined as the time interval between the two points on the pulse at which the instantaneous value is 70 per cent of the peak value. The peak value is defined as the maximum value of a smooth curve through the average of the fluctuations over the top portion of the pulse.

^d For tube protection, it is essential that sufficient resistance be used in the plate supply circuit, the grid-No.2 supply circuit, and the grid-No.1 supply circuit so that the short-circuit current is limited to 0.5 ampere in each circuit.

^e Averaged over any interval not exceeding 10,000 microseconds. Care should be used in determining the plate dissipation. A calculated value based on rectangular pulses can be considerably in error when



the actual pulses have a finite rise and fall time. Plate dissipation should preferably be determined by measuring the bulb temperature under actual operating conditions; then, with the tube in the same socket and under the same ambient-temperature conditions, apply to the tube sufficient dc input to obtain the same bulb temperature. This value of dc input is a measure of the plate dissipation.

CHARACTERISTICS RANGE VALUES FOR EQUIPMENT DESIGN

	Note	Min.	Max.	
Heater Current	1	1.175	1.325	amp
Direct Interelectrode Capacitances:				
Grid No.1 to plate	2	-	0.24	$\mu\mu\text{f}$
Grid No.1 to cathode & grid No.3 & internal shield, grid No.2, base sleeve, and heater	2	12.0	15.0	$\mu\mu\text{f}$
Plate to cathode & grid No.3 & internal shield, grid No.2, base sleeve, and heater	2	7.3	9.5	$\mu\mu\text{f}$
Mu-Factor, Grid No.2 to Grid No.1	1,3	3.6	5.4	
Plate Current	1,4	46	94	ma
Grid-No.2 Current	1,4	0	5.5	ma
Peak Plate Current	1,5	2.4	-	amp
Heater-Cathode Leakage Current:				
Heater 100 volts negative with respect to cathode	1	-	100	μa
Heater 100 volts positive with respect to cathode	1	-	100	μa

Note 1: With 6.3 volts ac on heater.

Note 2: Without external shield.

Note 3: With dc plate volts = 200, dc grid-No.2 volts = 200, and dc grid-No.1 voltage adjusted to give dc plate current of 100 ma.

Note 4: With dc plate volts = 300, dc grid-No.2 volts = 200, and dc grid-No.1 volts = -33.

Note 5: With the tube in the accompanying test circuit under the following conditions: rectangular-wave modulation (e_{g1}) applied to grid No.1; pulse duration of 1 microsecond approx.; pulse-repetition rate (approx. 3000 pps) adjusted to give dc plate current of 9 ma. minimum; dc plate supply volts = 3500; dc grid-No.2 supply volts = 500 applied simultaneously with the plate voltage; dc grid-No.1 supply volts = -300; peak-positive grid-No.1 swing of 100 volts; coupling capacitor (C_3) having value of 0.1 μf , 5000 volts dc; and load resistance (R_L) of 1000 \pm 5% ohms, 50 watts, non-inductive.

SPECIAL TESTS & PERFORMANCE DATA

500-g Shock Test:

This test is performed on a sample lot of tubes from each production run. Tubes are held rigid and are subjected in four different positions to an impact acceleration of 500 g. At the end of this test, tubes are required to meet the following limits:

Peak Plate Current 2.4 min. amp

For conditions shown under *Characteristics Range Values*.

← Indicates a change.



Heater-Cathode

Leakage Current. . . . See *Characteristics Range Values*

The tubes must also meet the established limit for low-frequency vibration (See below).

Fatigue Test:

This test is performed on a sample lot of tubes from each production run. Tubes are rigidly mounted and subjected to 2.5 g vibrational acceleration at 25 cycles per second for 32 hours in each of three positions. At the end of this test, tubes are required to meet the following limits:

Peak Plate Current 2.2 min. amp

For conditions shown under *Characteristics*

Range Values.

Heater-Cathode

Leakage Current. . . . See *Characteristics Range Values*

The tubes must also meet the established limit for low-frequency vibration (See below).

Low-Frequency Vibration Performance:

This test is performed on a sample lot of tubes from each production run under the following conditions: Heater volts = 6.3, plate supply volts = 250, grid-No.2 volts = 200, grid-No.1 voltage varied to give a plate current of 10 milliamperes, plate load resistor (ohms) = 2000 and vibrating frequency of 25 cycles per second with a fixed amplitude of 0.040 inch (total excursion 0.080 inch). The rms output voltage across the plate load resistor as a result of vibration of the tube must not exceed 500 millivolts.

Variable-Frequency Vibration Performance (1):

This test is performed on a sample lot of tubes from each production run. Tubes are vibrated in each of 3 positions through frequency range of from 10 to 50 cycles per second and back to 10 cycles per second. The tubes are vibrated under the same conditions as specified for *Low Frequency Vibration Performance*. During the test, the tubes will not show an rms output voltage across the plate load resistor in excess of 500 millivolts. At the end of this test, the tubes will not show defects that cause the tubes to be inoperable.

Variable-Frequency Vibration Performance (2):

This test is performed on a sample lot of tubes from each production run. Tubes are vibrated in each of 3 positions, perpendicular and parallel to major axis of the tube, and parallel to longitudinal axis of the tube, through the frequency range from 50 to 120 cycles per second at a fixed acceleration of 10 g under the same voltage, current and load conditions as specified for *Low Frequency Vibration Performance*. During this test, the tubes will not show an rms output voltage across the plate load resistor in excess of 500 millivolts.

OPERATING CONSIDERATIONS

The *bulb* becomes hot during operation. To insure adequate cooling, therefore, it is essential that free circulation of air be provided around the 7358.

The *plate* shows no color when operated with maximum rated dissipation. Connection to the plate cap should be made with a flexible lead to prevent any strain on the seal of the cap.

For *tube protection*, it is essential that sufficient resistance be used in the plate supply circuit, the grid-No.2 supply circuit, and the grid-No.1 supply circuit so that the short-circuit current is limited to 0.5 ampere in each circuit.

The *accompanying test circuit* requires the use of damping resistors to suppress oscillations which may be caused by the rectangular-wave signal. These resistors should be non-inductive and they should be placed as close as possible to the socket terminals.



TEST CIRCUIT FOR TYPE 7358

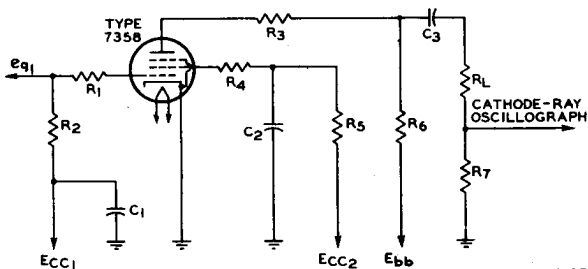

92CS-8015RI

C_1 : 0.1 μ f, 600 v dc.

C_2 : 2 μ f, 600 v dc.

C_3 : For values, See *Typical Operation and Characteristics Range Values (Note 5)*.

R_1 : 20 ohms, 1 watt, non-inductive.

R_2 : 30,000 ohms, 1 watt.

R_3 : 10 ohms, 5 watts, non-inductive.

R_4 : 25 ohms, 1 watt, non-inductive.

ECC₁: Grid-No.1 Supply Voltage.

ECC₂: Grid No.2 Supply Voltage.

E_{bb}: Plate Supply Voltage.

eg₁: Rectangular-Wave Signal Voltage.

R_5 : 1000 ohms, 1 watt.

R_6 : 10,000 ohms, 50 watts.

R_7 : 30 \pm 1% ohms, 5 watts, non-inductive.

R_L : For values, See *Typical Operation and Characteristics Range Values (Note 5)*.

Information furnished by RCA is believed to be accurate and reliable. However, no responsibility is assumed by RCA for its use; nor for any infringements of patents or other rights of third parties which may result from its use. No license is granted by implication or otherwise under any patent or patent rights of RCA.



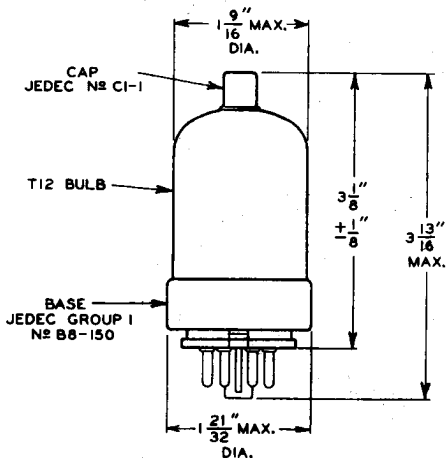

92CS-9625R4



RATING CHART I

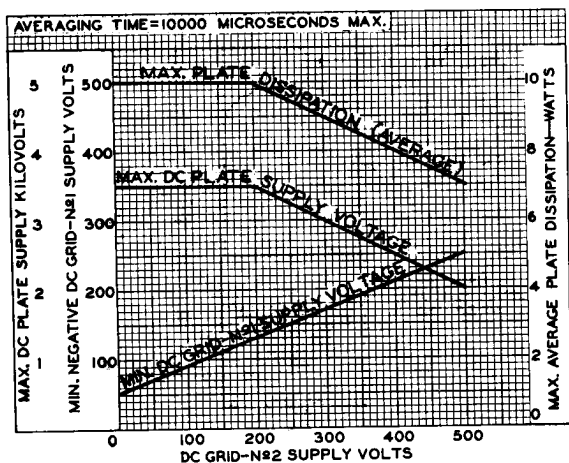

92CS-8012R1

RATING CHART II

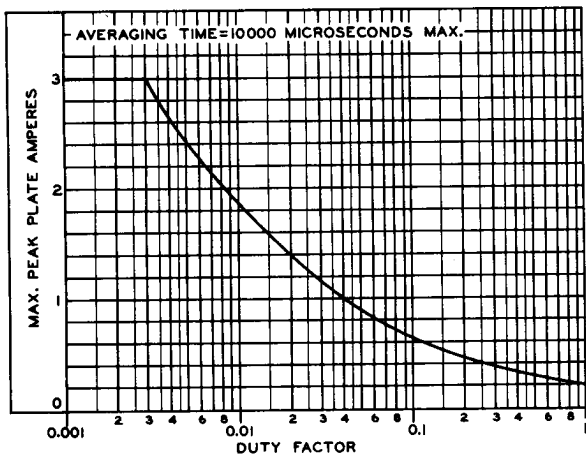

92CS-8014R1





7358

7358

TYPICAL PLATE CHARACTERISTICS

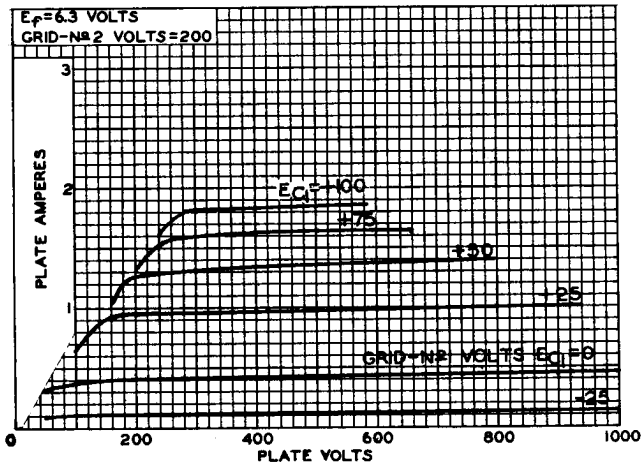

92CS-10124

TYPICAL CHARACTERISTICS

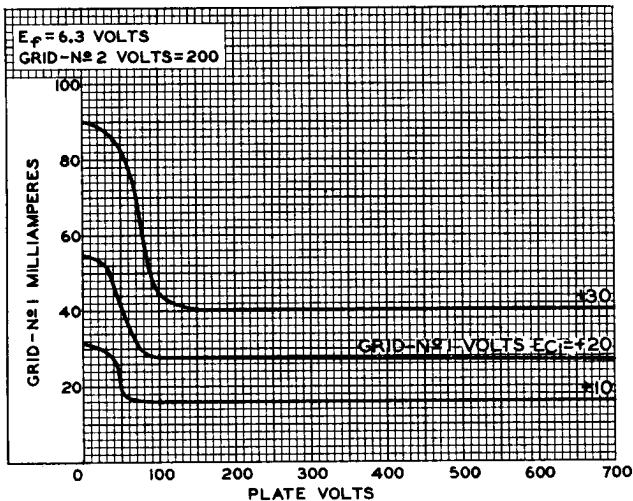

92CS-9617

7358



7358

TYPICAL CHARACTERISTICS

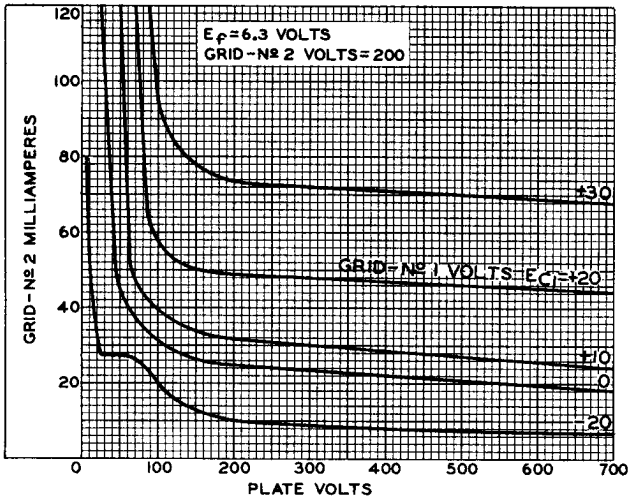

92CS-9618

TYPICAL PLATE CHARACTERISTICS

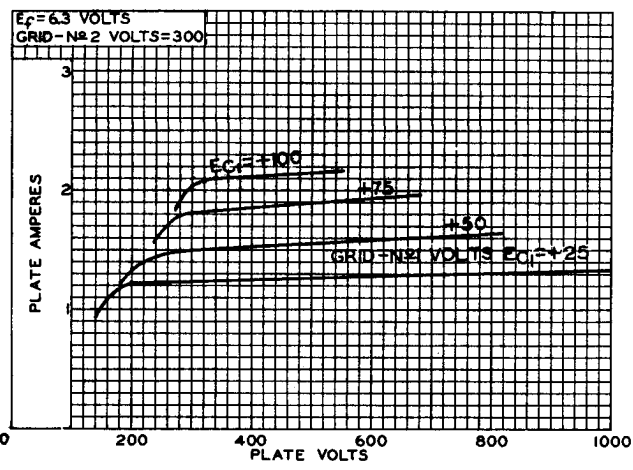



7358

7358

TYPICAL PLATE CHARACTERISTICS

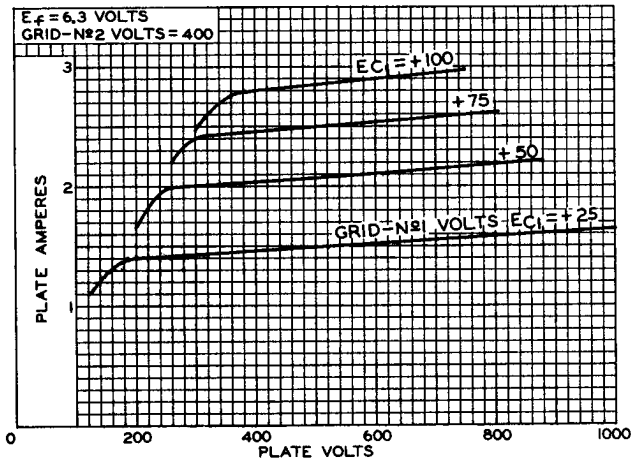

92CS-10131

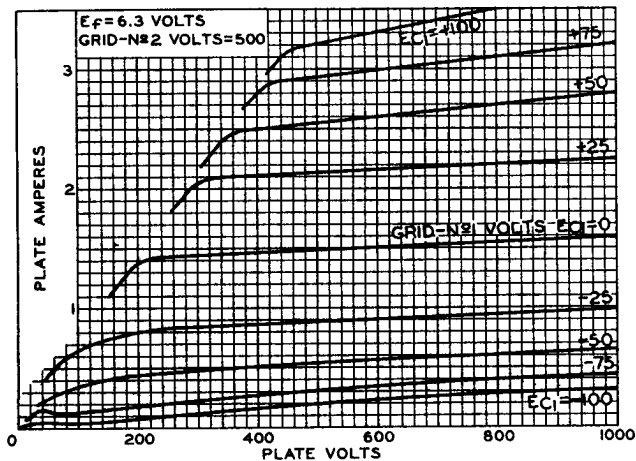



7358

TYPICAL CHARACTERISTICS

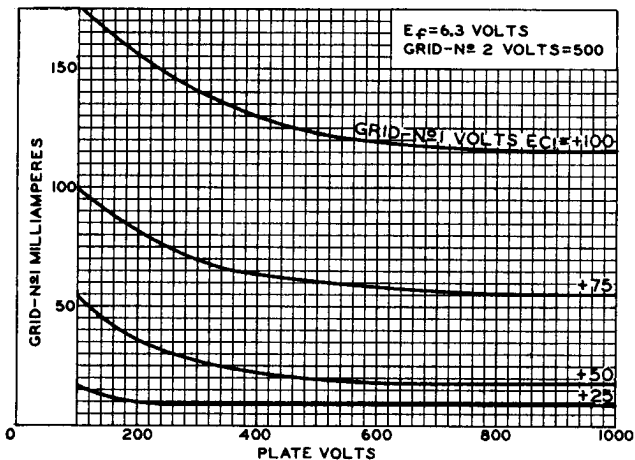

92CS-10129

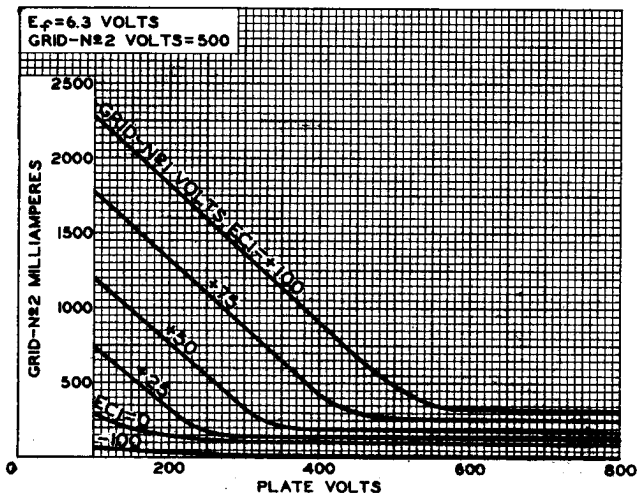

92CS-10130