

talks

on

its application to radio and light

electricity

Introduction

When an original sample of "Educational Letters" came into our hands, we were struck — in the same way as thousands and thousands of readers before us — by tone and set-up of this excellent book. We were glad to see that complicated material like this had been worked out in such a simple and clear way. This impression was strengthened when reading further. Therefore we were only too happy to accept the proposition to adapt this book to our particular wants and to publicize this best-seller once again in English, Spanish and other languages. Our aims remained the same: to edit a popular-scientific book; to give sufficient and a right quantity of technical information to the potter, to the radio amateur, to every lay-man interested. Not too much, not too complicated, just sticking to the essential subjects. Main points are clarified by means of a text and simple drawing. We have brought this book up-to-date by adding such subjects as Transistors, Television, Frequency Modulation and others. We hope to have succeeded in our endeavour. To all who gave their spontaneous co-operation we wish to express our sincere thanks.

N.V. PHILIPS' GLOEILAMPENFABRIEKEN
Direct Export Department



Th. W. Kreek

Revised edition of "Lehrbriefe" written and edited by Mr. Gustav H. Büscher of Philips G.m.b.H. in Germany.

Published by:

N.V. Philips' Gloeilampenfabrieken, Direct Export Department,
Netherlands

with the co-operation of:

Dr. S. D. Boon *Electronic Tube Division*

Mr. E. Rodenhuis *Electronic Tube Division*

Mr. P. L. J. Roosch *Main Industry Group Light*

Mr. J. L. van Schaik *Main Industry Group Apparatus*

Mr. G. Westerveen *Main Industry Group ELA*

Editor: A. P. van Boxsel

Printers: Teulings' Grafisch Bedrijf N.V., 's-Hertogenbosch

CONTENTS

Chapter one:

A CLOSED BOOK IS OPENED

	Page
A: Some fundamentals of electricity	1
B: Something about resistances and "ohms"	13
C: Alternating current	16
D: Rectifying	28

Chapter two:

RADIO ENGINEERING

A: Radio waves	42
B: Sound waves	48
C: Transmission and reception	56
D: Broadcast receivers and fundamentals	64
E: Introduction to radio tubes	78
F: The single-tube receiver	90
G: More tubes — better reception!	102
H: More theory	106
I: F.M. reception	126
J: Coils and inductance	140
K: Capacitors and capacitance	145
L: The necessity of bandspread	156
M: Sound distribution in our homes	161

Chapter three:

SOUND IN ALL ITS FORMS

A: From microphone via amplifier to loudspeaker	163
B: Microphones	171
C: Amplifiers	190
D: Loudspeakers	202
E: Demonstration of public address and music installations	217
F: Transistors	227
G: Television	230

Chapter four:

LIGHT AND LIGHTING

A: General fundamentals	233
B: Technical terminology and measuring units in illuminating engineering	242

C:	Filament lamps	256
D:	Photo-lamps	291
E:	Gas-discharge lamps	311
F:	Metallic-vapour lamps	323
G:	Low-pressure tubular fluorescent lamps	343
H:	Lamps and their applications	368
I:	Computing and designing of lighting installations . .	375
J:	Practical examples of lighting installations and their basic calculations	387
K:	Bactericidal or germicidal lamps	399

Chapter five:

ULTRA-VIOLET AND INFRA-RED RADIATION

A:	The "Infraphil" lamp	409
B:	The Infra-red heat and drying lamp	415

CHAPTER ONE:

A CLOSED BOOK IS OPENED

A: Some fundamentals of electricity

A closed book?

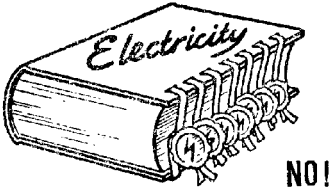

Anyone who sells electrical equipment should have at least some knowledge of electrical engineering, because he constantly comes across people who are "in the picture". Any knowledge acquired on the subject will make you feel more comfortable and self-assured.

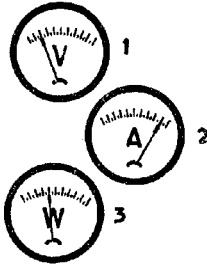

1 = voltmeter. 2 = ammeter.
3 = wattmeter.

Wherever you turn you will come across the expressions "Volt", "Ampere" and "Watt". They indicate certain properties of electric current, just as length, width and depth denote certain properties of a box.

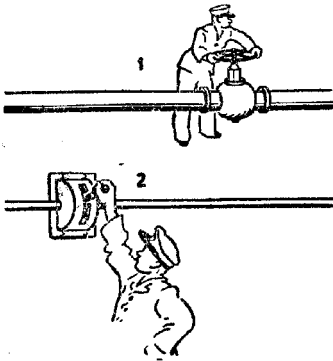

1 = water pipe line.
2 = line for electric current.

Electric current flows invisibly through metal wires. The mystery of the nature of electric currents is quickly understood if they are compared with visible water currents flowing through pipes.

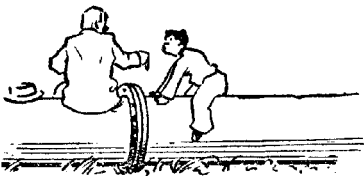

Line for a large volume of water.

If a large volume of water is to be passed through a pipe line, the pipe must have a large cross-section.

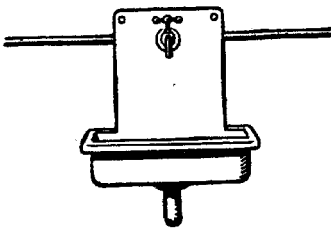

This pipe will only allow small quantities of water to pass.

Pipe for a small volume of water.

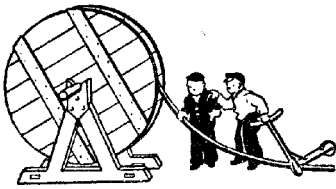

The same applies in the case of electricity: strong electric currents require lines of large cross-section.

*A lot of current can flow through this cable.
"A large number of Amperes!"*

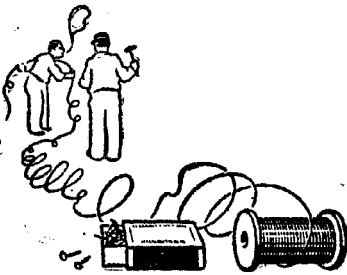

Small electric currents only need a thin line and can be passed from one point to another through thin wires.

"Just the right wire for my electric bell!"

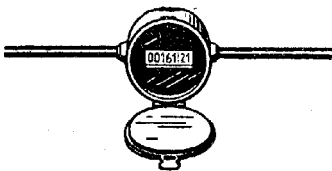

The volume of water which, within a certain space of time, flows through a water line can be measured by means of a specially designed "water meter", which is incorporated in the pipe line.

Water meter.

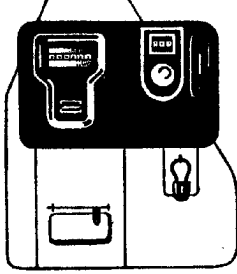

Current meter.

"Ampere"
Unit of measurement
of electric current
(Abbreviated "A")

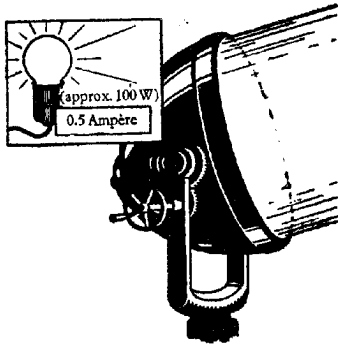

The quantity of electricity flowing through a line can be read off from a measuring instrument connected in the line.

Lengths are measured in feet, liquids in gallons, weights in ounces or pounds and electric current densities can likewise be measured in "Amperes" or, in the case of small current densities, in milliamperes, i.e. one thousandths of an ampere.

Through an electric incandescent lamp, for example, an electric current of about half an ampere passes. It will be clear that through the light source of a large floodlight much more current will pass. The illustration shows a floodlight which requires a current density of 100 amperes for satisfactory operation.

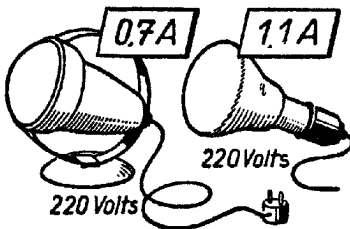

Infraphil.

*Infra-red
drying lamp*

The "Infraphil" heat radiator, for example, requires a current of about 0.7 ampere, while the Infra-red drying lamp needs a current of a little over 1 ampere — at a voltage of 220 volts.

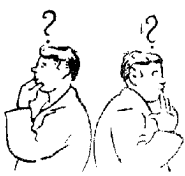

Now, this is where we are likely to trip up: "Volts" and "Tension"!

Volts? Tension?

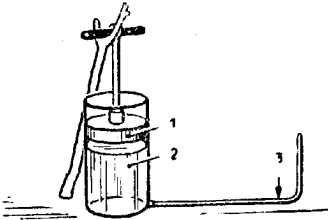

Let us return to the comparison with water. Water can only pass through a pipe line if it is forced through. "But", you will say, "there is nothing to force a flowing brook or a river". Wrong! In this case the force or pressure is provided by the weight of the water and the head (difference in height). But we won't concern ourselves with this now. The illustration on the left

No pressure.
 1 = piston. 2 = water. 3 = tubing.

represents a cylindrical vessel filled with water and a piston with the aid of which pressure can be exerted on the water. A tube is connected to the vessel. The water will not flow from the upright part of the tube, provided of course this extends above the level of the water in the vessel.

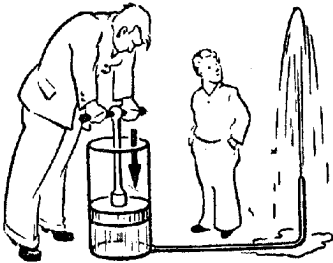

Now pressure is exerted on the piston. The water starts to flow and squirts like a fountain from the opening of the tube.

High pressure.

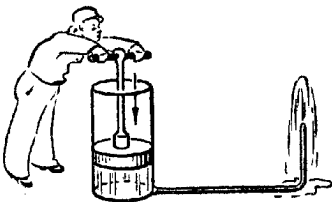

The lower the pressure, the lower the height of the water column of the fountain will be.

Low pressure.

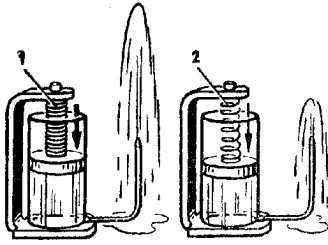

1 = spring with high tension. 2 = spring with low tension.

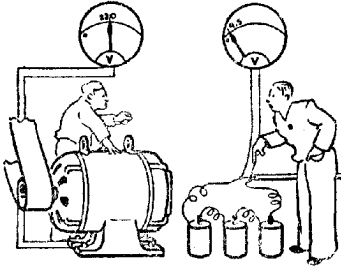

Generator. Battery.

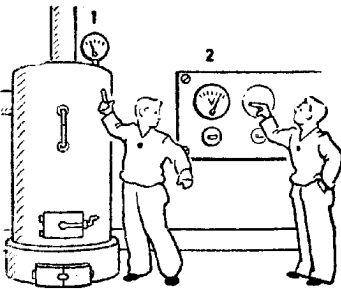

1 = pressure gauge. 2 = voltmeter.

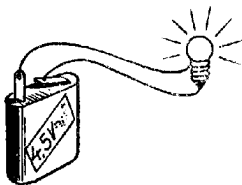

A 4.5 V bulb burns at a tension of 4.5 V. A torch battery supplies a tension of 4.5 V.

Instead of man power, we can also use a spring to exert pressure. A spring with a high tension will cause a high pressure and the reverse is the case if the tension of the spring is low. This comparison is only valid, of course, if the two vessels have the same dimensions.

Electric pressure is called "Tension". It is generated in electric machines of a certain type (generators) and also in so-called "cells" and "batteries".

The magnitude of electric pressure — from now on we will refer to "tension" only — is measured in volts (abbr. "V"). Just as steam pressure is measured with a pressure gauge, the tension of electric current is measured with a "Voltmeter" (tension meter).

A flashlamp battery produces only a low tension. It is generally 4.5 V.

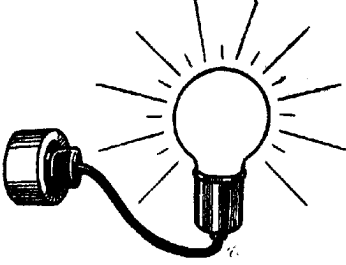

Tension 220 volts.

The current which flows through the wires of the mains supply may have a tension of 220 volts. (Other tensions are also encountered.)

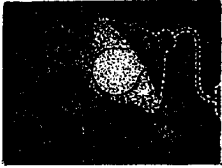

220-volt bulb on 110-volt supply.

If a 220-volt lamp is connected to a 110-volt mains supply it will produce only a weak glow, the electric tension being too low to make it burn at full power.

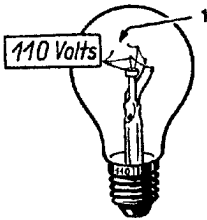

The 110V filament (=1) has fused because this bulb was connected to a 220-volt supply.

If on the other hand a 110-volt bulb is connected to a 220-volt mains supply, it will light up for a very short time and then go out. The filament is unable to withstand the strong current resulting from the high tension, and fuses.

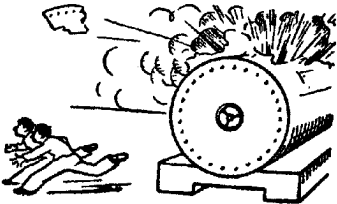

A steam boiler will also burst if the steam pressure becomes excessive.

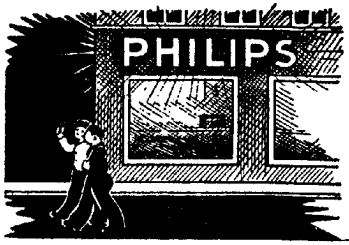

There are tensions much higher than 220 volts. The brightly coloured tubes of neon signs, for example, operate at a tension of 5,000 volts.

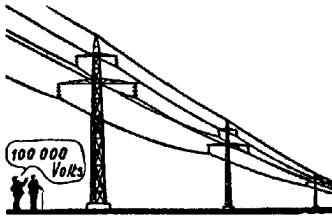

The heavy wires of overhead systems carry currents at tensions of 100,000 volts and more.

Danger! High Tension!
Very high pressure: tension of 100,000 volts.

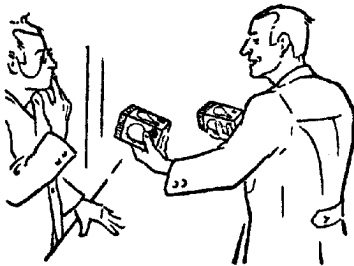

How many watts?

Now we know at least something about "amperes" and "volts". If a customer comes in to buy a lamp, he will not ask about amperes. All the assistant needs to know is what the tension of the mains supply in question is, thus whether it is 110 or 220 volts. The customer will ask for a 25-watt lamp or a 60-watt lamp or even a 100-watt "bulb".

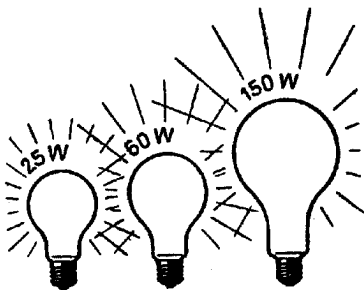

25 watts. 60 watts. 150 watts.

The term "watt" always turns up when it is desired to furnish information regarding the "power" of electrical equipment. A 100-watt lamp is more powerful than a 25-watt lamp, since it gives a much brighter light, while a 150-watt lamp burns more brightly still. Thus, the watt is a unit of measure for power.

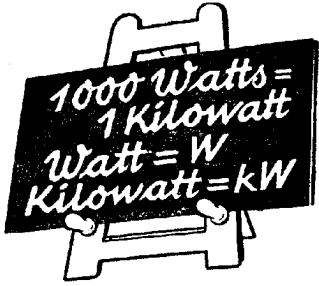

Large powers are not measured in watts, but in "kilowatts"; 1,000 watts equal 1 kilowatt, just as 1,000 grams equal 1 kilogram. Watt is abbreviated to "W" and kilowatt to "kW". Note that a small letter "k" is used, as in kilogram (kg).



Low pressure. High pressure.

In both cases the same volume of water.

Another comparison will make it easier to understand the notion "power". The illustration shows two identical fountains. The water column of the one rises to only a relatively small height, because the pressure which forces the water from the aperture is small. The column of the second fountain rises very high, because the water is under considerable pressure. It will be quite clear that in the latter case the power is greater than in the former.

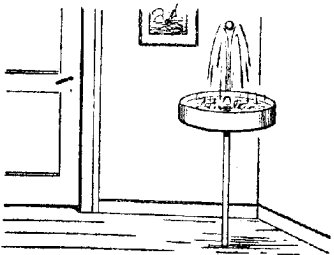

The power, however, is not solely dependent upon the water pressure, but also on the flowing volume of water. A small room fountain with a low water consumption has not, of course, the same power as the large fountains in public gardens. (Pressure and water volume are small.)

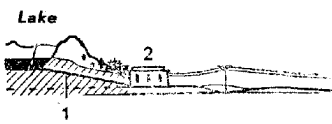

- 1=*thin pipe with weak current:
low pressure, low power.*
2=*supply 10 kilowatts.*

only allow a small quantity of water to pass. Thus, the power output of the turbines will also be small so that ultimately a low electric power output results (10 kW).

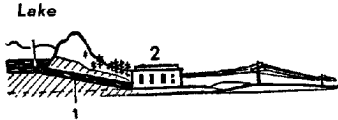

- 1=*wide pipe with strong current:
low pressure, medium power.*
2=*supply 100 kilowatts*

If the narrow pipe is replaced by a pipe of larger cross-section, the power output will be greater (stronger current under the same pressure conditions: output 100 kW).

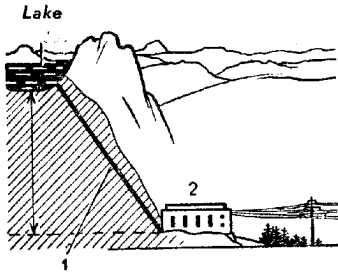

- 1=*weak current with high
pressure: medium power.*
2=*supply 1,000 kilowatts!*

The power output will also be greater when the pressure is higher, i.e. when a greater head is available (weak water current, higher pressure: electric power output 1,000 kW).

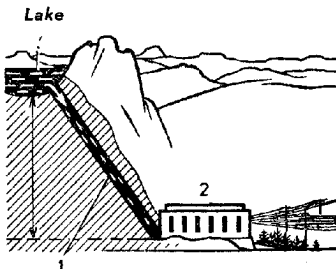

- 1=*strong current with high pres-
sure: high power.*
2=*supply 10,000 kilowatts!*

The power output will be very great if both the current and the pressure are high (strong water current, higher pressure: output 10,000 kW).

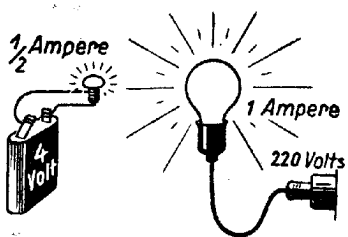

$4 \text{ volts} \times 1/2 \text{ amp.} = 2 \text{ watts.}$
This is low power.

$220 \text{ volts} \times 1 \text{ amp.} = 220 \text{ watts.}$
High power.

It is clearly evident that the power output is determined at once by the current and by the pressure. The same principle applies in the case of electric current: the magnitude of the current density and the value of the tension (pressure) together determine the power output. In practice electric power can be calculated by multiplication of the current density (measured in amperes) and the tension (measured in volts). The result is expressed in "watts" or "kilowatts".

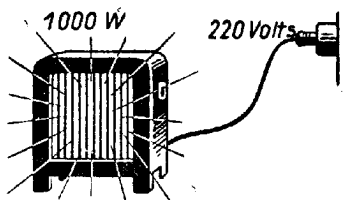

The current flowing in the line is 4.5 amp.

*Power = current \times tension.
 Watt = volt \times ampere.*

Let us assume that the current flowing through the heating element of an electric fire designed for operation on a 220-volt mains supply is 4.5 amperes. The power output of this electric radiator is $220 \times 4.5 =$ roughly 1,000 watts (1 kilowatt).

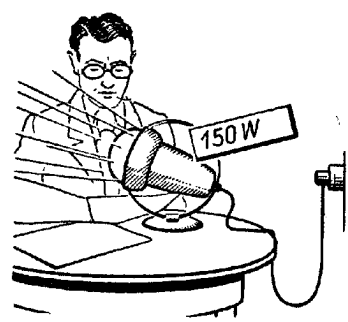

How many amperes?

The power consumption of the Infraphil radiator is 150 watts. The apparatus is connected to a 220-volt mains supply. As the wattage is known, it is easy to calculate the current flowing through the filament of the lamp. This is done by dividing the wattage by the tension: 150 (watts) divided by 220 (volts) equals a current of roughly 0.7 ampere!

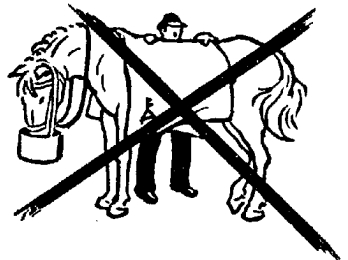

1 h.p. has very little to do with a horse! 1 h.p. = 746 watts.

Whereas electrical engineers express power in watts or kilowatts, mechanical engineers use a different unit of measurement to denote power, namely the horsepower (h.p.). It should be pointed out, however, that a horse is hardly capable of producing the equivalent of 1 h.p. and in fact bears no relation to horsepower at all.

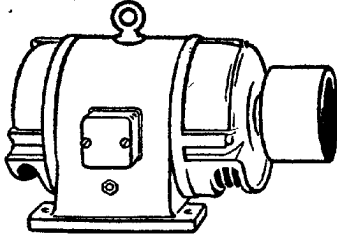

10 h.p. or 7.46 kW.

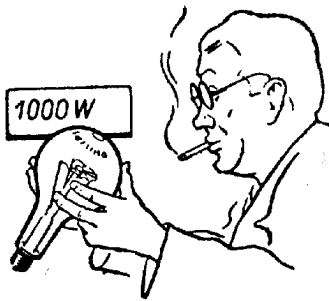

What are the running costs of a 1,000 watts lamp?

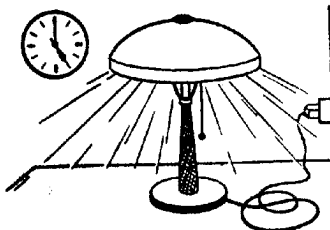
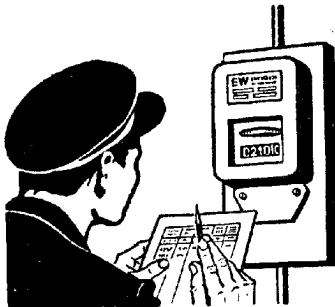

A 100-watt lamp (on since 12 o'clock) has a consumption of 0.5 kWh.

When comparing power values it would be quite wrong to assume that watts or kilowatts and horsepower are easily interchangeable, since 1 kilowatt = 1.34 h.p. and 1 horsepower = 746 watts.

Our knowledge of watts and kilowatts is by no means adequate. If we are asked, for example: "What are the running costs of this 1,000-watt lamp?", we should be able to give the correct answer. Well, we tell the customer that the essential point is how long the lamp or any other electrical equipment will be in operation, in other words how many watts or kilowatts are consumed in a specific period of time.

Electrical engineers work with kilowatt-hours, representing the power consumed during one hour. The electricity companies charge the electric current supplied on the basis of the number of kilowatt-hours (or "units") used.

To revert to the 1,000-watt lamp. If the price of electricity is one penny per kilowatt-hour, we can say with certainty that 1,000 watts (1 kilowatt) consumed in one hour will cost no more and no less than one penny. If the lamp burns for 10 hours, the current consumed during that period will cost tenpence (or 10 d). In a period of five hours a 100-watt lamp consumes: 0.1 (kW) times 5 (hours) equals 0.5 kilowatt-hour (kilowatt-hour is abbreviated to kWh: h = hour).

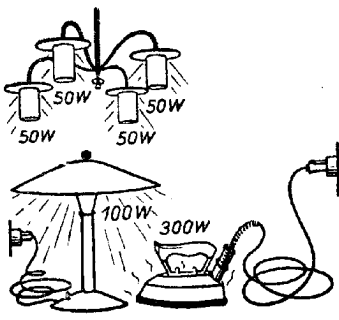

Total power 0.6 kilowatt.
 In three hours $3 \times 0.6 = 1.8$
 kilowatt-hours.

of three hours this amounts to 0.6 kW times 3 hours or 1.8 kilowatt-hours (kWh). At a price of one penny (per kilowatt-hour) the cost is eightpence (or 8 d).

Assuming that in a house a number of lamps or electrical appliances are in use at the same time, the cost of the electricity consumed can be calculated as follows. First the wattages of the individual current-consuming appliances are added up. Thus, if there are four 50-watt lamps in the dining room (together 200 watts), one 100-watt lamp in the study and one 300-watt electric iron in the kitchen, then the total power consumption will be 200 watts + 100 watts + 300 watts = 600 watts = 0.6 kilowatt. For a period

To conclude this chapter a brief summary is given in the table below:

	Measured in	Abbreviation
Current density	amperes	A
Tension	volts	V
Power	watts or kilowatts	W or kW
Current consumption	kilowatt-hours (units)	kWh
Very small current densities	milliamperes (one thousandth of an ampere)	mA
Very small tensions	millivolts (one thousandth of a volt)	mV
Very high tensions	kilovolts	kV

B: Something about resistances and "Ohms"

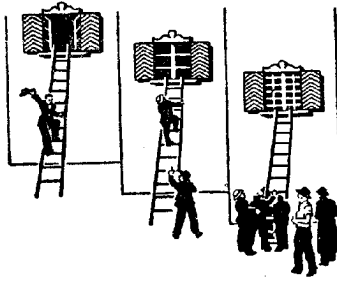

Can you think of any process in which resistance does not occur? Certainly not. There is always some resistance to be overcome. In some cases the resistance is small and in others it is great, while frequently it cannot be overcome at all.



Water flowing through a pipe line will encounter a certain amount of resistance. If this resistance is high, the volume of water flowing through the pipe will be small. This is the case, for example, with narrow pipes or — as shown in the illustration — when the cross-section of a water hose is reduced.

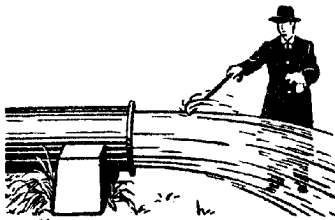

A pipe of large cross-section, on the other hand, will allow a large volume of water to pass, because the resistance is low.

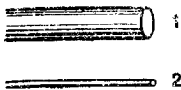

1 = large cross-section, low resistance. 2 = small cross-section, high resistance.

The same applies in the case of electric currents. The resistance is lower according as the cross-section of the conductor is greater.

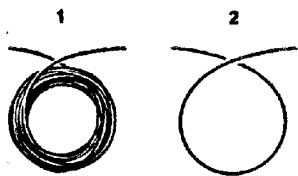

1 gives a high and 2 gives a low resistance between beginning and end.

Copper
Aluminium
Zinc
Iron

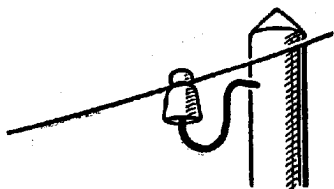

$\Omega = \text{Ohm}$
1000 Ohm = 1 Kilohm =
K Ω . 1000000 Ω =
1 Megohm = M Ω

The magnitude of the resistance in a conductor is not determined by its cross-section alone, but also by its length. (A long road is more difficult to traverse than a short one.)

In the case of electric currents there is also a third factor, namely the material of which the conductor is made. A current made to flow through a copper wire is not the same as a current flowing through an iron wire. Copper offers considerably less resistance to an electric current than iron. The illustration shows the metals copper, aluminium, zinc and iron arranged in the order of the resistance they offer to electric current. Copper heads the list with the lowest resistance, while iron comes last with the highest resistance.

Owing to their enormous resistance paper, glass, porcelain, rubber, wool, silk and certain lacquers will not allow an electric current to pass at all. These materials, therefore, are used as insulating materials with which electric wires are covered, i.e. "insulated", whenever this is considered desirable. Bare wires are suspended from porcelain "insulators".

Electric resistance is measured in "Ohms" and the symbol used for this unit of measurement is the Greek letter Ω , which is pronounced "Omega". High resistances are expressed in "kilohms", i.e. thousands of ohms (abbreviated k Ω) and very high resistances in "Megohms", i.e. in millions of ohms (abbreviated M Ω).

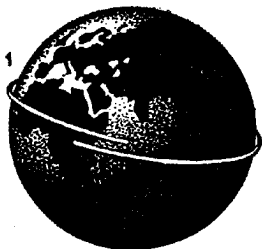

A copper wire of 1 sq. mm section around the world, gives a resistance of one megohm.

A copper wire with a length of 57 metres and a cross-section of 1 sq. mm has a resistance of 1 ohm. If such a wire were to be laid round the equator, its resistance would be a little less than 1 megohm. There is a very definite relationship between the three magnitudes tension, current density and resistance. This relationship may be expressed as follows:

The tension in volts divided by the resistance in ohms equals the current in amperes.

$$A = \frac{V}{R}$$

This is known as "Ohm's Law".

C: Alternating current



In the foregoing we have already come across “alternating current”, but we were unable to go into the matter closely. Here again we can only deal with part of this subject, but nevertheless we shall slowly but surely acquire the knowledge we need.

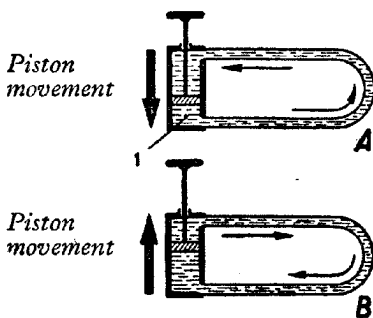

Piston movement down gives a current flow in direction A.
 Piston movement up gives a current flow in direction B.
 1 = water.

Alternating current constantly changes its direction, while direct current flows in one direction only. In this case, too, we can fall back on the comparison with flowing water. A direct water current, for example, flows through the pipe of the water supply. An alternating water current can be produced by moving a piston up and down in a cylinder. When the piston is set in motion an alternating water current is set up in the closed system of pipes communicating with the cylinder.

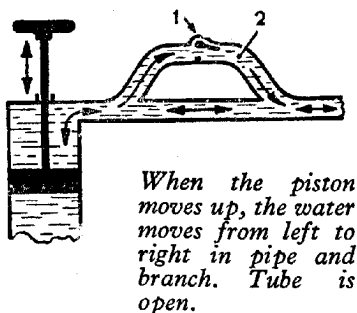

To achieve this a tube is required in the branch line, which opens only when the water comes from the left and closes when it comes from the right. Thus, the tube ensures that the water in the branch line can flow in only one direction: direct current.

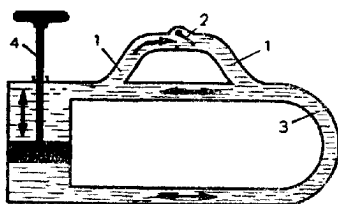

When the piston moves down the water comes from right to left, circulates freely in pipe (alternating current) but closes tube in branch and so ensures that the water can flow in one direction only: direct current.

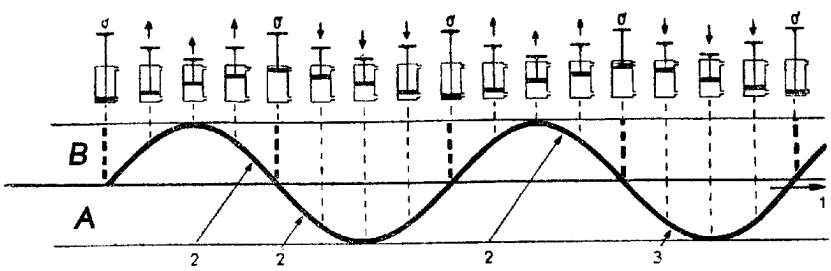

Graphical representation of A-B movement.
 1 = time. 2 = water flow in the communicating line. 3 = alternating water current.

The speed of the reciprocating movement of the piston determines the rate at which the current changes direction. If we plot the alternating water current in the form of a curve, we see the familiar picture of a wave train.

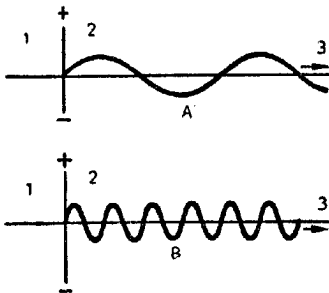

A = slow alternation, low frequency.
B = fast alternation, high frequency.
 1 = current. 2 = pressure.
 3 = time.

With a slow piston movement the waves of the curve will be longer (low frequency), while with a quick piston movement the peaks and the valleys of the waves will lie closer together (higher frequency).

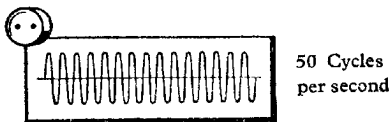

Graphical representation of alternating current from mains.

The electric alternating current of the mains supply shows 50 wave peaks and 50 wave valleys per second. Its frequency is therefore 50 c/s. This is a standard frequency used by most electricity supply companies. Mains supplies with a frequency of 60 c/s are encountered in North, Central and South America and in a number of other regions.

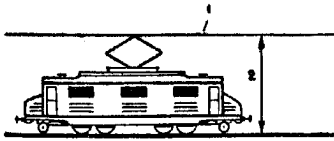

1 = overhead wire.
2 = alternating current of $16 \frac{1}{3}$ c/s.

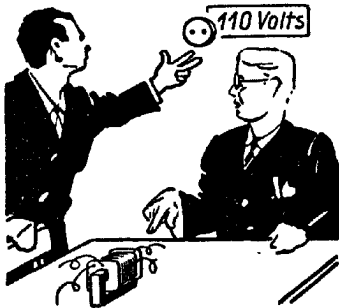

"But I want 220 volts!"
"Can be arranged with this transformer!"

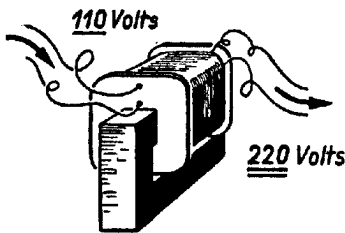

Transformer with iron core.

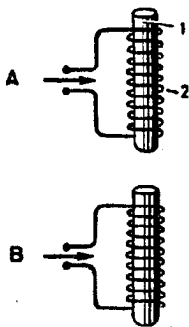

A = direct current. B = alternating current. 1 = iron core.
2 = winding.

An exception is the alternating current used for the operation of electric trains, which for certain reasons is often generated with a frequency of $16 \frac{1}{3}$ c/s.

Electric alternating current has a number of advantages over electric direct current. It can, for instance, easily be raised from a low tension to a high tension and vice versa. With direct current this can only be done by complicated means.

The changing of one voltage to another is effected by means of a voltage changer or "transformer". In its simplest form this piece of equipment consists of two separate windings placed round an iron core (soft iron).

Let us see what happens in voltage "transformation". When a current is passed through a number of turns of wire laid round an iron bar, this bar becomes magnetic, whether direct or alternating current is used.

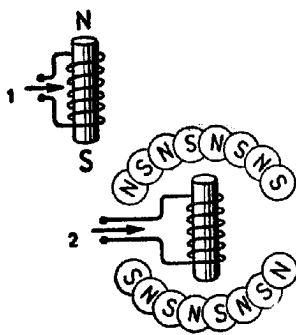

1 = direct current. 2 = alternating current.

There is, however, a marked difference. In the case of direct current a north pole occurs at one end of the bar and a south pole at the other. If the bar is magnetized by means of alternating current, there will be a constant change in polarity (corresponding to the frequency of the alternating current).

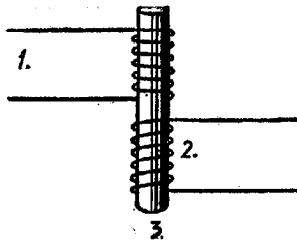

1 = first winding. 2 = second winding. 3 = iron bar.

If now we wind a second coil (quite separate from the first) on the iron bar, we can carry out a series of interesting experiments.

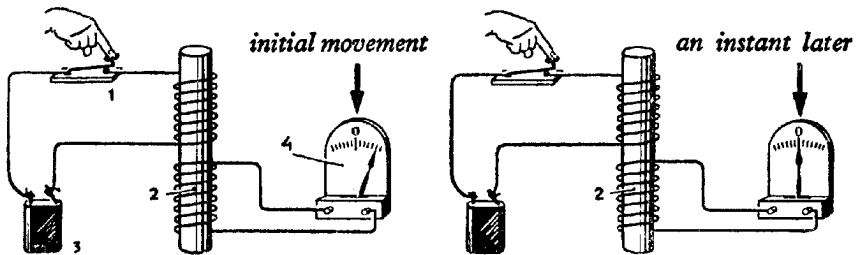

1 = key. 2 = iron bar. 3 = battery. 4 = measuring instrument.

We connect the ends of the second winding to a measuring instrument and pass direct current through the first winding by pressing a switch. The instrument will indicate a current surge by deflection of the pointer. However, the pointer will immediately return to its zero position, even when the switch is kept closed (zero point = vertical position of pointer).

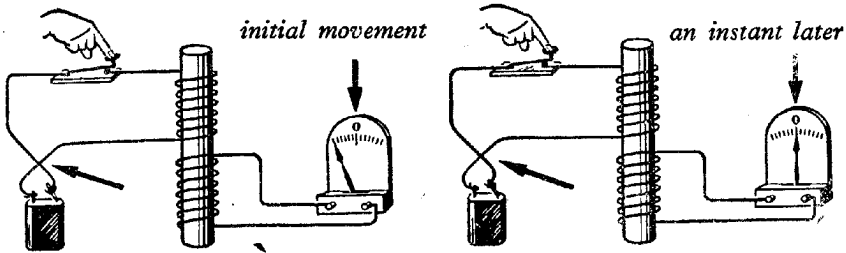

If we change over the wires on the battery, thus connecting the wire formerly on the positive pole to the negative pole and the other wire to the positive pole, the instrument will show a reading in the opposite direction when the key is pressed. In this case, too, the deflection of the pointer is very brief and, just as in the first experiment, the pointer immediately returns to its zero position when the switch is kept closed.

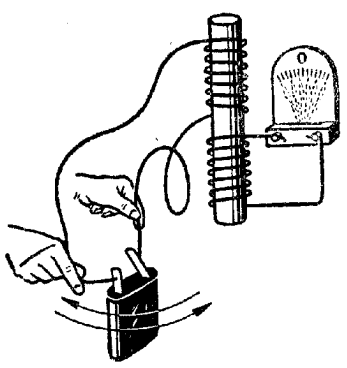

Continuous changing of connections.

The pointer of the instrument could of course be kept moving backward and forward by constant reversal of the wires on the battery. In this way we would cause a flow of current constantly changing in direction.

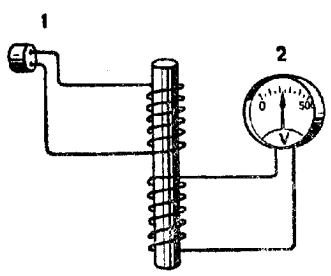

1 = alternating-current mains supply. 2 = alternating-current voltmeter indicates constant value.

This line of thought automatically suggests the idea of passing alternating current, instead of direct current, through the first winding. The pointer of the instrument connected to the second winding would then continuously move backward and forward, if . . . it were able to keep up with the rapid alternations of the current. The direct current measuring instrument, however, is much too slow. We should, therefore, use an instrument specially designed for measuring alternating currents or alternating voltages, which instrument indicates the currents or voltages by a steady deflection unaffected by the rapid current changes.

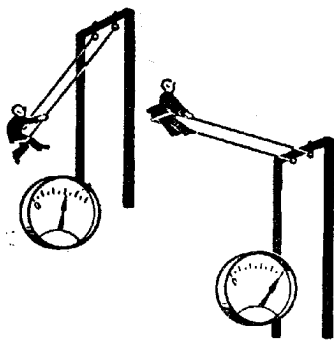

Such an (alternating-current) instrument might be compared to a device fitted to a swing, indicating that the swing is in operation and at the same time registering the amplitude of the swing's movement.

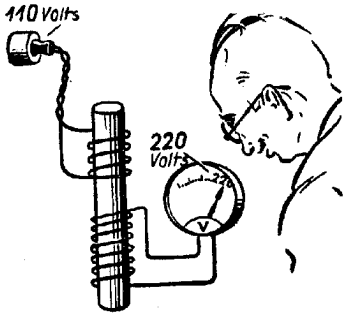

"That's funny!"

In any case, such an instrument is available for our experiments in the form of an alternating-current voltmeter, which in the illustration is shown connected to the second winding. If the first winding consists, for example, of 100 turns and the second winding of 200 turns, the voltmeter will - strangely enough - indicate 220 volts, despite the fact that the first winding is connected to a 110-volt alternating-current mains supply.

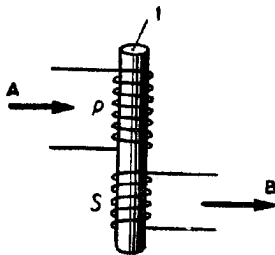

A = current in. B = current out
1 = iron bar.
P = primary winding.
S = secondary winding.

The electrician refers to the first winding through which the current is passed as the "primary winding" (P) and to the second as the "secondary winding" (S), while he speaks of the "primary side" and the "secondary side" of the transformer.

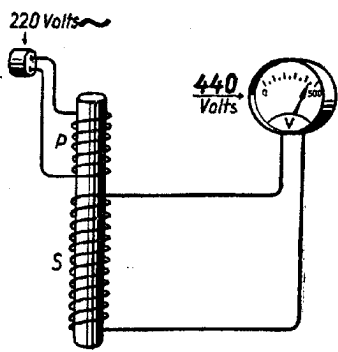

*Voltmeter indicates 440 volts.
P = 200 turns. S = 400 turns.*

We have seen that the voltage on the secondary side is twice as high if the secondary winding has twice as many turns as the primary winding. With 220 volts on the primary side this ratio of the windings will produce 440 volts on the secondary side; likewise, 50 volts on the primary side will result in 100 volts on the secondary side, and so on.

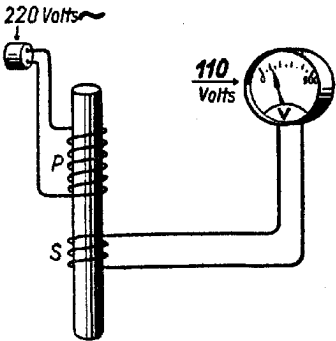

*Voltmeter indicates 110 volts.
P = 200 turns. S = 100 turns.*

We will now go a step further and wind a primary of 200 turns and a secondary of 100 turns on the iron bar. If we now connect the primary winding to a 220 volts alternating-current mains supply, the voltmeter connected to the terminals of the secondary winding will indicate 110 volts, or half the value of the supply voltage to which the transformer is connected.

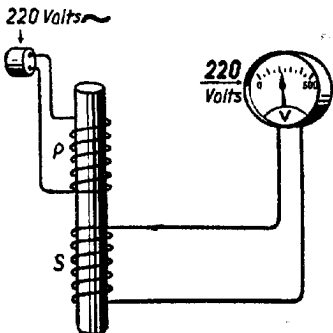

*Voltmeter indicates 220 volts.
P = 200 turns. S = 200 turns.*

With a primary of 200 turns and a secondary of 200 turns the secondary voltage will be just as high as that applied across the primary. In this case the "transformation ratio", as the electrician calls it, is 1 to 1. Dependent on the ratio of the numbers of turns, it can be 1 to 2 or 1 to 5 or 2 to 1 or 4 to 1, etc.

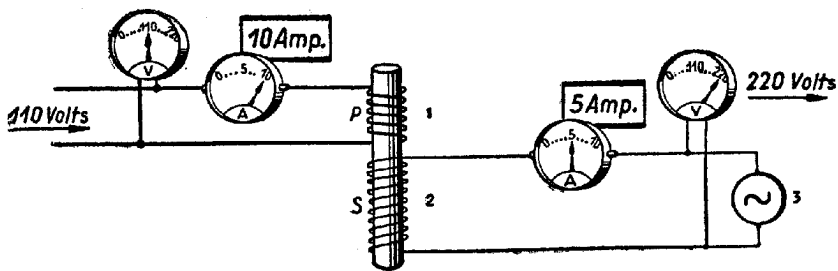

Primary of 1,100 watts (power) = Secondary of 1,100 watts (power).
 1 = 200 turns. 2 = 400 turns. 3 = load. A = ammeter. V = voltmeter.

Whereas we have so far concerned ourselves only with tension (voltage), we will now give some attention to the current density. In transformation the ratio of the current densities is inversely proportional to that of the tensions. If the transformer brings about an increase in tension, the current density will be reduced in accordance with the transformation ratio. With 110 volts and 10 amperes on the primary side, the corresponding values measured on the secondary side will be 220 volts and 5 amperes.

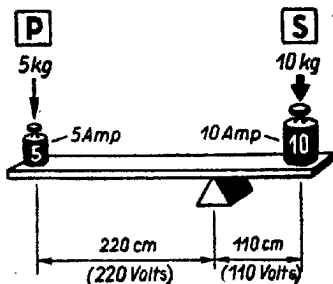
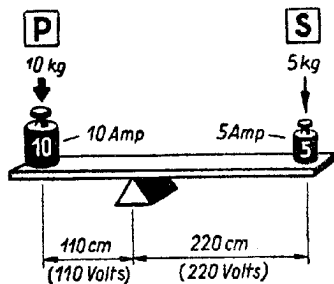

This may be illustrated mechanically with the aid of the lever principle. If one arm of the lever is twice as long as the other, equilibrium can only be achieved if the weight at P is twice that at S. The reverse is the case if the other arm is longer.

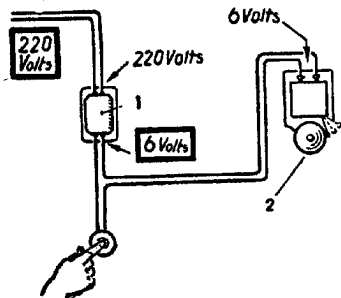

1 = low-power transformer.
 2 = electric bell.

Transformers are manufactured for a variety of purposes. The smaller types find numerous applications in radio engineering, which will be dealt with later. In many homes a bell transformer is used to reduce the high mains voltage of, say, 220 volts to the low voltage of 4 or 6 volts required (step-down transformer).

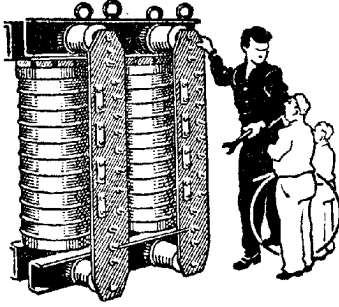

High-power transformer.

In electrical engineering giant transformers are employed for stepping high voltages up or down, e.g. from 3,000 volts to 30,000 volts and vice versa.

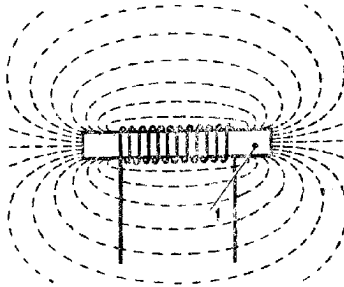

1 = open iron core.

Better electrical conditions than those obtained with the experimental transformers may be achieved by the use of a "closed" iron core. In the case of the "open" iron core the magnetic lines of force, which are very important in this connection, are wasted and lost in space.

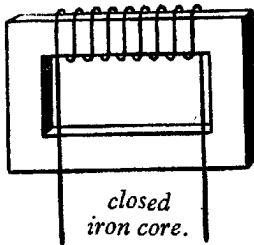

The "magnetic flux" is closed by constructing the iron core as shown, for example, in the illustration on the left.

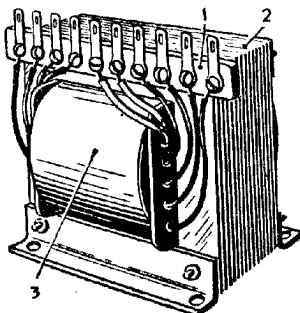

*Mains transformer for wireless set.
1 = terminal strip. 2 = iron core.
3 = coil.*

In effect this construction may take the form of the mains transformer for radio sets, shown here.

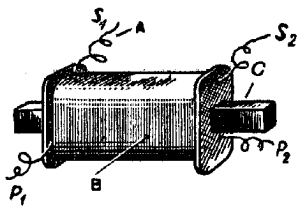

*A = connections. B = windings.
 C = iron core.
 P₁, P₂ = terminals of primary winding.
 S₁, S₂ = terminals of secondary winding.*

In practice the construction of a transformer is quite different from that shown in the experimental circuits. The windings are mounted on the iron core in the form of a carefully manufactured, well-insulated coil. The primary and secondary windings are usually wound one on top of the other. The terminals of the windings are brought out through the coil former.

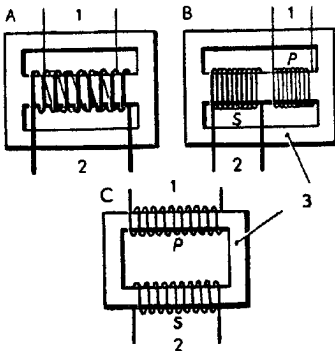

*1 = primary. 2 = secondary.
 3 = iron core.*

Primary and secondary windings can be wound over each other (A), or side by side (B) and also separately (C) on two legs of the core.

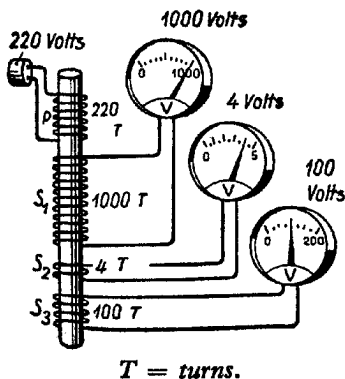

A transformer can be so designed as to furnish more than one voltage on the secondary side. To enable this a separate secondary winding is provided on the iron core for each voltage required (S₁, S₂ and S₃). Here again the ratio between the secondary voltages and the primary voltage is proportional to that of the numbers of turns of the windings.

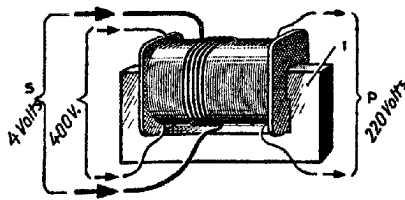

Transformer with three windings. 1 = iron core.

Transformers are employed in alternating-current radio sets. In these sets a number of different voltages are required. In view of the higher currents flowing in the low-tension circuits, a thicker wire is used for the corresponding windings of the transformer.

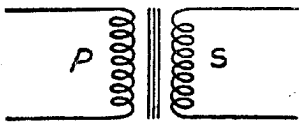

In circuit diagrams transformers are indicated by the symbol shown. The spiral lines represent the primary and the secondary windings, while the vertical lines between them represent the iron core.

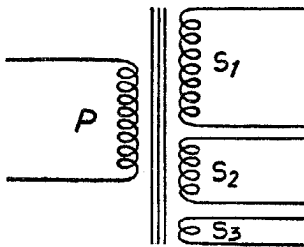

The symbol can, of course, be extended on the same lines if it is desired to represent a transformer with a number of secondary windings.

Graphical symbols for transformers.

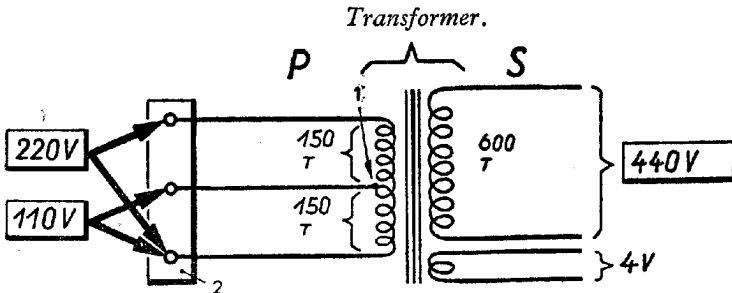

1 = centre tap. 2 = terminal strip.

In radio sets the primary of the mains transformer is connected directly to the mains supply. It must be so designed, therefore, that it can be connected to both 110-volt and 220-volt supplies. The

secondary voltages, however, must remain the same. This is achieved by tapping a 220-volt primary winding in the centre and bringing out the terminal. If half the winding is connected to a 110-volt mains supply, there will be no change in the secondary voltages. Let us assume that the 220-volt primary requires 300 turns. If one of the secondary windings is to furnish 440 volts, this winding should have 600 turns. Transformation ratio: 1 to 2. At 110 volts the transformation ratio should be 1 to 4 to produce 440 volts in the secondary winding; this would be the case with half the number of turns in the primary, viz. 150. Hence, the centre tap on the primary winding provides a simple solution to the problem.

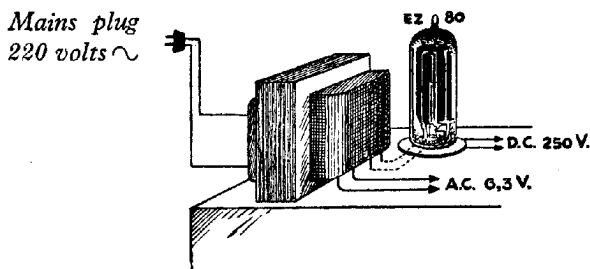

Supply part of a radio receiver consisting of a transformer and a rectifier tube (e.g. type EZ80). Symbols are used to indicate A.C. or D.C. This symbol ~ means A.C. and this = means D.C.

The various stages of the radio set require D.C. (Direct Current) voltages. The alternating current produced by the transformer must, therefore, first be converted into direct current by a rectifier. How this is done will be discussed in the next chapter.

D: Rectifying

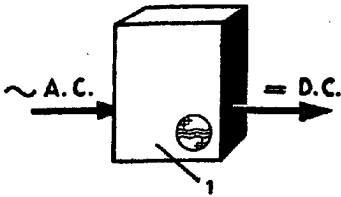

1 = rectifier.

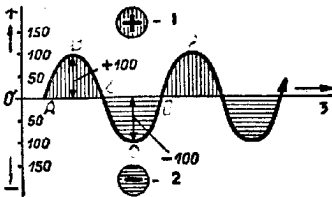

Alternating-current curve.

1 = + range. 2 = - range.
3 = time.

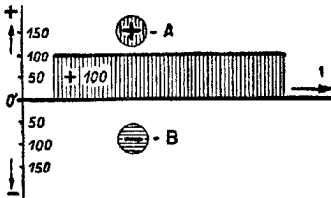

Direct-current "curve".

A = + range. B = - range.
1 = time.

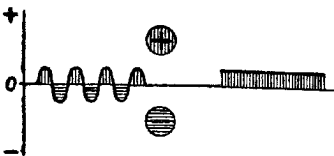

Rectifying from A.C. to D.C.

The object of a rectifier is to make direct current out of alternating current.

The alternating-current curve passes through the positive range one moment and through the negative range the next. The current moves backward and forward between plus and minus.

Direct current, on the other hand, remains in either the positive or the negative range and — since it does not change direction — its tension always retains the same value. Plotted in a graph its "curve" is, therefore, a straight line, which indicates that at a tension of 100 volts the current flows without changing its value.

The task of the rectifier is, therefore, ultimately to convert the alternating-current curve into a direct-current "curve".

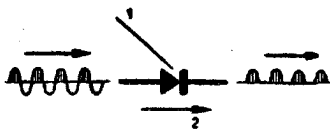

1 = electric tube. 2 = direction of current.

Various means are available. An electric tube can be inserted in the alternating current circuit. This tube only allows, for example, positive current components to pass. The graphical symbol of a rectifier is shown in the drawing. The arrow indicates the direction of flow.

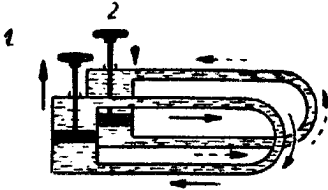

1 = up. 2 = down.

For the sake of comparison we must again revert to the water-current circuit with alternating direction of flow.

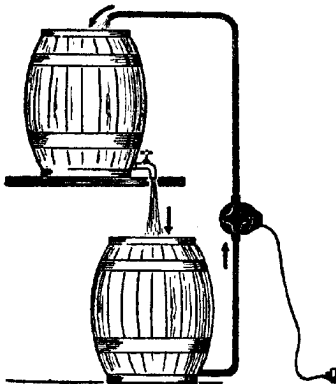

The main line communicates with a branch line through which direct current must flow.

This is an example of a direct current with water. Water is pumped from the lower barrel in the higher one, and flows through a tap from the upper into the lower barrel. The current flows in one direction only.

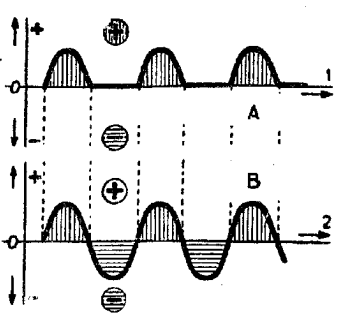

A = pulsating direct current.
 B = alternating current.
 1 & 2 = time.

If we were to plot the flow of current in the branch line in a curve, this curve would have the form shown in the drawing. The curve below represents the alternating water current in the main line.

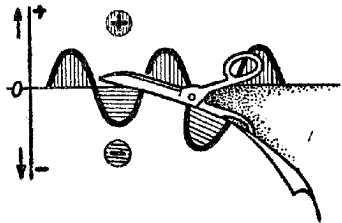

It will be seen that the part of the alternating-current curve below the zero line is no longer present in the direct-current curve. It has been "cut off".

Pulsating direct current



Flow of people →

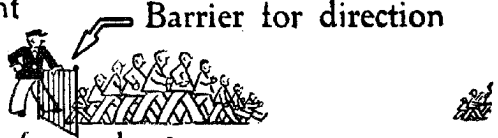

Barrier for direction

alternating current



first then reverses

It may be argued that the resulting direct current by no means follows a uniform course and that it is subject to strong fluctuations. Despite the fluctuations, however, the direction of the current remains the same. Such a direct current, which changes in value, is called a "pulsating" direct current. It may be compared with a flow of people which moves in one direction only, but in which the number of people changes constantly from high to low and vice versa.

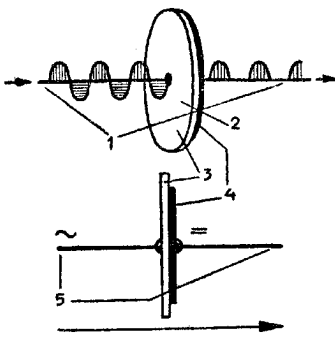

Metal rectifier.
 1 and 5 = connections.
 2 = rectifier element.
 3 = selenium. 4 = iron.

In electrical engineering alternating current is often converted into direct current by means of a so-called metal rectifier, e.g. the selenium rectifier. (Selenium is a chemical element with the properties of a metal.) This rectifier consists of an iron plate and a layer of selenium. The combination will permit electric current to pass in one direction only, namely in the direction selenium-iron.

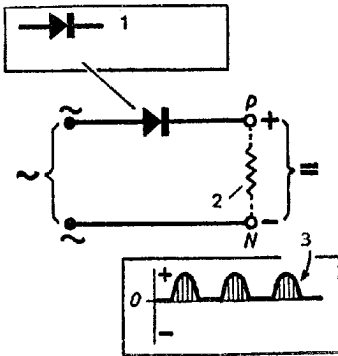

Half-wave rectification.
 1 = graphical symbol for a selenium rectifier.
 3 = pulsating direct current.

If this rectifier is inserted in an alternating-current circuit, a half-wave of the alternating current is suppressed. The result of the rectification is a pulsating direct current (curve shown in the lower part of the illustration).

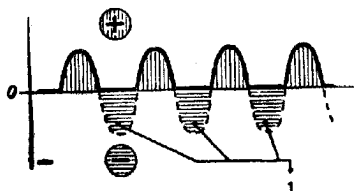

With half-wave rectification half of the current is lost!

In this process, which is called half-wave rectification, one half of the alternating current is lost.

It is possible in rectification to tip up the lower half of the direct-current curve, in which case the current is used to better effect.

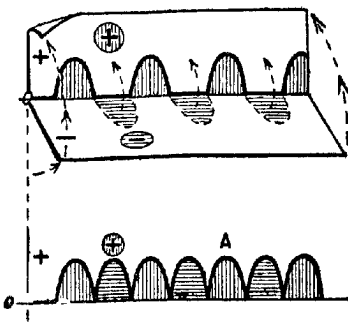

The negative range is folded over, so that it becomes positive.
A = result: full-wave rectification.

Half-wave rectification (mechanical).

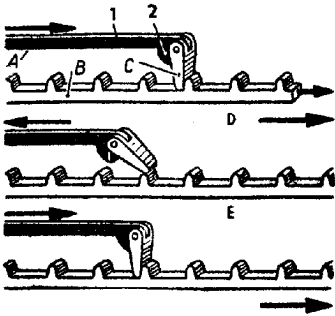

A = moving piston rod.
B = rack with fixed teeth.
C = cam.
D = pulsating movement.
E = no movement.
(always in the same direction).
1 = piston rod moving to the right.
2 = stop.

Mechanical comparisons will assist in explaining this "full-wave rectification". — Let us imagine a piston rod A which moves backward and forward. Attached to the front end of this rod is a cam C, which can lift to the right only. When the piston rod moves forward the cam C will press against one of the fixed teeth of the rack. As a result the rack is pushed to the right. When the piston rod moves backwards, the cam C lifts and is dragged over the next tooth. During the subsequent forward movement it pushes the rack further along. The reciprocating movement of the piston rod (alternating current) is thus translated into a jerking movement of the rack in one direction (pulsating direct current). This comparison illustrates half-wave rectification. One movement of the piston is ineffective.

*Full-wave rectification
(mechanical).*

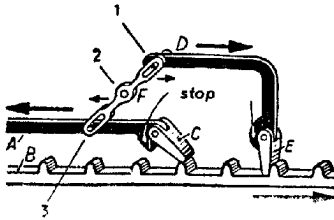

- A = piston rod moving left.*
- B = rack with fixed teeth.*
- C = cam.*
- D = piston rod moving right.*
- E = cam.*
- 1 and 3 = moving fulcrum.*
- 2 = fixed fulcrum.*
- 4 = direction of movement.*

If the mechanism is extended as shown in the illustration on the left, it will be possible to make effective use of both the forward and the backward movement of the piston rod A, resulting in a continuous forward movement of the rack. Thus, expressed in electrical terms, full-wave rectification is achieved. The operation of the mechanism is briefly as follows. As cam E pushes the rack forward, cam C moves backwards. As soon as the piston rod A moves forward again, cam C pushes the rack along and cam E moves backwards, whereupon the whole process is repeated.

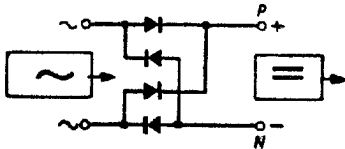

Full-wave rectifier.

The diagram shown represents the corresponding electrical circuit, involving four electric rectifiers.

First stage.

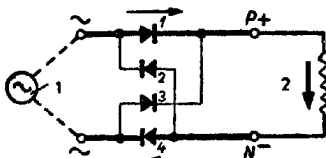

1 = current supply. 2 = load.

The flow of current in this circuit is as follows. When a positive wave of the alternating current arrives, it passes through tubes 1 and 4 in the direction indicated by the arrows. The current flows in one direction only (through the thick lines drawn in the diagram).

Second stage.

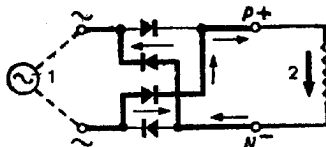

1 = supply. 2 = load.

Next, the negative half-wave of the alternating current comes along and the current flows in the direction of the arrows through tubes 2 and 3 (via the thick lines). Direct current is available across the terminals P and N, to which the current-consuming apparatus is connected.

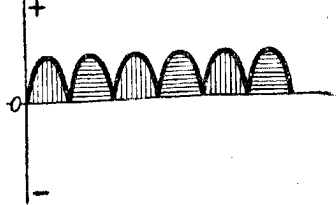

Pulsating direct current with full-wave rectification.

Full-wave rectification furnishes double the number of half-waves. The pulsation is, therefore, less intense.

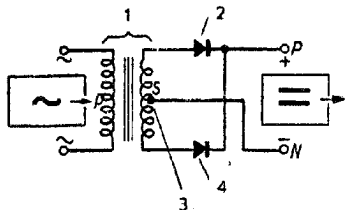

If a transformer is employed, two rectifiers will suffice, provided the secondary winding is tapped in the centre.

Full-wave rectification with two rectifiers.

1 = transformer. 2 = rectifier.
3 = centre tap. 4 = rectifier.

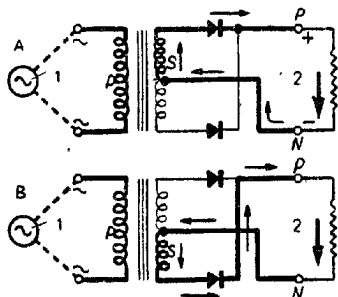

This illustration shows the flow of the current in two successive half-cycles.

1 = supply. 2 = load.
A = first half-cycle. B = second half-cycle.

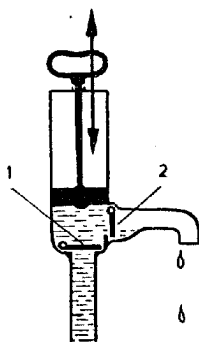

An important point is to suppress the pulsations which are still present. Here again we must fall back on a comparison with water, this time involving a pump.

1 and 2 are valves movable in one direction only.

When the piston in the pump barrel moves upward, valve 1 opens, water flows into the chamber and valve 2 remains closed.

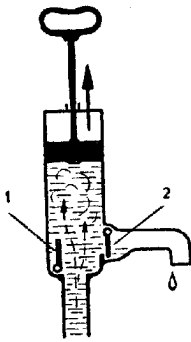

When the piston is pushed downwards, valve 1 closes, while valve 2 opens and water flows from the spout.

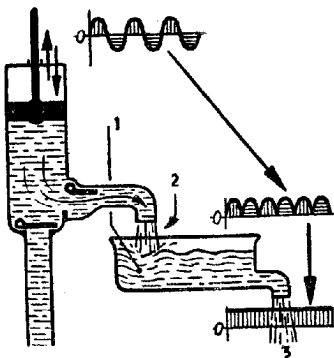
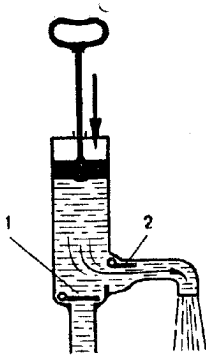

If the piston is continuously moved up and down, an interrupted stream of water will flow from the spout: pulsating direct water current. — A steady flow of water can be achieved, however, by the placing of a reservoir under the spout, so that the constantly interrupted stream of water is first collected. The water will then leave the reservoir in a steady flow.

1 = reservoir. 2 = pulsating flow. 3 = steady flow.
Look at the graphical representations.

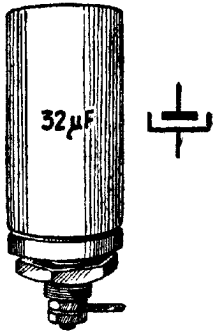
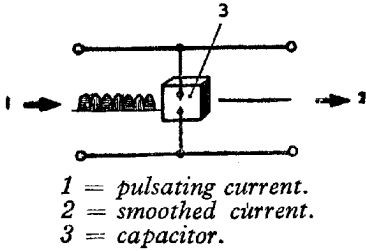

The capacitor in its practical form and as graphical symbol.

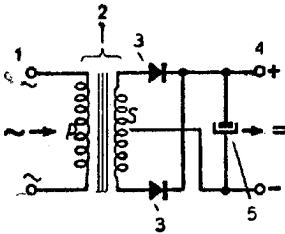

Circuit diagram of full-wave rectifier, with smoothing capacitor.

- 1 = input. 2 = transformer.
3 = tube. 4 = output.
5 = smoothing capacitor.

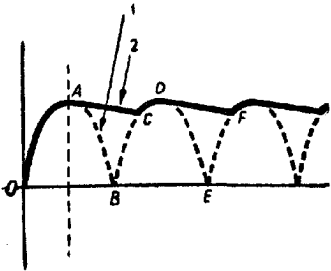

- 1 = pulsating direct current.
2 = smoothed direct current.

Translated into electrical terms, this means that we must use a "capacitor", which stores electricity during the current impulses and discharges the stored quantity of electricity during the current intervals.

The construction of such a capacitor will be discussed later. For the present it is sufficient to mention that in a circuit diagram a capacitor (or condenser) is shown as two parallel lines, or as the symbol indicated in the illustration.

Thus, a complete rectifier circuit may be drawn as shown in the illustration.

This full-wave rectifier circuit, complete with smoothing capacitor, furnishes an almost pure direct current. Starting at O, the curve of the pulsating direct current proceeds along A, B, C, D, E, F, etc. The capacitor which stores electricity is charged (filled) during the period between O and A. During the period between A and B the capacitor discharges current, so that the curve does not drop to B but gradually slopes down to C (discharging of capacitor). At that stage the fresh pulsation recharges the capacitor (C-D) and the same procedure is repeated.

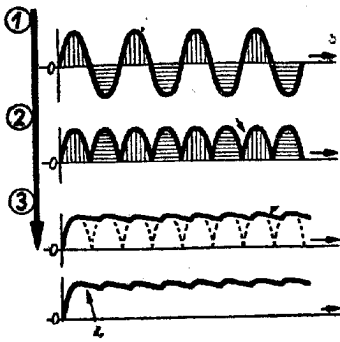

- 1 = alternating current.
- 2 = pulsating direct current.
- 3 = smoothed (pulsating) direct current curve.
- 4 = result (almost smooth).

The whole process in diagrams, starting with alternating current and ending with smoothed direct current, is represented here in a series of curves.

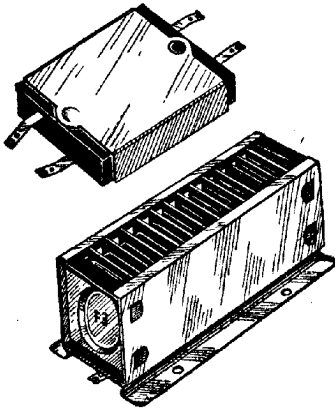

*Dry rectifier stacks,
round or square.*

In practice a number of metal rectifier units, dependent on the voltage, are connected in series to form small stacks. With higher current values two or more of such stacks can be connected in parallel, or else stacks of larger dimensions are used.



*Rectifier valve or tube, giving
full-wave rectification.*

In radio sets metal rectifiers are sometimes used instead of valve rectifiers. In the latter case the electric valves take the form of the familiar electronic valves or tubes.



There are rectifier tubes for both "half-wave" rectification and "full-wave" rectification. We will first deal with the half-wave rectifier tubes.

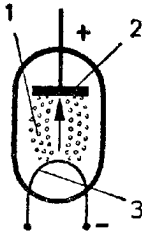

In a later chapter on electronic tubes it will be seen that in these the flow of current (flow of electrons) between the cathode and the anode is possible in one direction only.

1 = flow of electrons.
2 = anode. 3 = cathode.

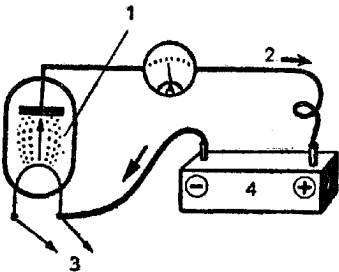

The current source which produces this flow, is (as explained on page 7) a "high-tension battery", of which the positive pole must be connected to the anode of the tube and the negative pole to the cathode.

1 = flow of electrons.
2 = anode current. 3 = h.t. battery. 4 = filament supply (battery).

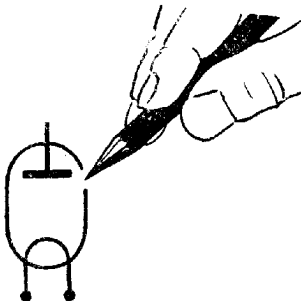

This is the graphical symbol of a simple (gridless) tube or diode.

Symbol for a half-wave rectifier tube (gridless tube).

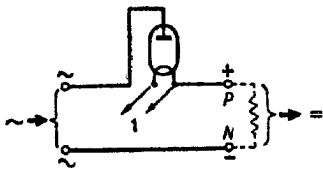

Electric tube = rectifier tube.
1 = to filament supply.

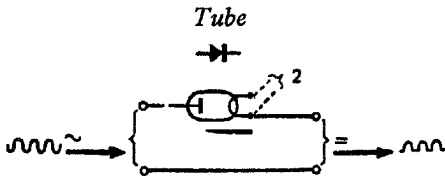

2 = to filament supply.

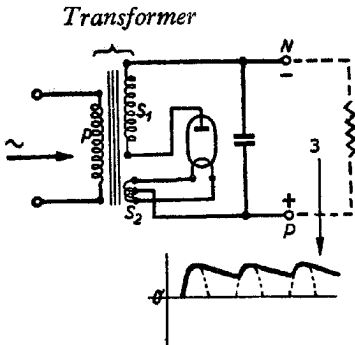

3 = diagram of "smoothed" direct current.

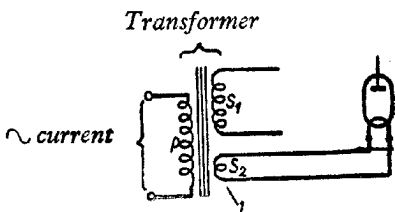

1 = filament winding (4 volts).

If we replace the high-tension battery, which supplies direct current, by an alternating current source likewise connected to the anode and to the cathode, the current flowing in the anode circuit, which may include a current-consuming appliance, will be pulsating direct current.

The explanation is simple. A flow of electrons, i.e. a flow of current, can only occur in the anode circuit when a positive half-wave arrives at the anode. During the negative half-wave no current flows in the anode circuit. This electronic tube, of which the filament will only emit electrons when it is hot, operates as a rectifier.

The strongly pulsating direct current obtained by this method of half-wave rectification is smoothed with the aid of a capacitor connected between N and P.

The tube filament need not be heated by means of a special battery. It can also be heated by alternating current. A low tension of, for example, 4 volts will suffice for this purpose. A transformer such as may be found in radio sets furnishes all the required voltages through its secondary windings, including the heating voltage.

Transformer

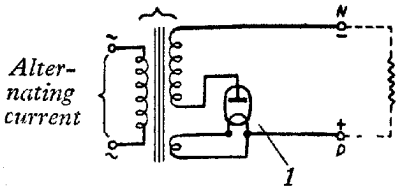

1 = rectifier tube with direct current.

The transformer serves mainly to supply the alternating current which is to be rectified. The voltage of this current can be raised to any desired value by means of transformation. Therefore, the rectified current which becomes available across the terminals N and P has a tension of the same value.

Transformer

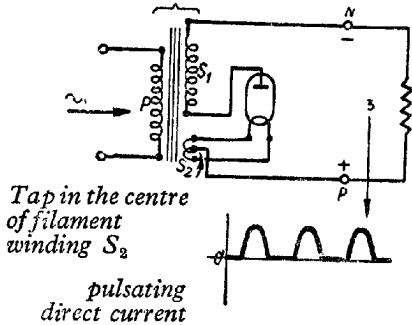

Tap in the centre of filament winding S_2

pulsating direct current

3 = the result is a pulsating direct current, as shown in diagram.

To ensure symmetrical conditions, the filament winding is tapped in the centre and this tap is connected to the positive pole P.

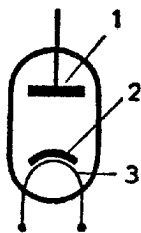

1 = anode. 2 = cathode
3 = filament.

The illustration on the left shows a diagrammatic representation of a rectifier tube. The type of tube shown has an "indirectly" heated cathode. Electrically the cathode is completely separated from the filament, i.e. the filament merely serves to heat the separate cathode, which emits the electrons. This type of rectifier tube may be found in A.C./D.C. sets. The tubes discussed so far, in which the filament at the same time serves as the cathode, are called "directly" heated tubes. Detailed information on this point will be furnished later.

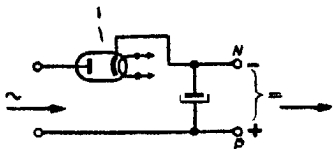

1 = tube.

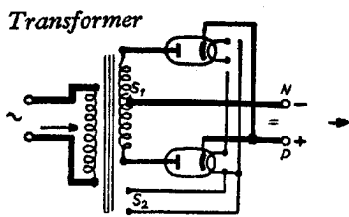

Full-wave rectification.

Two rectifier tubes can be used instead of one, in which case full-wave rectification is obtained.



Graphical symbol of an indirectly heated full-wave rectifier tube.

If the two anodes and the two cathodes are placed in a single glass envelope, i.e. in one tube, the result is a directly heated full-wave rectifier tube. The cathodes, in this case the filaments, of the two tubes are joined together.

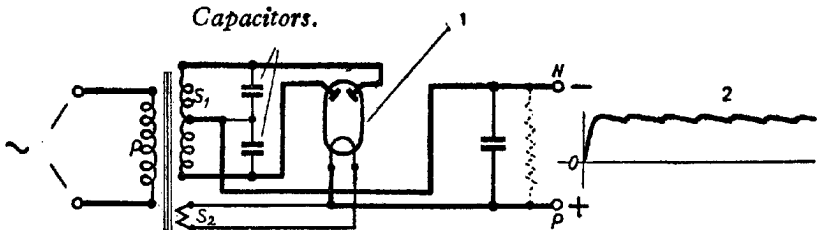

Full-wave rectification.

1 = full-wave rectifier tube. 2 = diagram of the result: smoothed direct current. The object of the capacitors will be explained later.

The above circuit diagram shows the full-wave rectification circuit complete with the required rectifier tube.

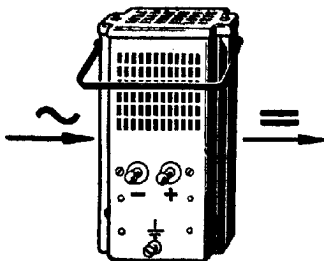

Tube rectifier for charging storage batteries.

More powerful rectifiers are manufactured for charging storage batteries.

CHAPTER TWO: RADIO ENGINEERING

A: Radio waves

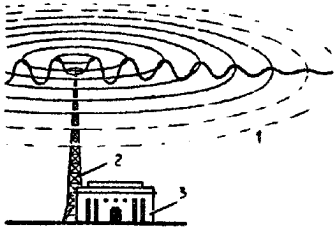

- 1 = transmitter waves.
- 2 = transmitting aerial.
- 3 = transmitter or wave factory.

Radio is a miracle of waves. Invisible waves carry music and speech inaudibly over great distances. If picked up at any point, the waves once more become sound. Radio engineers are capable of generating rapid electric oscillations in "transmitters" and, via high transmitting aerials, these oscillations are propagated through the aether.

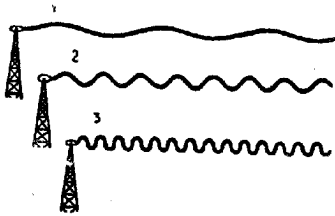

- 1 = long waves.
- 2 = medium waves.
- 3 = short waves.

The technical aids at their disposal enable them to radiate longer or shorter waves at will.

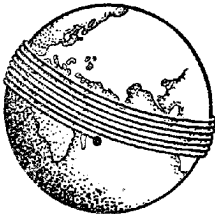

A radio wave travels 7 1/2 times round the world in one second.

The waves travel through the aether at an enormous speed, namely 300,000 kilometres per second. In one second they can travel 7½ times round the world!

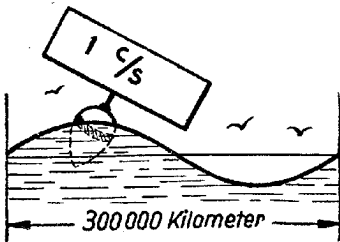

One wave per second.

An aether wave with a length of 300,000 km. makes only one complete oscillation per second (1 wavelength).

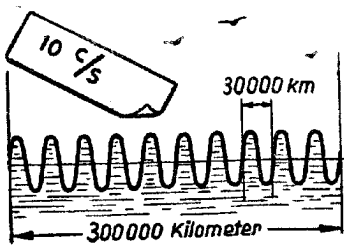

10 waves per second.

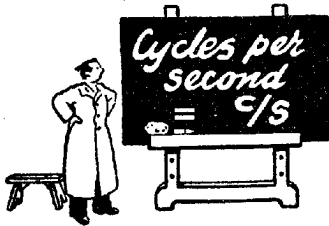

Waves per second = c/s.

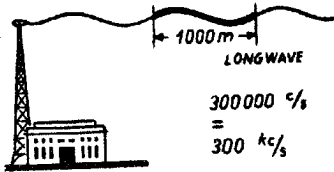

A wave not quite so long, let us say a wave of "only" 30,000 km, must, therefore, in the same time complete ten times as many oscillations and thus comprises 10 wave peaks and 10 wave valleys. (See page 49 for further details on waves.)

The number of oscillations per second is expressed in cycles per second (c/s). Thus, "10 c/s" represents ten oscillations per second.

The transmitters of the long-wave broadcasting stations radiate waves about 1,000 to 2,000 metres long. This is equivalent to 300,000 to 150,000 oscillations per second (or 300,000 to 150,000 cycles per second).

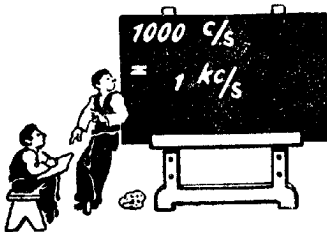

Easy to remember, just as 1,000 grams = 1 kilogram.

For the sake of simplicity 1,000 c/s may be expressed as 1 kilocycle per second just as 1,000 grams is referred to as 1 kilogram. (Cycles per second is abbreviated to "c/s" and kilocycles per second to "kc/s".)

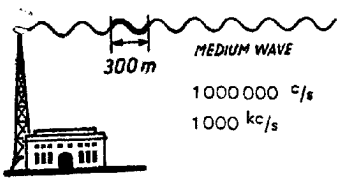

The medium-wave transmitters, those which occupy the greater part of our receiver dial and to which we tune in most, operate with waves of between 580 and 180 metres. A 300-metre wave completes one million oscillations per second (equivalent to 1,000 kilocycles per second).

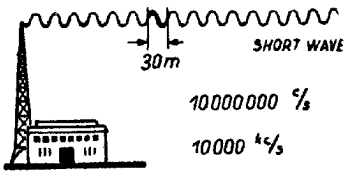



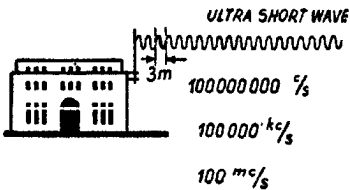









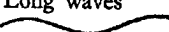
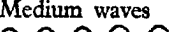
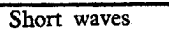
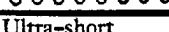
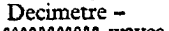

The short waves have even more "ups and downs". Their wavelength lies between 100 and 10 metres. A 30-metre wave completes ten million oscillations per second (10,000 kc/s).

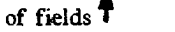

If we go farther still, we arrive in the range of the ultra short waves, viz. between 10 metres and 1 metre. The "very" short 3-metre wave oscillates 100 million times per second, producing as many peaks and valleys. Just by the way: 1 million cycles is equivalent to 1 megacycle (mega = 1 million); thus 100 million cycles per second is the same as 100 megacycles per second (abbreviated to 100 Mc/s).

Just to satisfy your curiosity it is pointed out that there are, of course, still shorter waves (more rapid oscillations) and it is possible to compile a complete "spectrum" starting with the longest and ending with the shortest waves.

This is called the "electromagnetic wave spectrum". Further on in this book reference is made to heat and light rays of which the wavelength is amazingly "short". Let us, therefore, study the "wave spectrum" as a whole.

Wave-length	Frequency in c/s	Types of waves and radiation		
10000 km	30	Low frequency	Alternating current, 60 or 50 cycles per second 	
1000 km	300		Speech and music waves of electric currents  Low-frequency electric waves 	
100 km	3000			
10 km	30 Thousand			
1 km	300 Thousand	Radio waves	Long waves 	
100 m	3 Million		Medium waves 	
10 m	30 Million		Short waves 	
1 m	300 Million		Ultra-short waves 	
10 cm	3 Milliard	High frequency	Field of latest research Overlapping of fields	
1 cm	30 Milliard			Decimetre - waves 
1 mm	300 Milliard			Centimetre - waves 
100 μ	3 Billion			Millimetre - waves 
100 μ	3 Billion	Light waves	Shortest possible electric waves 	
10 μ	30 Billion		Infra-red rays 	
1 μ	300 Billion			Infra-red radiation (Heat-rays)  Long distance photography 
1000 Å	3000 Billion		Ultra-violet rays	Visible light 
100 Å	30000 Billion	Heat therapy (Germicidal, Skin-tanning) 		
10 Å	300000 Billion	Gamma and X-rays	Overlapping of fields 	
1 Å	3 Trillion		X-rays 	
0.1 Å	30 Trillion		γ-Rays	Radio-active radiation 
0.01 Å	300 Trillion	Cosmic rays		Ultra-radiation 
0.1 X	30000 Trillion			
0.01 X	300000 Trillion			
0.001 X	3 Quadrillion			

The ultra-short waves (the metre waves) are followed by the decimetre waves, which in turn are followed by the centimetre and the millimetre waves. A little farther still we find the infra-red heat waves and then the light waves of still shorter wavelength. These are followed by wave ranges of extremely short wavelength, but their discussion would lead us too far. As regards the wavelength designations used in the table, it will suffice to say that μ (micron) is equivalent to 1/1,000 of a millimetre. Å stands for Angström and is equivalent to 1/10,000 of a micron. Finally, X is equivalent to a ten millionth part of a micron.

The number of waves per second, expressed in cycles, kilocycles or megacycles, is referred to by the radio engineer as "frequency". (Slow electric oscillations are referred to as "low-frequency" and the faster oscillations as "high-frequency".) As is clearly evident from the table, there is a very definite relationship between wavelength and frequency: the frequency, i.e. the number of oscillations per second, is higher according as the wavelength is shorter.

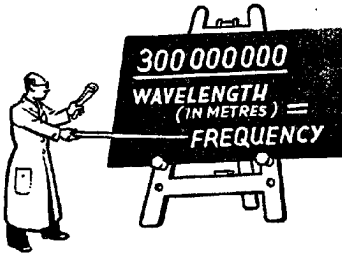

If the wavelength in metres is known, the frequency can be calculated with the aid of the formula shown in the illustration.

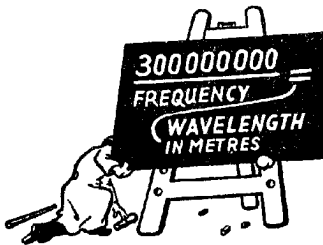

Conversely, the wavelength can be derived from the number of oscillations per second, i.e. from the frequency, in the same way.



There are various reasons why in radio we have not confined ourselves to the three "old" wave bands and why we have resorted to ever shorter wavelengths. The principal reason is that the original wave bands were much too crowded, so that the transmitters were causing mutual interference.

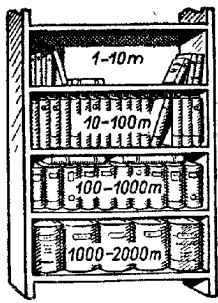

- 1-10 m Ultra- Short Wave band
(still space).*
- 10-100 m Short Wave band
(filled up).*
- 100-1,000 m Medium Wave band
(crowded).*
- 1,000-2,000 m Long Wave band
(filled up).*

a fourth shelf has been used, which is being filled with even thinner books (ultra-short waves or "VHF"). There is still room on this shelf.



This can be explained with the aid of another comparison. At first only long waves were used, which are represented by the fat volumes in the bookcase. The fat books (long waves) soon filled the limited space on the shelf. So that a larger number of books could be packed on the second shelf, the volumes had to be thinner (medium waves). Even then the available space was inadequate. The only solution was to take still thinner books — it should be pointed out that the contents of each book remain the same — which could be accommodated in greater number on the third shelf (short waves). For some time now

The scientific grounds for selecting shorter and shorter waves cannot be explained without some knowledge of the properties and characteristics of sound, which is carried along by the broadcasting waves. Special attention will, therefore, be given to sound waves in the next section.

B: Sound waves

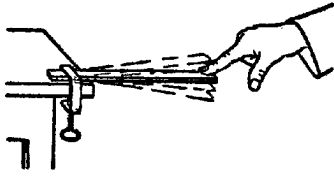

What are sound waves? They are simply movements of air, i.e. air waves. If a ruler is clamped down at one end and the other end is pressed and quickly released, its oscillating movement will be clearly visible.

The oscillations are transmitted to the air. The resulting air waves travel to the ear and create an impression of sound, which is the reason why they are called "sound waves".

Sound waves.

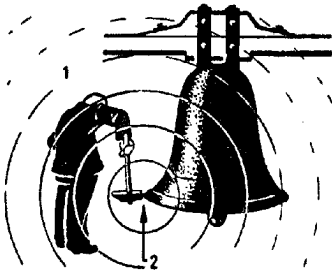

*1 = air or sound waves.
2 = source.*

A better note is obtained when a bell is struck. The metal of the bell starts to vibrate and the vibrations are transmitted to the surrounding air, thus resulting in sound waves. The source of the waves is the point at which the bell is struck by the hammer. From there the sound waves spread in a spherical pattern.

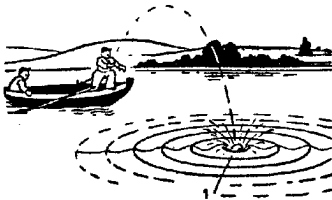

1 = source.

Sound waves can be compared with the waves formed when a stone is thrown into water.

"Not a sound to be heard!"

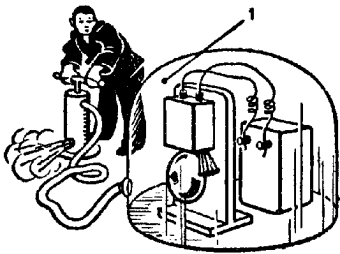

1 = vacuum.

It is quite easy to prove that sound waves are actually air waves. A loud electric bell placed under a glass cover can still be heard, although the sound will be somewhat muffled. If, however, the air is pumped out, not a sound will be heard. (Unlike sound waves, radio waves are not air waves; they do not require air for their propagation.)

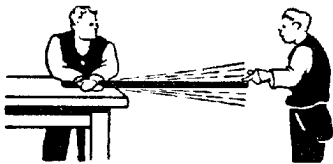

A low tone is heard

Rapid sound oscillations strike the ear as a high note and slow oscillations as a low note. This may be illustrated in an experiment with a vibrating rod. If the rod is long, the free end will oscillate relatively slowly when struck and slowly oscillating air or sound waves are produced. A low tone is heard

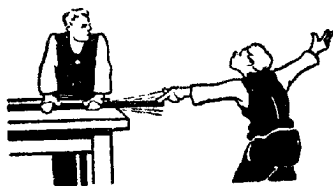

Now a high tone.

If the rod is short, it will transmit faster oscillations to the surrounding air, which produce rapid sound waves and thus a high tone.



1 = low tone. 2 = high tone.

It is possible to carry out the same experiment to better effect by passing the bow of a violin over a full-length string and then again over the same string when pressed down by the finger.

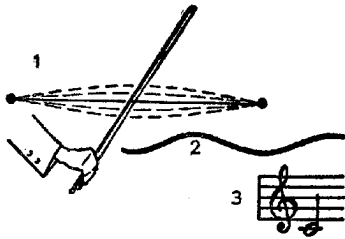

1 = long string. 2 = slow oscillation. 3 = resulting in a low tone.

The full-length string oscillates more slowly and the sound waves produced are long (small number of waves in a given period of time), resulting in a low tone.

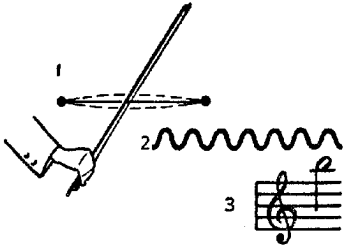

1 = short string. 2 = rapid oscillation. 3 = result is a high tone.

The shortened string oscillates more quickly and generates faster air oscillations, i.e. shorter sound waves (large number of waves in a given period of time), resulting in a higher tone.

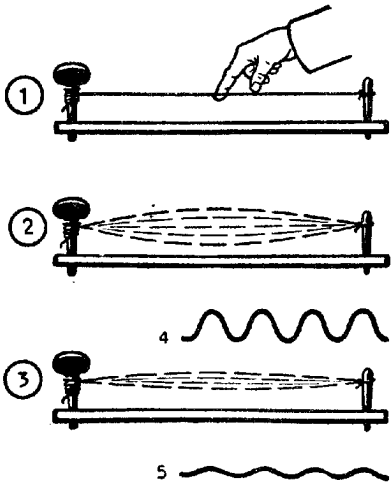

1 = tight string (violin) is plucked. 2 = strong oscillation gives a strong tone (4). 3 = weak oscillation causes a weak tone (5).

The amplitude of the oscillations is a measure for the resulting volume of sound: strong mechanical oscillations = strong air oscillations = strong sound waves = strong tone (Conversely: weak mechanical oscillations = weak air oscillations = weak sound waves = weak tone).



Sound can be generated in different ways, but in each case the air is caused to vibrate, irrespective of whether the instrument is a violin, a flute, an organ, a drum or a harp.

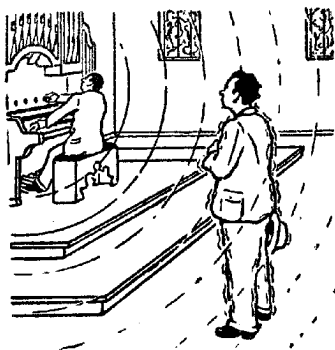

The lowest tone still audible to the human ear oscillates sixteen times per second (sixteen wave peaks with corresponding wave valleys). If they are strong enough, the sound waves of very deep tones can actually be perceived by means of the body itself, which is caused to vibrate in sympathy (for example, in the case of deep and strong organ tones).

$1 \text{ c/s} = 1 \text{ wave per second.}$

 2,000 times up and down.



"In one second?"

"Yes, that is 2,000 c/s!"

Engineers and physicists refer to the number of oscillations occurring in a given period of time as the "frequency". Just as in electrical engineering the unit of measure for the frequency is the "cycle per second" (abbreviated to c/s), "16 c/s", for example, denotes 16 oscillations per second. Likewise, 2,000 c/s is equivalent to 2,000 oscillations per second.

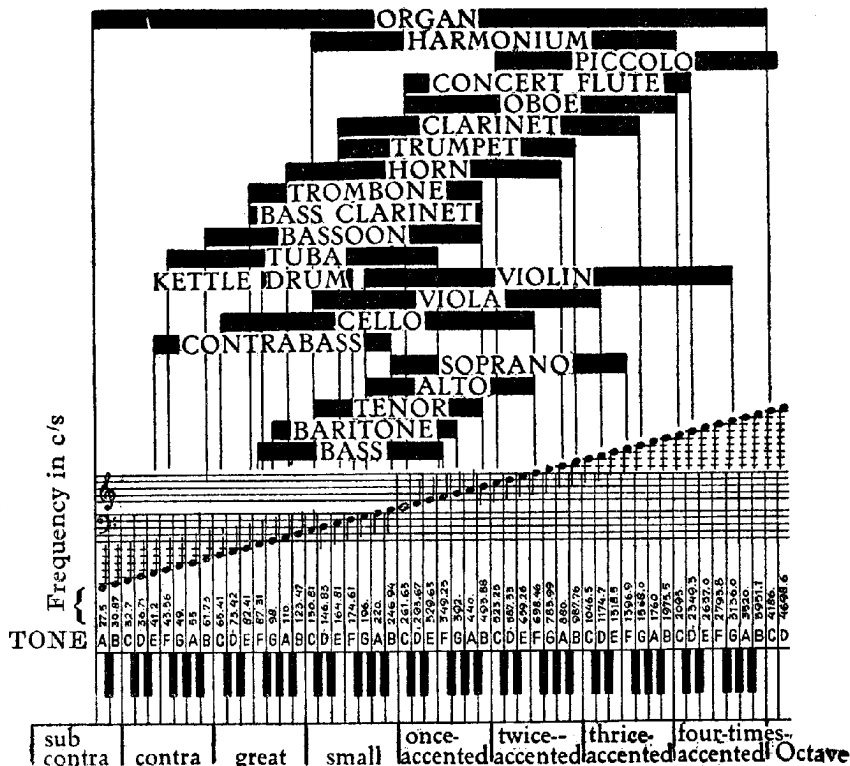

The highest tones still audible to the human ear have frequencies of from 14,000 to 16,000 c/s (different for each individual). There are, of course, still more rapid, but inaudible, sound oscillations. These are known as "Ultrasonic"!

Most musical instruments have a relatively small frequency range. The piano and the organ have the widest tone ranges. The highest tone (fundamental tone) of these instruments lies in the neighbourhood of 4,000 c/s (4,000 oscillations per second). Treble A has 440 c/s, contra C 32.7 c/s and the five-times-accented C 4186.03 c/s.

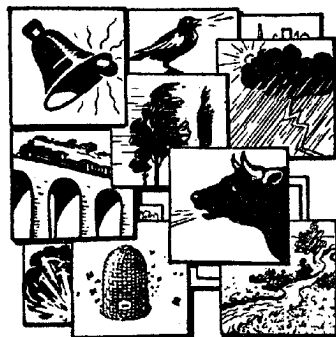

There are a great many types of sound, such as ringing, humming, squeaking, hissing, rushing, rattling, buzzing or banging, etc. Yet all these types of sound can be divided into three main categories: tones, composite tones and noise (unless we want to include the "bang").



Tone wave.

A tone is a pure sound wave with uniform wave peaks and wave valleys, such as have been represented in our illustrations as uniform wave trains.



1 = composite tone wave.

Compositetones, on the other hand, are composed of a number of tones, i.e. of a number of different sound waves.



1 = noise wave.

Noise is a combination of completely irregular air vibrations. A noise wave is a jumbled pattern of high and low, i.e. of long and short, sound waves.

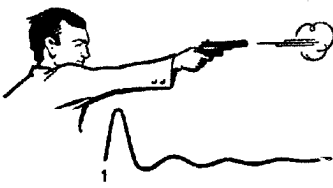

1 = curve of a bang.

A bang in fact amounts to a single but very strong air vibration. The sound curve of a bang resembles that shown in the illustration.

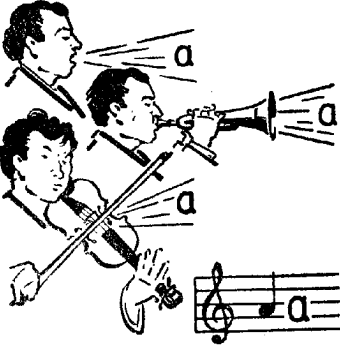

Three times the same note.

In acoustics and electro-acoustics we are chiefly concerned with tones and composite tones. In any case there are very few pure tones! Most of them are really composite. This is illustrated by the fact that one and the same tone will sound quite different if produced in different ways. Let us assume that the note A is sung, that the same note is played on a violin and that it is produced on a trumpet. Musically speaking, it is in all cases the same note A, which has its fixed place in the violin clef. Nevertheless, we can distinguish quite clearly between the different tones A produced by the voice, the violin and the trumpet.

Tone range of some instruments (incl. overtones).

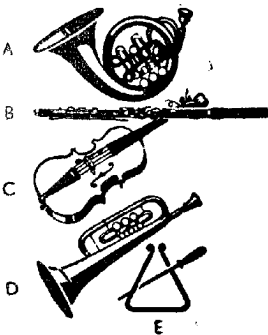

- a = french horn up to 1,500 c/s.
- b = large flute up to 4,000 c/s.
- c = violin up to 8,000 c/s.
- d = trumpet up to 9,000 c/s.
- e = triangle up to 16,000 c/s.

Each instrument produces "tones" with a specific "timbre". The fundamental tone is invariably mixed with other (higher) tones. These tones are called "overtones". The timbre of the instrument (or of the voice) differs as the nature and the number of the accompanying overtones vary.

The determining factor for the tone, however, is invariably the fundamental tone, which also has the greatest sound volume.

PHON-TABLE

Phon	Musical sign	Nature of the noise
0	—	Threshold of aural perception
20	ppp	Rustling of leaves with medium air movement
30	pp	Street noise in quiet district
40	p	Soft radio music
50	mf	Noise in a theatre before the performance (or street noise of average strength)
60	f	Loud speech
70	ff	A number of typewriters in a room (or loud street noise)
80	fff	Underground railway (or shouting)
100	—	Loudest noise of a motor bicycle
120	—	Aircraft at a distance of from 12 to 18 feet
130	—	Firing of a heavy gun (threshold of feeling; painful noise)

The unit of measure for the volume of sound is the “Phon”. The sound table given above commences with zero and ends with 130 phons. The word “phon” comes from the Greek and merely means “loud”. By “phonetics”, for example, is understood the “study of speech sounds”.



“You only hear the bang after three seconds.”

“Well, that means a distance of one kilometre!”

To recapitulate: Sound waves travel at a velocity of 333 metres per second. Light waves are considerably faster; they travel at a velocity of 300,000 kilometres per second. This explains why, in the case of a distant thunderstorm, we see the flash first and hear the thunder a little later.

C: Transmission and reception

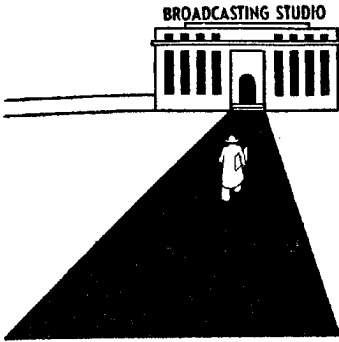

Now that we have learnt something about the nature of sound, we can pass on to some of the other processes which occur in radio (transmission and reception). But some patience is required, because we must not run before we can walk.

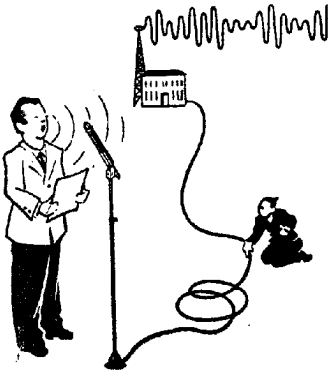

The (high-frequency) waves radiated by the transmitter carry the sound, which has been converted in the transmitting station to electrical waves (low-frequency), along on their backs. For this reason the long-range transmitter waves are called "carrier waves".



Let us take another illustrative comparison. Imagine the transmitter as a lawn sprinkler which sprays water in all directions, just as the transmitting aerial radiates electrical waves.

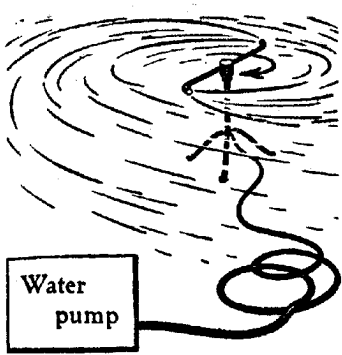

The water pump does to the water

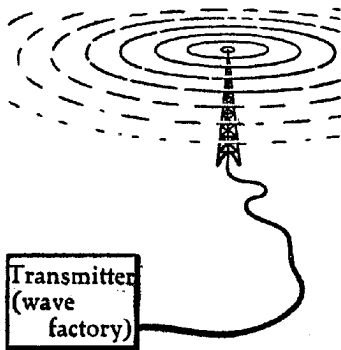

... what the transmitter does to the electrical waves: it pumps electrical waves into the aerial, from which they are radiated.

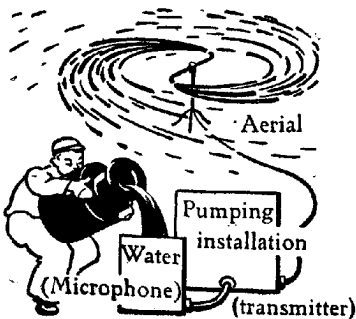

For some reason or other we do not want the lawn sprinkler to spray clear water but water with a blue colour, just as we do not want the transmitter to radiate purely electrical waves but waves coloured with music. We will, therefore, have to provide a special device which makes it possible to add blue colouring matter to the water to be sprayed.

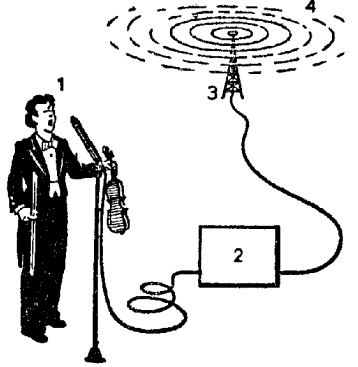

1 = speech and music. 2 = transmitter (pumping function).
 3 = aerial. 4 = same speech and music are transmitted.

In comparison the transmitter wave is a carrier of sound (in electrical form).

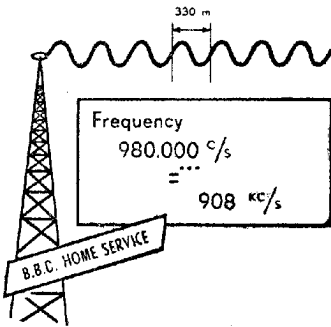

frequency: 908,000 cycles per second or 908 kc/s (kilocycles)
 B.B.C.

A normal transmitter wave has an accurately determined frequency, or, in other words, an accurately determined wavelength. The B.B.C. Home Service, for example, has a frequency of 908 kc/s (corresponding to a wavelength of 330 metres).

1 = unmodulated transmitter wave.

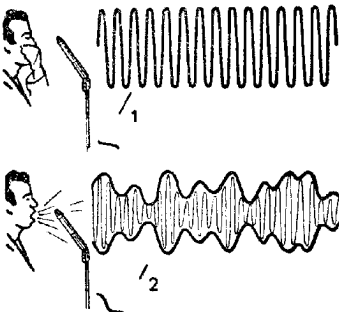

2 = modulated transmitter wave.

Radio engineers refer to a “modulated” wave when the transmitter wave carries sound and to an “unmodulated” wave when it does not carry sound.

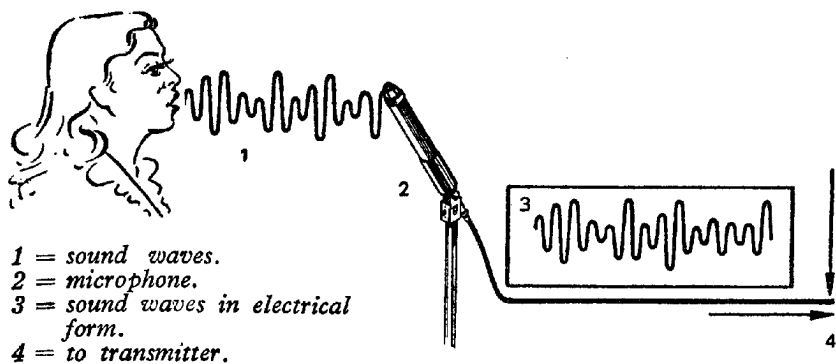

When the sound wave to be transmitted has the appearance shown in the picture

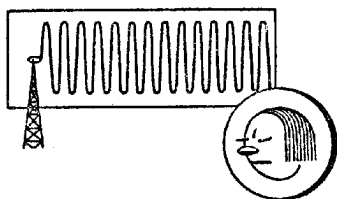

Unmodulated.

. . . and the unmodulated high-frequency transmitter wave looks like this

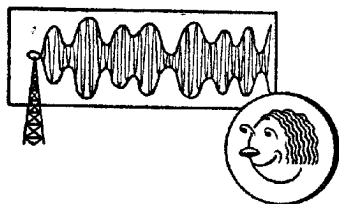

Modulated.

. . . . the modulated transmitter wave will take the form shown here.



Let us carry out a simple experiment with our broadcast receiver and tune in to the B.B.C. Home Service.

"Tuned exactly to the B.B.C. Home Service."

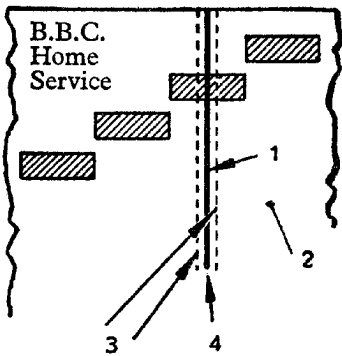

1 = dial indicator. 2 = part of the scale. 3 = badly tuned. 4 = correctly tuned.

If we move the pointer on the dial slightly away from the correct tuning position, either to the right or to the left, we can still hear the Home Service. The sound-carrying modulated wave cannot be confined to the frequency of 908 kc/s.

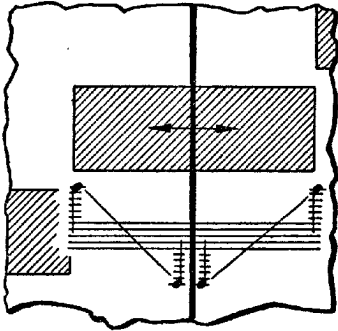

If the pointer is moved still further to the right or to the left, it will be clearly noticeable that the high tones are more pronounced, while the low tones more or less disappear.



Go on! We want a place too!

The load of sound waves on the "carrier wave" causes the original frequency to widen in both directions. The wider the audio frequency band (sound band) to be transmitted, the greater the space required by the transmitter on the dial of the receiver and the more inaccurate the tuning. Naturally, the other transmitters must also have enough room, so the individual transmitter should not take up too much space.



Equal rights (width) for all!

Each transmitter can, therefore, only be allotted a certain amount of space, so that interference between transmitters is avoided. (The radio engineer calls this "channel" width or "bandwidth".)

Audio frequency spectrum

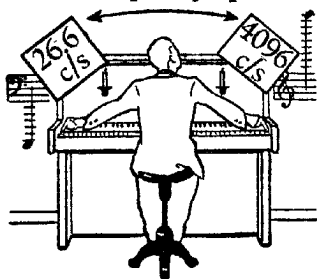

Reference has already been made to an "audio frequency band", by which was meant the band of audible sound waves ranging from the longest to the shortest sound waves. If it is desired, for instance, to transmit all the tones of a piano from the lowest to the highest, an audio frequency band will be required with a width of about 4,100 c/s (Lowest tone 26.6 c/s; highest tone 4,096 c/s).

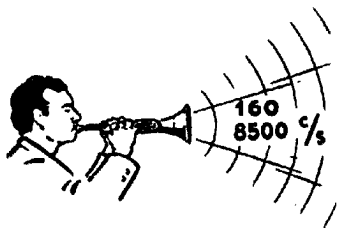

160 to 8,500 c/s.

If we include the overtones, which lend the instruments or the voice their characteristic nature or timbre, the audio frequency band will widen considerably on the side of the shorter waves (higher tones). In the case of a specific trumpet, for example, it will widen to 8,500 c/s.

B.B.C. Home Service
Correctly tuned in

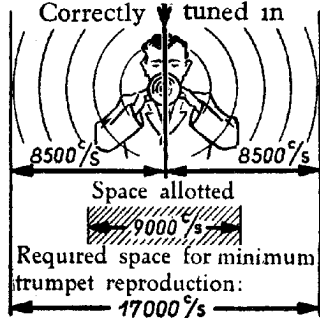

This simply means that a trumpet solo broadcast over the B.B.C. Home Service widens the actual frequency of the transmitter by 8,500 c/s on either side. The transmitter of the Home Service would then take up too much frequency space to which other broadcasting stations are entitled. It would cover part of the frequency space allotted to neighbouring stations and interfere with their broadcasts.

Channels of individual transmitters

9kc/s 9kc/s 9kc/s 9kc/s 9kc/s 9kc/s



Frequency distance between transmitters: 9kc/s.

If it is desired to accommodate a large number of transmitters in a wave band, this can only be done by restricting the channel within which they may operate. In practice the channel width allotted in Europe to each station is only 9 kc/s (elsewhere 10 kc/s) which corresponds to an audio frequency band of 4,500 c/s on either side of the transmitting frequency.

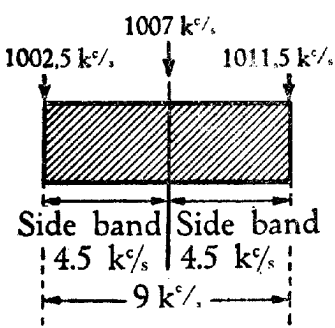

The transmitter of the BBC Home Service has a transmitting frequency of 908,000 c/s and is therefore entitled to expand on the one side to 912,500 c/s ($908,000 + 4,500 \text{ c/s}$) and on the other to 903,500 c/s ($908,000 - 4,500 \text{ c/s}$).

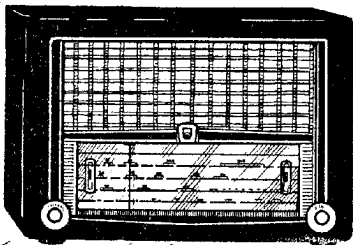



BBC

This restriction of channel width is effected at the expense of the tone quality, but in view of the crowding of the transmitters, especially on the medium-wave band, there was no other choice. Unfortunately, the European countries have not strictly observed the agreements made in this respect. New stations have crept in everywhere, the result being wavelength chaos, so that even with the

best of receivers there are very few broadcasting stations which can be received without interference from neighbouring stations. For this reason schemes have been devised for the allocation of wavelengths, but irrespective of whether scheme A or scheme B is adopted the fact remains that the transmitters must be spaced at intervals of 9 kc/s . For example, in the medium-wave band between 180 metres and 600 metres, i.e. between 1,670 and 500 kc/s, it is possible to accommodate some 130 transmitters with a channel width of 9 kc/s , each within the available range of 1,170 kc/s, and no more. At present, however, the number of stations operating in this band is about 400 (in Europe); hence the considerable interference between transmitters.

Number of transmitters
that can be accommodated

Type of wave:	↓
 Long wave (2000 to 1000 m)	16
 Medium wave (600 to 180 m)	130
 Short wave (50 to 10 m)	2400

The number of stations that can be accommodated in the long-wave band, which for practical purposes can be assumed to range from 1,000 to 2,000 m, i.e. from 300 to 150 kc/s, is even smaller. The total width of the band is only 150 kc/s, so that only sixteen transmitters with a channel width of 9 kc/s each can be accommodated. The short-wave band on the other hand offers much more scope. If we take that part of the band which lies between 10 and 50 metres, i.e. between 30,000 kc/s and 6,000 kc/s, it will be seen that here alone there is sufficient space for 2,400 short-wave transmitters with an increased channel width of 10 kc/s.

Practically all broadcast transmitters employ amplitude modulation (A.M.). The transmitter radiates waves of a specific frequency and these waves are "modulated" with the speech or music to be transmitted. This means that the amplitude of the H.F. (high frequency) oscillations is made smaller or greater in accordance with the rhythm of the speech or music. In the receiver the extremely weak signals are first amplified, whereupon the sound waves are removed from the amplified signal by means of detection. The sound waves are then amplified and passed to the loudspeaker.

D: Broadcast receivers & fundamentals



The broadcast transmitting waves, some stronger than others, carrying with them the sound waves which have been converted into electrical form, travel criss-cross through space. An apparently inextricable chaos.

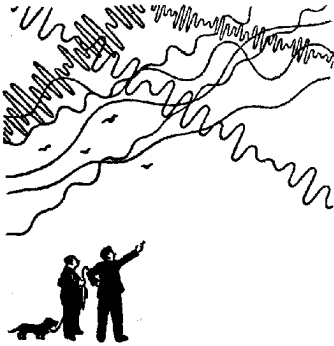

The "tuning elements" of our broadcast receiver are capable of selecting from this chaos of waves, picked up by the aerial, the particular wave we wish to receive. It will soon be clear how this is done.

"That's the wave I want!"

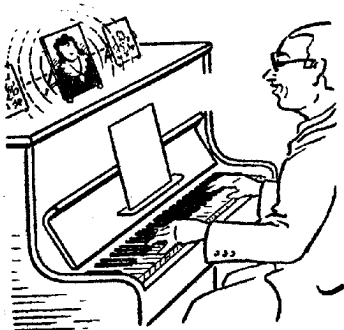

"Funny!"

The effects of resonance will be familiar to all, even though the physical phenomenon involved is not always fully realized. The secret of wireless reception is based entirely on "resonance" and we shall, therefore, study this phenomenon more closely. Someone is playing the piano. On top of the piano there are a number of framed photographs. These photographs will start to vibrate when certain keys are struck, but each of them will respond only to the note of a specific key. This is an example of resonance.

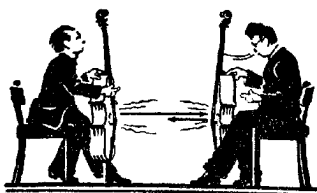

Transmitter. Receiver.

Both instruments are tuned to the same sound wave.

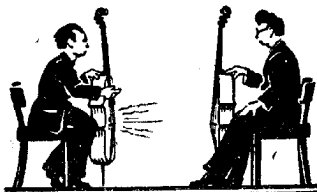

Transmitter. Receiver.

The two cellos are not tuned in.

When two cello players sit facing each other and one of them plucks a string on his instrument, the corresponding string on the other instrument will also start to vibrate and emit a tone! This will only occur, however, if the two strings are "tuned" to the same tone.

The second instrument will remain silent if the frequency of the string concerned does not correspond exactly to that of the string plucked on the first instrument, i.e. if the strings are not "tuned in" to each other.

The nature of this remarkable phenomenon can be easily explained with the aid of another simple experiment. Let us assume that a boy wishes to impart a strong swinging motion to a heavy iron ball suspended from a wire.

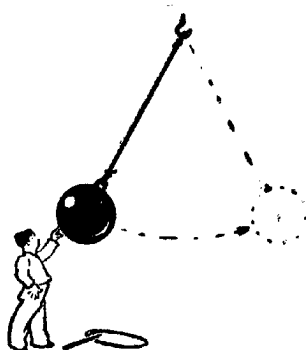
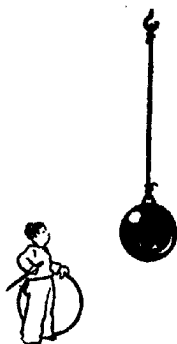

With very little effort the boy can move the ball into a swinging motion. All he has to do is push it gently at correct intervals, when it will start to swing higher and higher.

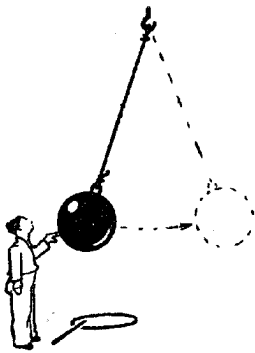

With this pendulum: one push per second.

Once the ball is swinging it is easy to time the next push, which must always occur the moment the ball changes its direction of movement. Let us assume that the time elapsing between the individual pushes is one second.

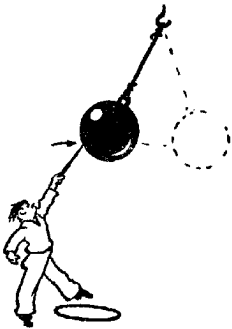

With this (shorter) pendulum: one push every half second.

If in a further experiment the boy attempts to achieve the same result by timing the pushes at half-second intervals, his effort will be in vain, since the frequency of the pushes must be fully in agreement with the characteristics of the oscillatory mechanism!

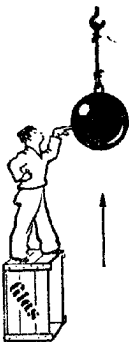

With one push per second the ball remains stationary.

A short pendulum requires a fast rhythm of pushes.

If the boy were to shorten the pendulum and push the ball at the same rate as before, he would again fail to achieve his object, since in that case he would have to push the ball at much shorter intervals.

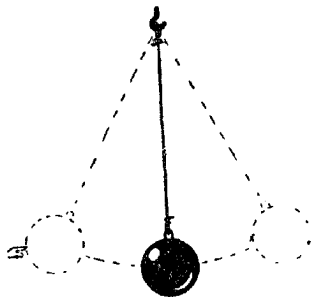

A long pendulum requires slow rhythm of pushes.

In the case of a pendulum longer than the first one the pushes must be repeated at longer intervals. The frequency of the pushes must invariably correspond to the "fundamental frequency" of the pendulum, i.e. they must be in resonance. Anyone who has ever been on a swing will not find this difficult to understand.

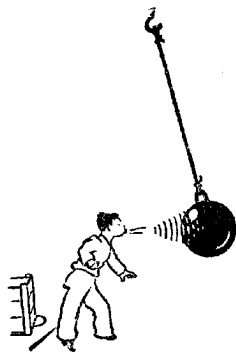

Corresponding conditions.

Providing he observes the correct time intervals, the boy can even set and keep the pendulum in motion by means of rhythmic blowing.

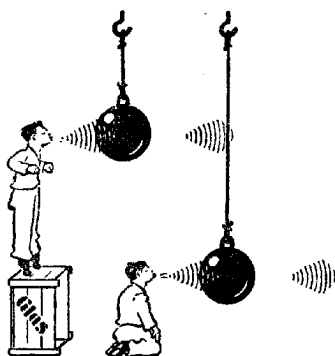

Conditions do not correspond.

This is only possible, however, when the conditions are exactly right, i.e. when the intervals between the puffs of air are in agreement with the specific characteristics of either the short or the long pendulum. Thus, the rhythm of the puffs must be varied according as the pendulum is longer or shorter.

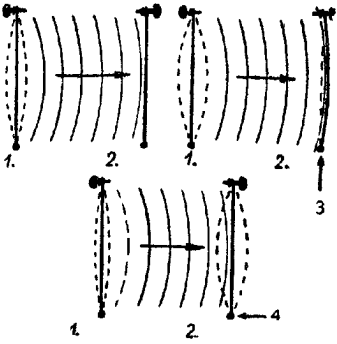

- 1 = string made to vibrate.
- 2 = air waves.
- 3 = other string starts to oscillate.
- 4 = string oscillates strongly and emits an audible note.

The same principle applies in the case of the cello strings. When the first string is plucked its vibrations are transmitted to the surrounding air and the air waves strike the corresponding string on the second instrument in the form of sound waves. At first the resulting vibrations of the second string are very weak, but they are quickly amplified by the successive rhythmic air waves. Finally, they become so strong that the string starts to emit a clearly audible note. Thus, resonance is achieved. (No resonance is attained if the strings

are not properly tuned in to each other, if one is longer or shorter than the other, or tightened to a different degree!)

Faster oscillations.

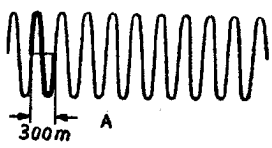

Frequency: 1,000 kc/s. Wavelength: 300 m.

Slower oscillations.

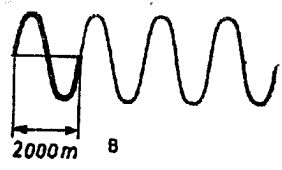

Frequency: 150 kc/s. Wavelength: 2,000 m.

The broadcast transmitters radiate aether waves, hence electrical waves. Depending on their "frequency", they are longer or shorter. They are measured in metres.

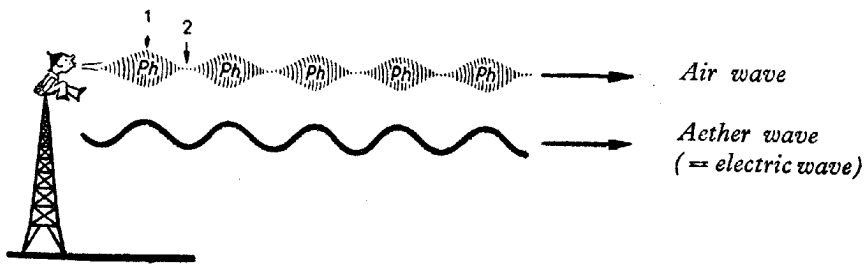

1 = strongest point. 2 = weakest point.

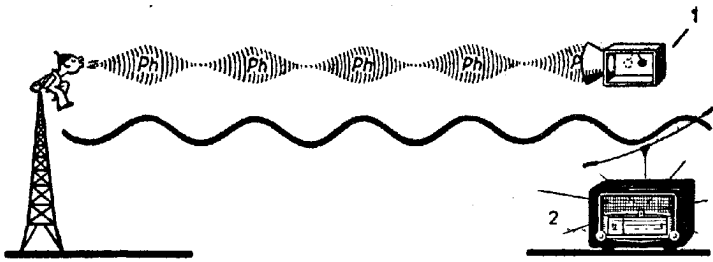

1 = receiver for air waves. 2 = radio receiver.

At the receiving end we need a receiver consisting of a pendulum which is to be made to oscillate. If the characteristics of this pendulum correspond to the frequency of the breath waves, it will start to swing to and fro.

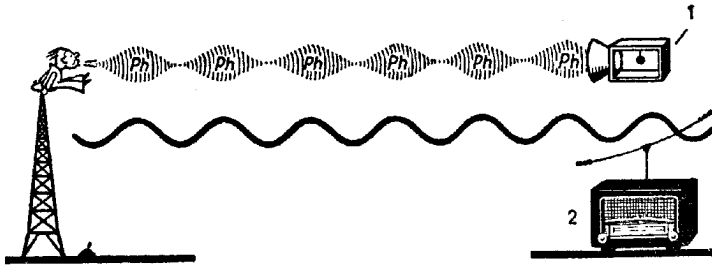

1 = breath receiver. 2 = radio receiver.

If, for example, the rhythm of the breath waves is faster (higher frequency), the (same) pendulum will remain motionless.

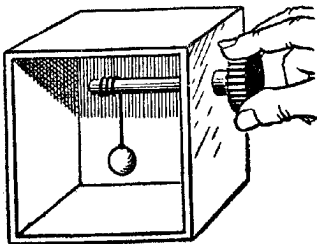

To enable the breath wave receiver to be "tuned" to any wave frequency, it should be fitted with an adjusting device, whereby the length of the pendulum can be altered at will.

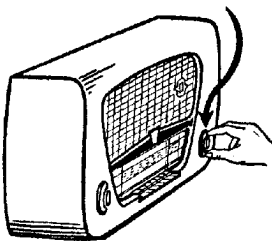

When we turn the tuning control of a broadcast receiver, we simply "tune" the set to different transmitter wavelengths (= to different frequencies).

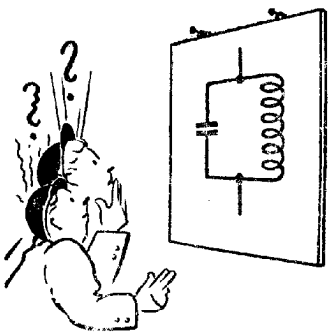

Oscillatory circuit.

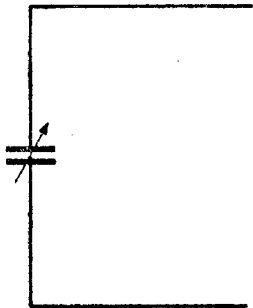

Symbol for variable capacitor.

A little farther back we referred to an electrical "oscillatory" device. This is, of course, quite different from the mechanical pendulum. The oscillations which occur in this device are just as invisible as the incoming waves. It comprises a "capacitor" and a "coil", which together constitute an oscillator circuit.

The nature of a capacitor has already been explained in the section on "rectifiers", when the graphical symbol was also shown. The capacitor discussed there, however, was of the fixed type, which means that its capacity (to hold electricity) cannot be changed. For "tuning" purposes, on the other hand, we require capacitors of which the capacitance can be readily and uniformly altered. Such capacitors are available in the form of "variable capacitors". The graphical symbol resembles that of a fixed capacitor, but the arrow indicates that it is of the variable type.

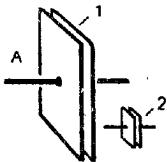

*1 = large capacitor having large capacity for holding electricity.
2 = small capacitor having small capacity for holding electricity.*

A capacitor has a specific capacitance, which is directly proportional to the area of the plates opposite to each other. The greater this area, the greater the capacitance of the capacitor.



Likewise: 1 = large and 2 = small capacity for holding liquids.

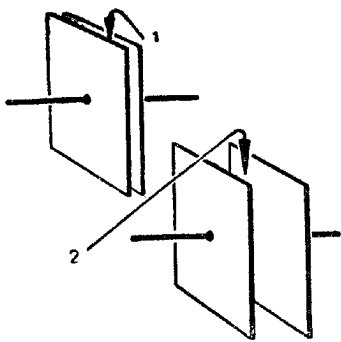

1 = small plate distance having large capacitance. 2 = large plate distance having small capacitance.

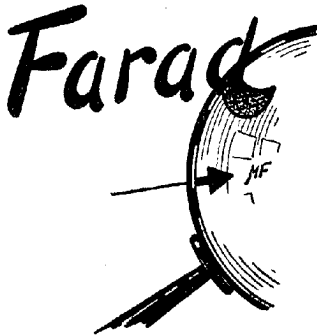

Farad = unit of measurement for capacitance. In practice the microfarad (μF) is used.

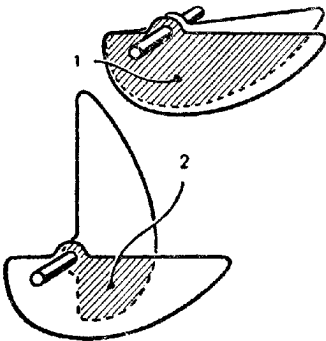

1 = relatively large capacitance. 2 = relatively small capacitance.

The capacitance is furthermore determined by the distance between the plates and it is greater according as the distance is smaller. The type of insulation between the plates also plays a part, since the capacitance with air, for example, is different from that with glass or paper.

Physicists and engineers employ a special unit of measurement to denote the capacitance of a capacitor, viz. the "Farad", named after the British physicist Faraday. As the value of the farad is much too large for practical purposes, capacitances are usually expressed in microfarad (abbr. μF), which is a millionth part of a farad. In radio engineering capacitors of much smaller capacitance are employed, so that a further subdivision had to be made, viz. the "picofarad" (abbr. pF or $\mu\mu F$). This is a millionth part of a microfarad and a billionth part of the farad!

In the case of the variable capacitor the capacitance is adjusted by the turning of one stack of plates out of another. (The two stacks of plates are insulated from each other by air.) Hence, the capacitance will be low one moment and high the next. Let us take a variable capacitor consisting of two plates only, which can be rotated in respect of each other. (For certain reasons the plates have a special shape.) It will be clear that when one plate is rotated in relation to the other the capacitance will change. The capacitance will become smaller as the moving plate is turned up.

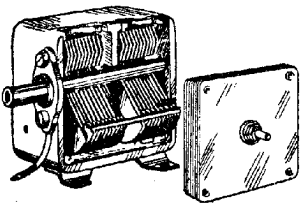

Two variable capacitors: one is air-spaced, the other made with mica.

be insulated by means of mica. Variable mica and air capacitors are both used, even at the same time. A standard variable capacitor has a maximum capacitance of about 500 picofarads (with the moving plates fully turned in) and a minimum capacitance of from 40 to 50 picofarads (with the moving plates fully turned out).

As shown in the preceding illustrations, the variable capacitors of all standard broadcast receivers have a number of plates (two stacks). Practically speaking, this means that the maximum capacitance of these capacitors is considerably greater than that of single-plate capacitors. The insulation between the plates need not necessarily be air; the plates can also

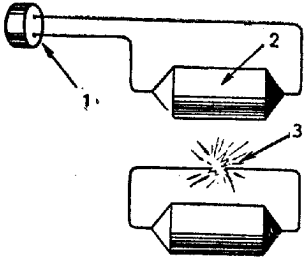

1 = mains supply (direct current).
 2 = capacitor.
 3 = discharge of capacitor.

Capacitors can be charged (filled) with electricity. If a large capacitor is connected for a short time to a direct current source, to charge it up, the charge may be removed by the bringing together of the two connection wires. A fat spark will jump across and the capacitor "discharges". (The same applies to capacitors of small capacitance, except that the discharge is less spectacular.)

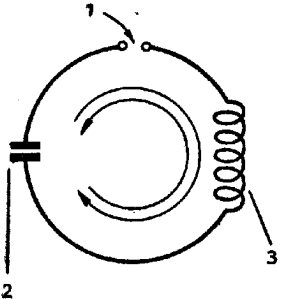

Oscillatory circuit.
 1 = spark gap. 2 = capacitor.
 3 = coil.

Let us revert to our electrical oscillator circuit, consisting of a capacitor and a coil, but in which we have included a small spark gap.

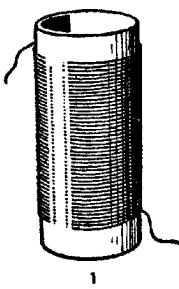

1 = coil. 2 = symbol for a coil.

As shown in the illustration, the coil consists of a cylinder made of insulating material, on which a number of turns of wire have been wound. (The graphical symbol for a coil is a simple line in the form of a spiral.)

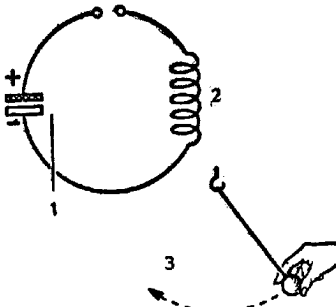

1 = capacitor. 2 = coil.
3 = mechanical equivalent.

Assuming that we have charged the capacitor in some way or other, one section of the capacitor will be positive and the other negative. Translated into mechanical terms, the situation in the oscillator circuit can be represented by a pendulum, which is raised to a given height and held there.

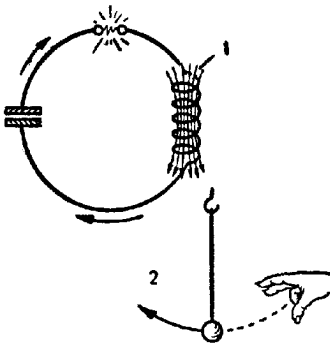

1 = electromagnetic lines of force.
2 = mechanical equivalent.

If the spark gap is made smaller, a spark will jump across and the capacitor will discharge itself, a current of increasing density consequently flowing through the coil. When a current is passed through a coil, an "electromagnetic field" is set up, as we have seen in the section on electromagnetism (when an iron core was introduced into the coil to improve the efficiency of the field). In the mechanical example the pendulum has been released and has reached its lowest point.

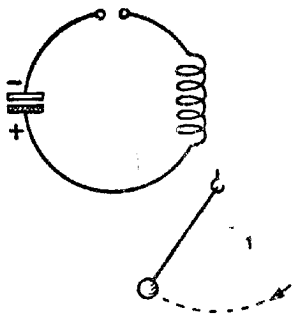

1 = the pendulum reaches its highest point on the other side.

The inertia of the pendulum causes it to pass through its lowest point and swing up on the other side of it. In the electrical circuit the "self-inductance" of the coil (inertia) causes the flow of current to continue: the capacitor is charged in the opposite direction. The pendulum reaches its highest point on the other side.

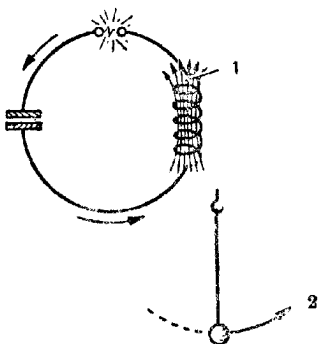

1 = electromagnetic lines of force.
2 = mechanical equivalent.

The process is then repeated in the other direction and so on, until as a result of inherent losses (which can never be entirely avoided) all the energy has been expended. In the mechanical comparison any pendulum will likewise gradually stop swinging (unless it receives a constant supply of new energy from an external source).

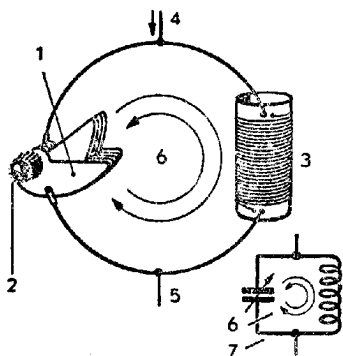

1 = variable capacitor. 2 = control knob. 3 = coil. 4 = oscillatory current input (aerial). 5 = earth. 6 = oscillatory circuit. 7 = circuit diagram.

In the case of the pendulum it is possible to maintain its swinging motion by pushing it at correct intervals. In the electrical oscillatory circuit the same effect can be achieved by continually charging up the capacitor with a uniform rhythm. The electrical oscillations are then sustained. An important point is that the electrical oscillator circuit should be "tuned" to the incoming impulse, i.e. that the capacitor, for example, should be neither too large nor too small. That is why for tuning purposes we use a variable capacitor of which the capacitance can be adjusted. (These two important circuit elements, the coil and the capacitor, will be discussed in greater detail later on.)

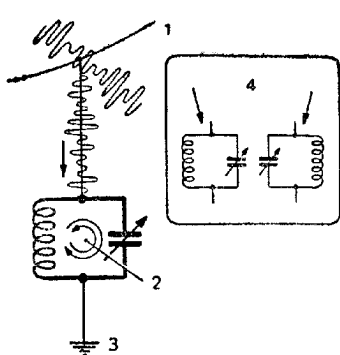

1 = aerial. 2 = oscillatory circuit. 3 = earth. 4 = diagram, may be drawn either way.

It is simply a matter of resonance! We are now acquainted with the most important part of the broadcast receiver, namely the oscillator circuit.

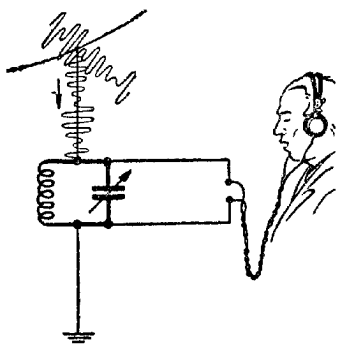

"Can't hear a thing!"

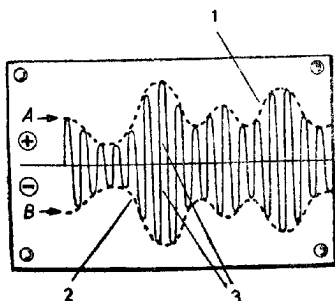

1 and 2 = modulation (with low frequency = audio frequency). 3 = high-frequency oscillations.

Where do we obtain the electrical impulses required? Simply from the supply of broadcast transmitter waves available in the aether. We pick them up with the aid of an aerial and conduct them to the oscillator circuit. If the oscillator circuit is tuned to one of the incoming waves — which may be achieved by adjusting the variable capacitor to the correct setting — powerful oscillations of the same frequency are generated. It is immaterial whether the incoming oscillation is weak or strong.

The transmitter wave carries along with it sound waves in electrical form, which must be separated from it. If by way of experiment we were to connect a pair of headphones to the oscillator circuit, we would not hear a thing.

The illustration shows roughly what the incoming "modulated" high-frequency transmitter wave looks like. The sound wave which it carries along — shown as a dotted line in the positive half (A) — is also present in the negative half (B). In our experiment with the headphones the positive and the negative values cancel each other out.

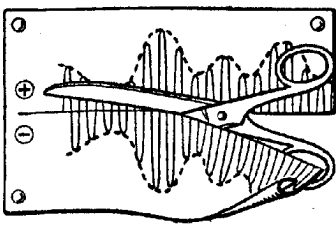

It is necessary, therefore, to cut off, for example, the lower part of the waves. In other words the wave train must be "rectified". The nature of rectification and how this can be achieved has already been explained in the relevant section.

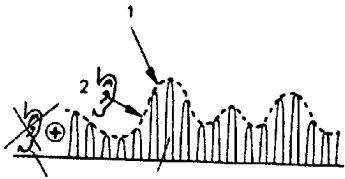

1 = audio-frequency wave (low frequency) which can be converted into audible oscillations.
 2 = half high-frequency wave, cannot be converted into audible oscillations.

When, after rectification, the wave train lies in the positive range, as shown here, the headphones can react to the audio-frequency (low-frequency) wave train. The headphones do not react to the remaining high-frequency waves, because they are much too fast and cannot set the diaphragms in motion. In any case our ears cannot register oscillations faster than 16,000 c/s and the high-frequency carrier wave may have a frequency of between a hundred thousand and millions of c/s!

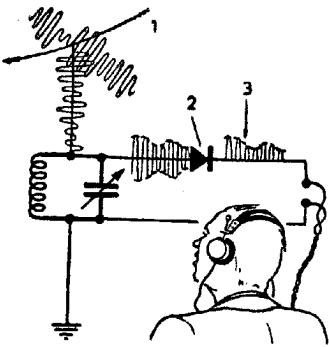

1 = aerial. 2 = detector.
 3 = rectified wave.
 The result is faint, but audible.

In the early days of radio, rectification of the incoming wave train was effected in the receiver by means of a "crystal detector", consisting of a special type of crystal with a thin metal wire pressing on it. Such a "detector" allows current to pass in one direction only. If a detector is incorporated in the circuit, as shown in the illustration, the sound waves brought along by the high-frequency transmitter wave can be made audible in the headphones.

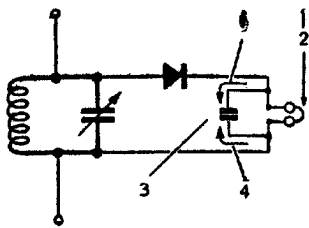

 = 5

1 = headphones. 2 and 4 = remainder of H.F. 3 = capacitor. 5 = symbol for headphones.

a way the capacitor in our circuit is a kind of electrical by-pass. The efficiency of this by-pass is further increased owing to the fact that the coil in the headphones, with its large number of turns, acts as a brake to the high-frequency waves and either allows them to pass with great difficulty or blocks their passage altogether.

The "receiver" can be further improved by connection of a small fixed capacitor in "parallel" with the headphones. A characteristic feature of capacitors is that they will pass electrical waves of high frequency much better than those of low frequency, while, furthermore, the quantity of low frequency waves passed is greater according as the capacitance is higher. The parallel capacitor must, therefore, be of the correct value. In



A tube, however, is a better detector!

How the crystal detector can be replaced by a tube, which in addition to its function as a rectifier also acts as an amplifier, will be discussed later.

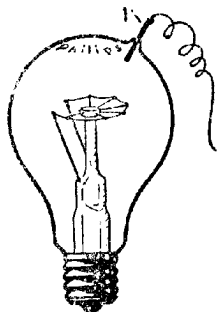

1 = metal pin.

This illustration shows an ordinary incandescent lamp with a metal pin protruding through the glass envelope without impairing the vacuum inside the bulb.



We will now have to become a little scientific, but there is no need for anxiety, because it is all quite easy to understand if you remember what was discussed in the chapter on electrical fundamentals.

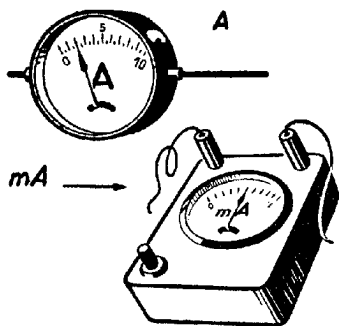

An electric current flowing through a conductor can be measured with the aid of a current meter, or ampere-meter. For weak currents a similar instrument is used, which is called a "milliammeter". Unlike the ammeter, which indicates the current in amperes, the latter instrument indicates the current in milliamperes.

A = ampere-meter, measures strong currents. mA = milliammeter measures weak currents (1 mA = 1/1,000 A).

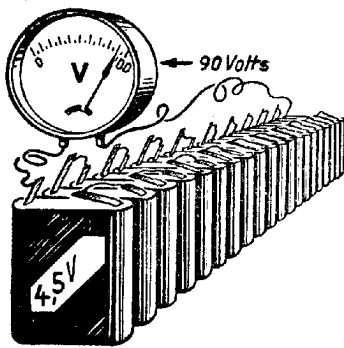

For the following experiments we require a number of torch batteries (about 20). By connecting these 4.5-volt batteries in series (one behind the other) we can build up a large battery with a high total voltage (20 batteries of 4.5 volts produce a total of 90 volts).

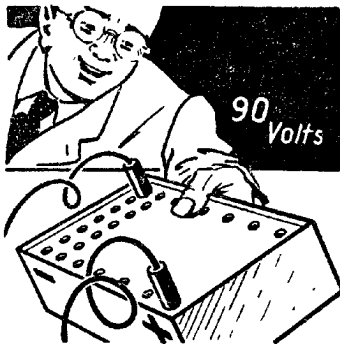

We can save ourselves the trouble by buying a ready-made 90-volt battery in a radio shop. Such a battery is composed of a large number of small individual elements, as may also be found in an ordinary torch battery. This "high-tension battery" is used, for example, in portable radios. In the early days of radio all radio sets were operated on a high tension battery.

High-tension battery of 90 V.

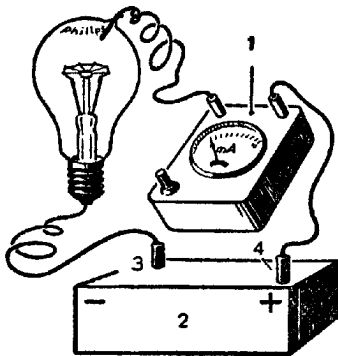

We shall now use the high-tension battery and the milliammeter to carry out experiments with the specially prepared incandescent lamp. We shall build up the circuit shown in the illustration. Will the milliammeter indicate a flow of current? Certainly not, because the connection is interrupted and thus the circuit is not closed.

- 1 = milliammeter.
- 2 = high-tension battery.
- 3 = negative terminal.
- 4 = positive terminal.

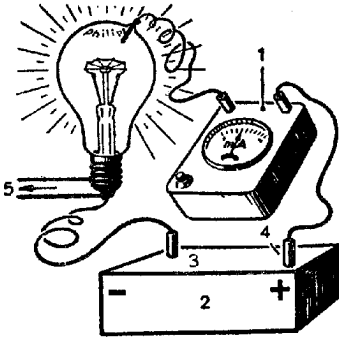

1 = milliammeter. 2 = high-tension battery. 3 = Negative terminal. 4 = positive terminal. 5 = to mains supply.

However, if, the lamp is made to light up by connecting it to the mains in the usual way, we shall see something quite remarkable, viz. the milliammeter will show a reading, which means that there is a flow of electric current. The gap in the circuit between the filament and the metal pin must have been closed in some way. But how?

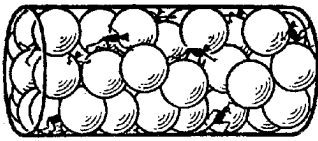

A little theoretical knowledge will not do any harm! In so far as the present state of science permits, we shall, therefore, first explain what electric current really is. The smallest particles, present in a

length of copper wire for example, are the atoms, and the wire can therefore be regarded as a mass of copper atoms lying close together with sufficient space in between to accommodate the "electrons", which are much smaller still. In the illustration the electrons are shown as little black men.

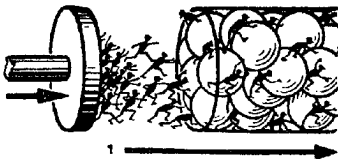

1 = current of electrons.

If a fresh supply of electrons is forced into the wire at one end, those already present in the wire will start to move and a flow of electrons, i.e. a flow of current, will result. This is the case, for example, when electrons are forced

to move by a generator, which can be regarded as an electricity pump. In an electrical circuit the electron current, i.e. the electric current, invariably flows from negative (—) to positive (+). This knowledge enables us to explain what happened in our experimental lamp and to provide the missing link in what we thought was an open circuit!

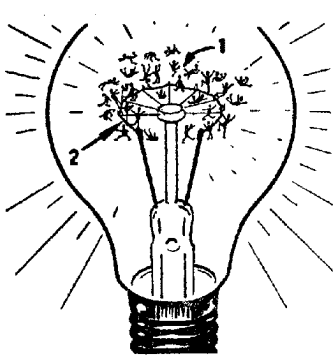

1 = electrons. 2 = filament.

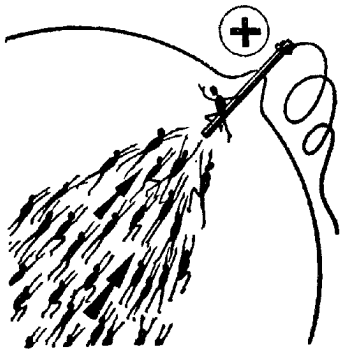

Electrons

"Come on, plenty of room here!"

Electrons are, of course, also present in the filament of the lamp. As soon as the filament is heated the electrons will leave it and large numbers of them will form a cloud round the filament.

At the top of the bulb, however, there is a point of attraction for the electron men, viz. the metal pin which is connected to the positive pole of the high-tension battery. There is a shortage of electrons there and the "free" electrons will try to fill the vacancies thus provided.

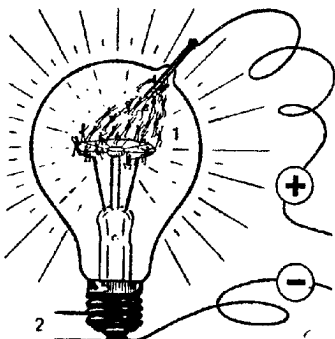

1 = current of electrons.
2 = to mains-supply.

That is why the electrons will not stay in the vicinity of the filament for long, but will make for the metal pin, in which they disappear. Fresh electrons will follow their example.

The circuit is closed

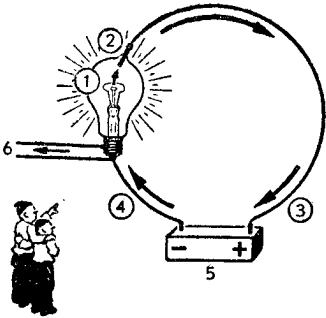

1 = lamp. 2 = metal pin. 3 = positive pole. 4 = negative pole. 5 = high-tension battery. 6 = filament current circuit to mains supply.

The electron current circuit is closed. The electrons “flow” from the filament through the vacuum in the lamp (1) via the metal pin (2) and the connection wire to the high-tension battery (5) and from there back to the filament. In this case the high-tension battery acts as an electric pump which sustains the circuit current.

In the wire the electrons flow to

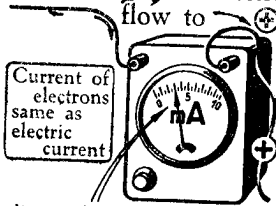

Indicates the current of electrons
The more electrons in the current,
the greater the deflection

The electron current is equivalent to the “electric current”, which explains why the milliammeter incorporated in the circuit shows a reading. It indicates that there is a flow of current and also shows the density of that current, say, 5 mA (5 milliamperes).

Anode current circuit

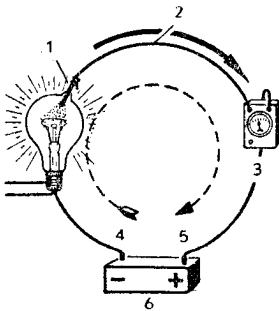

1 = anode. 2 = anode current. 3 = measuring instrument. 4 = negative pole. 5 = positive pole. 6 = high-tension battery.

The metal pin is called the “anode”, while the current flowing through it is referred to as the “anode current”.

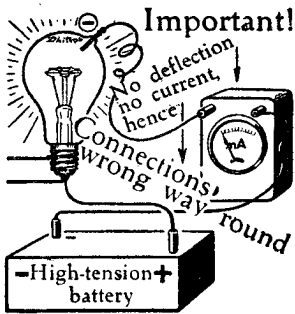

If by way of experiment we reverse the connections on the high tension battery, so that the negative pole is connected to the "anode" (via the milliammeter), it will be seen that no current flows in the anode circuit (the instrument does not show a reading)!

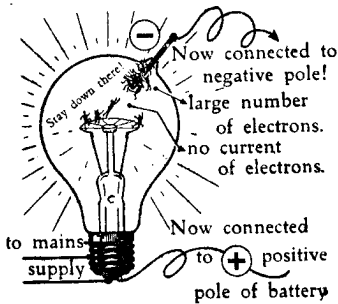

The reason for this is that a large number of electrons collect at the negative pole, causing a surplus of electrons there! The electron men sitting on the anode defend their territory and repel the few electrons which try to move up from the filament. It is essential, therefore, that the positive pole of the high-tension battery should be connected to the anode and the negative pole to the filament, so as to ensure a shortage of electrons at the anode and a surplus of electrons at the filament.

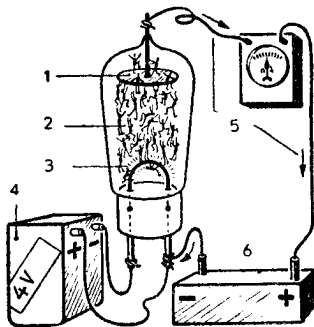

1 = anode. 2 = electron current. 3 = cathode. 4 = filament battery of 4 volts. 5 = anode current. 6 = high-tension battery.

The density of the electron current in the tube can be further raised by construction of the anode in the form of a plate and selection of a special material for the filament, which, when heated, is capable of emitting a large number of electrons. The filament, by the way, is commonly referred to as the "cathode"; it has been so dimensioned that it can be made to glow by means of a small battery, which is called the "filament battery", or the low-tension battery.

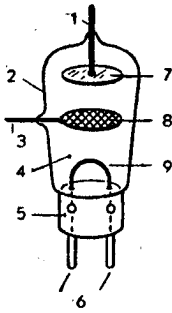

1 = anode connection. 2 = glass envelope. 3 = grid connection. 4 = vacuum. 5 = base. 6 = cathode connections. 7 = anode. 8 = grid. 9 = cathode.

We can now go a stage further, following the example of the inventor, by incorporating in the tube a grid-like device between the "anode" and the "cathode". This grid likewise has a connection protruding through the glass envelope of the tube.

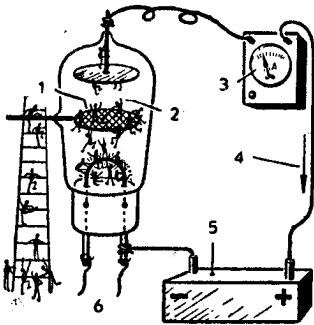

1 = greater negative grid bias
2 = no electron current. 3 = smaller deflection. 4 = weak anode current. 5 = high-tension battery. 6 = to filament battery.

Now we can continue our experiments by applying a negative charge to the "grid", i.e. by sending electrons to the grid. What happens now? The electrons collecting on the grid will block the passage of the electrons from the filament, so that only a few of them will succeed in reaching the anode. Most of them are repelled.

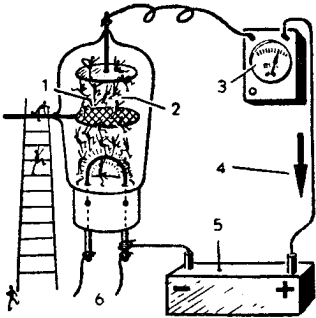

1 = small negative grid bias.
2 = greater electron current. 3 = greater deflection of meter. 4 = greater anode current. 5 = high-tension battery. 6 = to filament battery.

If the electrons on the grid are small in number (small negative charge), more filament electrons will succeed in passing through the grid, and the electron current between the cathode and the anode will be relatively strong (thus the "anode current" in the "anode circuit" will also be strong).

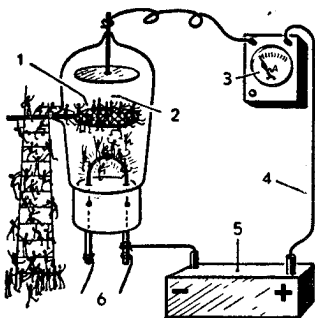

1 = very great negative bias.
 2 = no electron current. 3 = no deflection of meter. 4 = no anode current. 5 = high-tension battery.
 6 = to filament battery.

If the grid is occupied by a very large number of electrons, it may be that the filament electrons will find the way to the anode completely barred. The electron current within the tube will be weaker or stronger according as the electron charge on the grid is smaller or greater. The same applies to the current in the "anode circuit".

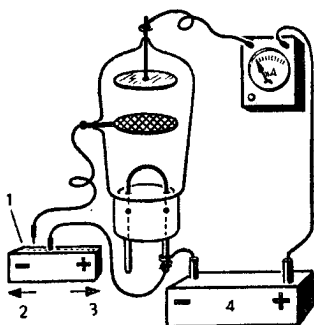

1 = grid bias. 2 and 3: charge on grid can be made more negative or more positive, viz. smaller or greater. 4 = high-tension battery.

In practice the grid "charge" can be regulated in a simple manner. To do this a third battery (grid bias battery) is incorporated and connected to the cathode. The circuit is then so arranged that the charge on the grid can be made smaller or greater at will. Moreover, the flow of electrons to the anode is accelerated when a positive charge is applied to the grid, i.e. when there is a shortage of electrons on the grid.

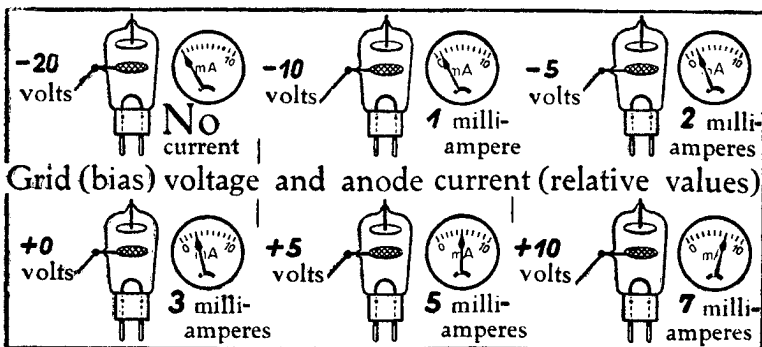

The grid acts more or less like a gate, and the electron current is controlled by opening of this gate to a greater or lesser extent. With a positive charge the grid actually attracts the electrons and thus stimulates their flow.

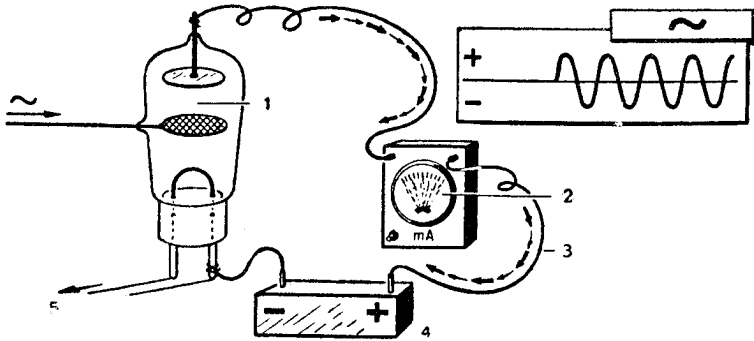

\sim = alternating stronger and weaker current.
 1 = alternating + and - charge. 2 = pointer swings to and fro, indicating changing value of anode current. 3 = changing value of electron current.
 4 = high-tension battery. 5 = to filament battery.

When an alternating voltage is applied to the grid, this will be positive one moment and negative the next. (As already stated, alternating current constantly changes its direction!!)

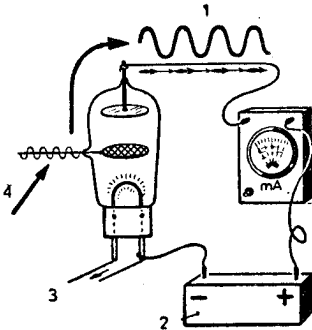

1 = anode current. 2 = high-tension battery. 3 = to filament supply. 4 = input signal.

The alternating voltage applied to the grid will be reflected in the anode circuit in the form of a strong alternating current.

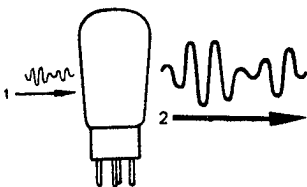

1 = coming-in of current.
 2 = going-out of current.

It is possible, therefore, to employ an "electronic tube" to control the current in another circuit. The alternating voltages applied can be quite low and will yet produce a much stronger anode current identical in form. The operation of the "amplifier tube" is based on this principle.

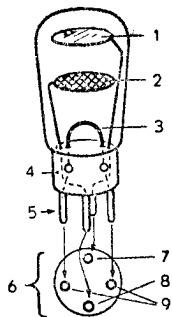

1 = anode. 2 = grid. 3 = filament. 4 = base. 5 = prong. 6 = base seen from below. 7 = anode. 8 = grid. 9 = cathode.

The construction of the modern electronic tube is quite different from that shown in the preceding illustrations. The connections of the anode, the grid and the filament are actually incorporated in the base, for example in the form of prongs (known as "pins").

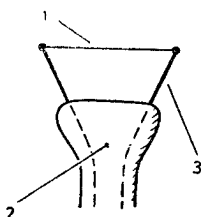

1 = filament. 2 = seal (glass). 3 = support (and current conductor).

In the course of time the constructional elements within the tube have been given a more suitable form, for the sake of more efficient operation. The filament was given an elongated form.

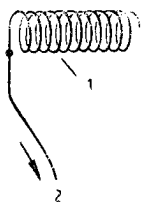

1 = grid (spiral wire). 2 = to seal (of glass).

The grid was constructed in the form of a spiral placed around, and at a short distance from, the filament.

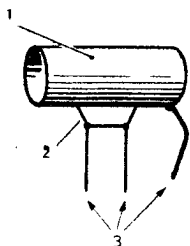

1 = anode (metal cylinder). 2 = anchoring. 3 = to seal.

The anode was made into a cylinder and likewise placed around, and at a short distance, from the grid.

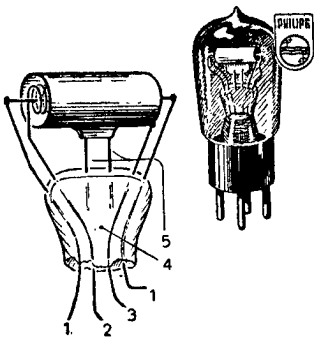

1 = filament. 2 = grid. 3 = anode.
4 = glass seal. 5 = anchoring.

The somewhat diagrammatic illustration on the left shows the construction of a simple tube. The connection wires for the filament, the grid and the anode are passed through a glass seal (the "pinch") to the contacts in the tube base.

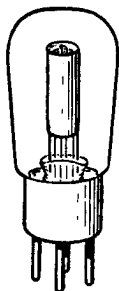

The electrode assembly can also be mounted vertically inside the glass envelope.

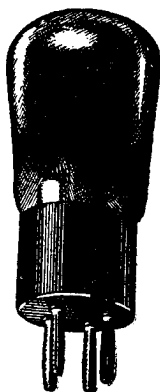

This electronic tube of simple design represents the triple electrode tube or "triode" (three electrodes: filament, grid and anode). In the modern type of tube the base contacts usually have a different form.

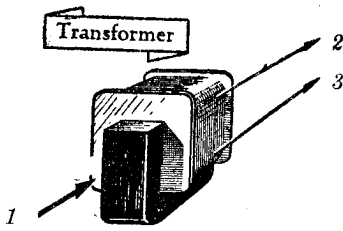

1 = alternating mains current of 250 V, 127 V or 110 V.
 2 = heater voltage of 6.3 V.
 3 = anode voltage converted into direct current.

In modern A.C.-sets all the voltages required to operate the tubes are supplied via transformers, viz. alternating current for heating the filaments and alternating current of high voltage, which, after having been rectified, furnishes the D.C.-supply for the anode circuit.

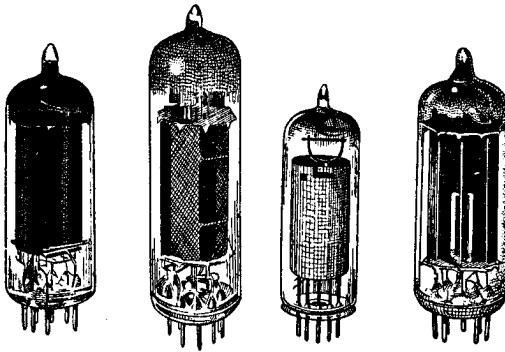

1 = mixing tube. 2 and 3 = amplifying tubes.
 4 = rectifying tube.

The various applications of these tubes, of which for certain reasons the glass envelopes are partly silvered on the inside, will be discussed in the following sections.



Philips tubes are manufactured to very high quality standards and the Philips production programme includes tubes for all applications.

F: The single-tube receiver

Circuit with diode.

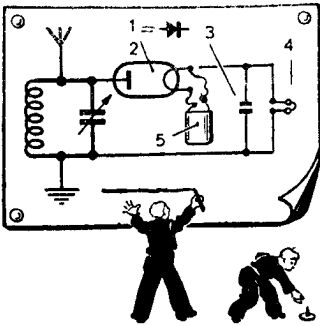

- 1 = graphical representation of a tube. 2 = twin-electrode tube.
3 = capacitor. 4 = headphones.
5 = filament battery.

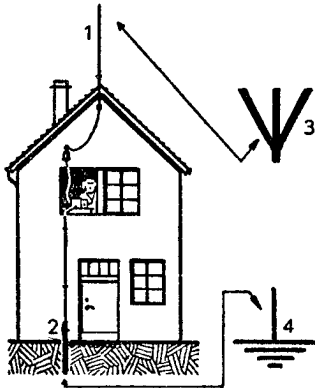

- 1 = aerial: 2 = earth. 3 = symbol for "Aerial". 4 = symbol for "Earth".



Diode



Triode

We are already acquainted with the use of the electronic tube for rectification purposes. It will be clear, therefore, that it can be used to replace the crystal detector in a receiver. In practice this is actually possible. If the components are arranged as shown in the circuit diagram, the device can be made to operate even without an anode voltage source. The voltages required are furnished by the incoming waves. The filament of the gridless tube, which is referred to as a "twin-electrode tube" or "diode", must of course be heated and a filament battery must, therefore, be provided.

The circuit diagram shows two new graphical symbols, namely: the one for the aerial — which is represented simply by an arrow-head pointing downwards — and the one for "earth".

The application of a tube (diode) in the above circuit diagram in the place of the crystal detector offers no advantages, while, moreover, a battery is required. We have now come to the stage where we should study the properties of the "triode" tube, which, besides the anode and the cathode, has a grid (hence three electrodes).

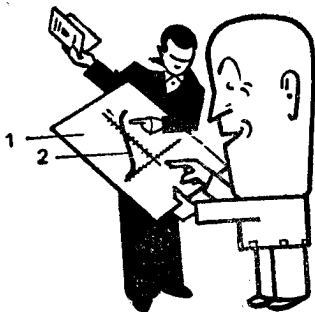

1 = identity card.
2 = characteristic of this tube.

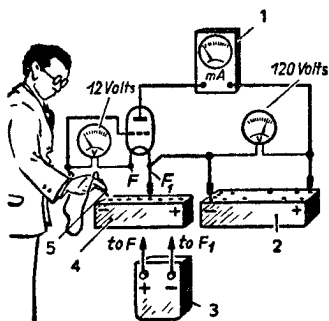

1 = milliammeter. 2 = high-tension battery. 3 = filament battery. 4 = grid battery to F and F1. 5 = negative grid bias.

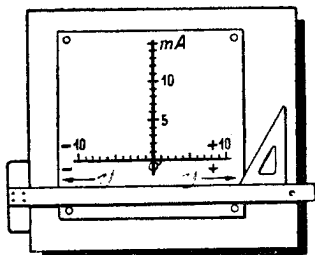

A little more theory will be required to enable us to understand the operation of the tubes employed in the various receiver circuits. This theory will be explained with the aid of some experiments. Each tube has its "characteristic", which can be regarded as its identity card since it furnishes information concerning its most important properties.

If we wish to plot the characteristic of a triode, we must build up a circuit which in principle is similar to those shown in connection with previous experiments. The anode voltage is furnished by a high-tension battery and the grid-bias voltage by a grid-bias battery, which is so arranged that either negative or positive voltages can be applied to the grid of the tube. A milliammeter is incorporated in the anode circuit to enable the current values, which must be known for assessment of the tube, to be accurately determined; the grid-bias and anode voltages are read from two appropriate voltmeters.

We now take a sheet of paper, on which we draw a horizontal and a vertical axis. The horizontal axis is divided to show the grid-bias voltage values; the positive values are set out to the right of the zero point in the centre and the negative values to the left. The vertical axis is divided into milliamperes.

We can now go to work. The tube is first "heated". A negative grid-bias voltage of, say, minus 10 volts is applied by means of plug G.

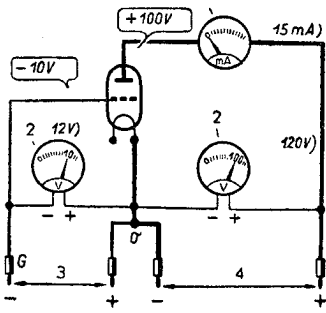

1 = milliammeter (max. 15 mA).
 2 = 2 voltmeters, 12 and 120 V,
 resp. 3 = grid voltage. 4 =
 anode voltage. G = plug.

The anode voltage should be 100 volts. (The reader should now be sufficiently advanced to be able to read the simplified diagram shown.) The milliammeter does not show a reading and the reason for this is that the high negative bias of the grid makes the passage of the filament electrons impossible. There is no flow of electrons to the anode and thus no anode current in the anode circuit.

Grid voltage (V _g)	Anode-current circuit (I _a)
Volts	Milliamperes
10	0
9	0
6	1
3	3
0	6
3	8,5
6	9,6
9	10
10	10

After adjusting the grid-bias voltage to minus 9 volts we once more check the milliammeter and again it does not show a reading. We thereupon adjust the grid bias to minus 6 volts, whilst maintaining the anode voltage at a constant value. This time the milliammeter indicates a current of 1 mA (milliampere). With a grid bias of -3 volts the anode current rises to 3 mA and at 0 V the anode current is 6 mA. We then apply a positive grid bias of +3 volts,

which results in an anode current of 8.5 mA. With a grid bias of +6 volts we record a reading of 9.6 mA and with +9 volts this is 10 mA. The readings thus obtained will suffice for the present. The values have in the meantime been recorded in the form of a table, with the grid-bias values on the left and the corresponding anode-current values on the right.

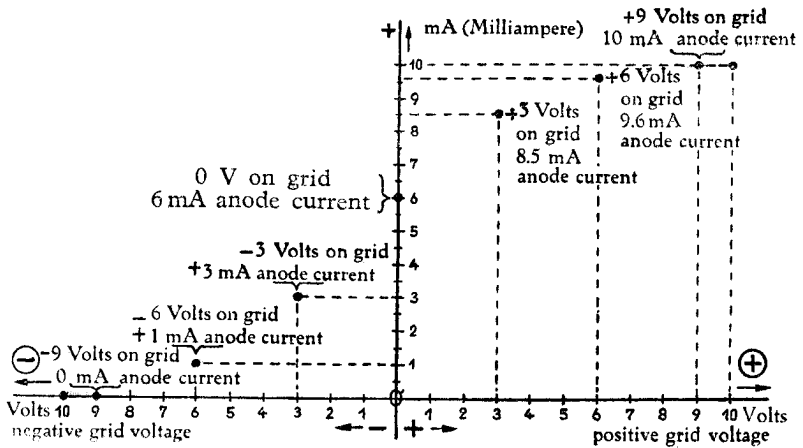

We can now use this table to plot the values found in the system of axes referred to above. This is done by finding the appropriate points in the system of axes for each of the values in turn and marking these points with a dot.

Minus 10 volts grid bias will be found at -10 on the extreme left of the horizontal axis. The corresponding anode current is 0 mA, which lies at the point of intersection of the horizontal and the vertical axis. The dot for -10 volts should therefore be placed on the horizontal axis. The same applies to -9 volts, since in this case, too, the anode current is zero. For minus 6 volts grid bias we place a dot in the "graph" directly above -6 volts at a level corresponding to 1 mA. We do the same for -3 volts grid bias at the level of 3 mA and so on, as shown in the above illustration.

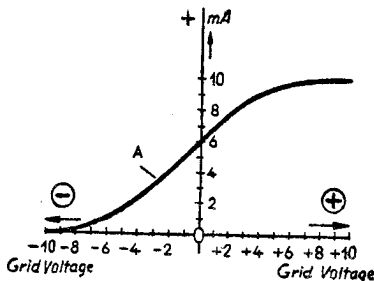

A = characteristic.

The points thus found are connected by means of a curve and the characteristic of our tube is complete. Naturally, it only applies for an anode voltage of 100 volts.

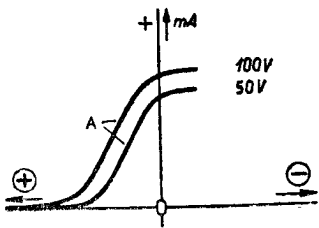

A = characteristic.

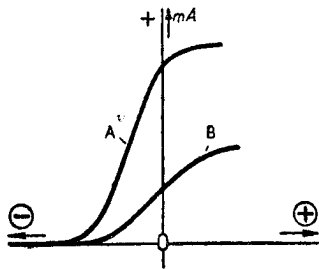

Tube A with a steep characteristic.
Tube B with a flat characteristic.

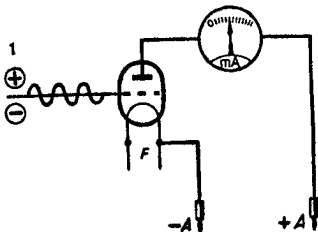

1 = alternating voltage.

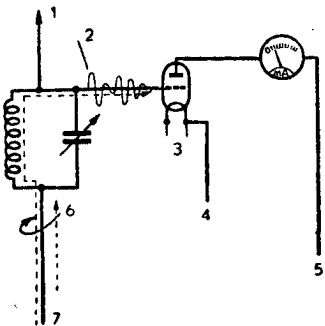

1 = to aerial. 2 = alternating oscillations. 3 = to filament battery. 4 = to negative terminal of anode voltage source. 5 = to positive terminal of anode voltage source. 6 = shows how grid voltage goes to the grid. 7 = to negative grid bias.

With a different anode voltage of, say, 50 volts, it would have the same appearance, but be located more to the right.

The "grid bias — anode current" characteristic of a tube is steeper or flatter according as the properties of the tube are different. (The tube characteristic can also be represented in a different way.) The steeper and straighter the characteristic (at least in its principal part), the more suitable the corresponding tube will be for our purposes, as will be evident from the following pages.

What happens when we apply an alternating voltage to the grid tube?

This can be done, for example, by means of an oscillatory circuit, in which oscillations are set up by a transmitter wave picked up by an aerial. In this theoretical experiment we apply a given negative bias to the grid.

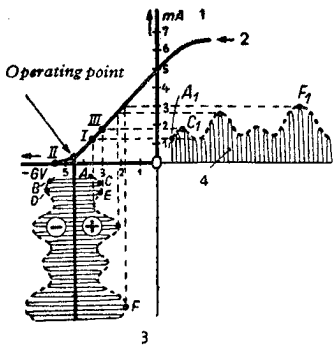

1 = anode current. 2 = characteristic. 3 = high-frequency alternating voltage curve. 4 = rectified, amplified alternating voltage curve.

new grid-bias voltage corresponds to point 1 on the characteristic, i.e. to an anode current of about 1.2 mA (as may be seen from the vertical axis). The value of 1 volt at B on the high-frequency alternating voltage curve increases the grid bias by 1 volt on the negative side. At this point the grid bias is -5.5 volts, at which value the anode current (II) is zero. At C the alternating voltage is $+1.5$ volts, so that the grid bias is -5.5 volts, at which value the anode current (II) is zero. At C the alternating voltage is $+1.5$ volts, so that the grid-bias voltage is then -3 volts (-4.5 volts $+ 1.5$ volts). In this case the corresponding anode current is about 1.8 mA (III and C1). The next moment, at D, the negative grid-bias value is once more reached, so that no anode current flows. The flow of anode current will not be resumed until the alternating-voltage curve has passed into the positive range.

Superimposed on a tube characteristic, the situation presents a picture which is not so difficult to understand if we care to take the trouble to study it carefully. The voltage on the grid of the tube is -4.5 volts. The alternating voltages of the modulated transmitter wave arrive at the grid and affect the value of the grid-bias voltage by their alternate positive and negative values. How this takes place may be seen from the lower part of the illustration. At A a positive half-wave has added 1 volt to the original grid-bias voltage, which is now no longer -4.5 volts but -3.5 volts. This

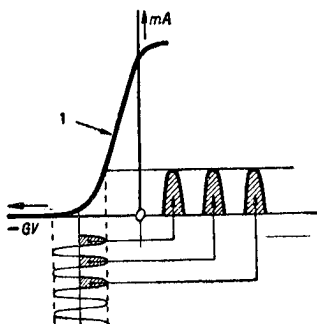

1 = steep characteristic.

Thus, the negative wave components of the incoming signal are cut off: rectification. At the same time the original weak waves are amplified and their amplitude in the anode circuit will be greater as the characteristic is steeper.

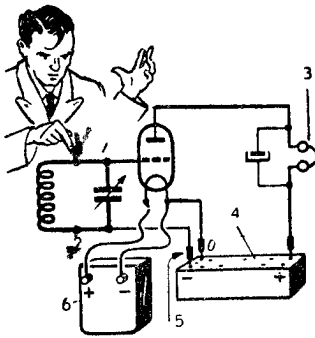

1 = aerial (not shown). 2 = earth (not shown). 3 = headphones. 4 = high-tension battery. 5 = from grid-bias battery. 6 = filament battery.

This type of rectification is called "anode detection". The relevant circuit is shown in the illustration. There are two important points about this circuit, namely, the aerial (1) and earth (2) are not shown (we will revert to this later) and the grid-bias battery is also absent (5). This battery is not essential and, provided the circuit is suitably arranged, a high-tension battery and a filament battery will suffice.

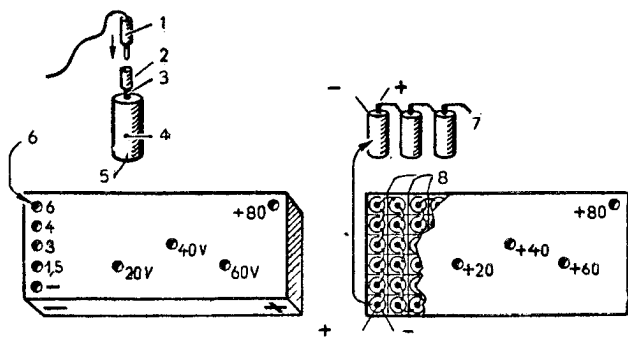

1 = plug. 2 = socket clamped on. 3 = carbon = positive pole. 4 = zinc case = negative pole. 5 = single cell. 6 = single cell below this point. 7 = single cells connected in series. 8 = insulation.

The construction of some types of high-tension batteries is such that a number of different voltages can be selected at will. These batteries consist of a number of individual elements, which are connected in series. Each of these elements furnishes about 1.5 volts. Thus, the tension between the minus socket and the socket on the first "cell" is +1.5 volts. Likewise, voltage tappings of +3, +4.5 and +6 volts are available on the second, third and fourth cells, respectively.

Many high-tension batteries are already marked accordingly: + 74 Volts.

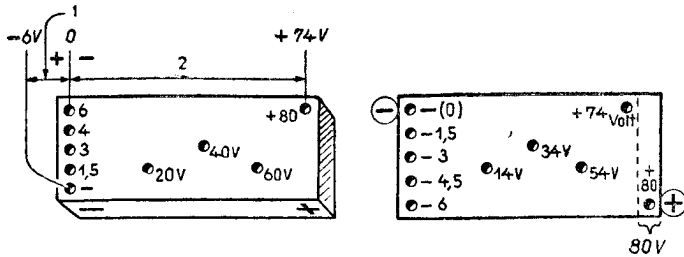

High-tension battery. Enlarged by 5 cells to 80 volts voltage.
1 = grid voltage. 2 = anode voltage.

By shifting the minus connection to the + 6-volt socket it is possible to select different negative-voltage values down to - 6 volts (grid bias), in which case the anode voltage is, of course, reduced by 6 volts.

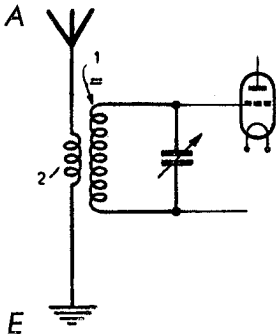

1 oscillator circuit coil = tuning coil. 2 = aerial coil.

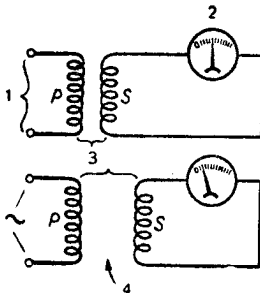

1 = to alternating-current source.
2 = measuring instrument shows deflection. 3 = coupling. 4 = loose coupling (slight deflection).
S = induction in the secondary winding.

In the previous circuit diagram the aerial was connected direct to the oscillatory circuit (viz. at A; "earth" at E), but this is not done in practice. The incoming signal from the aerial is fed to a separate aerial coil, which is "coupled" to the coil of the oscillator circuit.

An alternating current passing through a coil will set up an alternating voltage in a neighbouring coil, as has been previously explained in connection with alternating current and transformers. In this case, however, a common iron core was introduced in the coils to improve the efficiency of the magnetic field. The tighter the coupling, the greater the effect on the second coil (secondary coil).

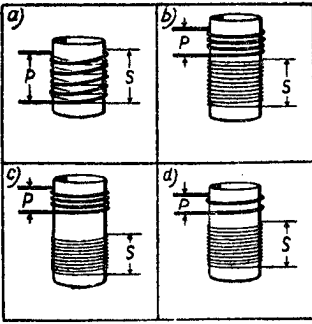

a = "tight" coupling. b = medium coupling. c = "loose" coupling. d = "loose" coupling.

The "degree of coupling" can be reduced or increased in a number of ways. If the two windings of the coil (insulated from each other) are tightly wound over each other (a), a high degree of coupling will result (the coupling is "tight"). If the primary winding *P* is located at a certain distance from the secondary winding, the degree of coupling will be smaller (b) and it is said that the coupling is "loose". A further increase in the distance between the windings will reduce the coupling still further (c and d).

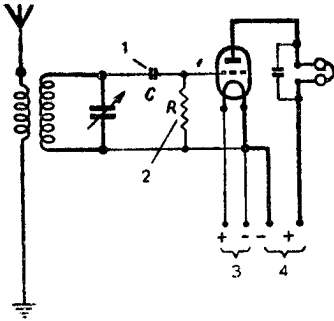

Audio circuit.

1 = grid capacitor. 2 = grid resistor. 3 = filament battery. 4 = high-tension battery.

*C = capacitor.
R = grid-leak resistor.*

In practice this initial coil design is now hardly ever used. More up-to-date designs are employed, which will be referred to later. At this stage it is more important to mention a second type of HF detection circuit, viz. that of grid-leak detection or grid detection. It is more sensitive than the anode detection circuit, while, moreover, the amplification is better. The principles of grid detection are rather complicated and it will suffice here merely to show the circuit diagram concerned, in which no special provision for grid bias need be made. The oscillations of the oscillatory circuit are passed to the grid via a small capacitor *C*, which permits the passage of high frequency oscillations. The circuit further requires a "grid-leak resistor" *R*.

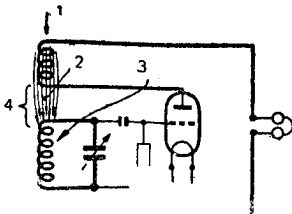

1 = reaction coil. 2 = reaction coil couples back to coil 3. 3 = feedback coil. 4 = coupling.

The circuit will be more sensitive if a so-called "reaction coil" (1) is incorporated. This name will be clear when it is considered that part of the high-frequency half-waves in the anode circuit are made to "react" on the oscillator circuit via a "feedback coil" (3), which is coupled in a special manner.



The coupling can be loose or tight. If it is too tight, the set will produce the familiar reaction howl, which is heard not only by the listener himself, but also by his fellow-listeners in the neighbourhood. Fortunately there are now few receivers with reaction circuits.

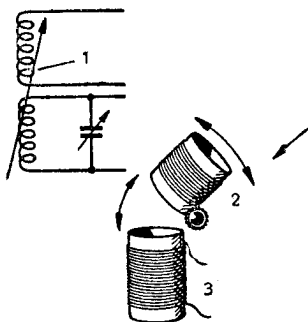

1 = degree of coupling between coils made variable. 2 = moving part, attached to control knob. 3 = fixed part.

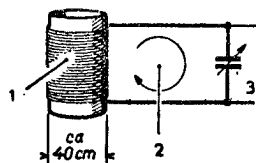

For medium waves!
1 = 70 turns. 2 = tuned circuit.
3 = variable capacitor with maximum capacitance of 500 pF.

To indicate in the circuit that the coupling of two coils can be varied, an arrow is drawn through them. Such an arrow in a graphical symbol always indicates that the component concerned is variable (as in the case of the variable capacitor).

So far nothing has been said about the wave ranges for which the single-tube receiver described here is suitable. This, however, is dependent upon the number of turns on the coil in the tuned circuit and on the capacitance of the variable capacitor. Generally speaking, the standard variable capacitors employed have a maximum capacitance of about 500 pF. (when the rotor plates are fully turned in). The minimum capacitance generally lies between 40 and 50 pF. (when the rotor plates are fully turned out). The coils of the type so far described here, with a diameter of 40 mm, require about 70 turns of insulated copper wire (about 0.3 mm in diameter) for reception of the medium wave band.

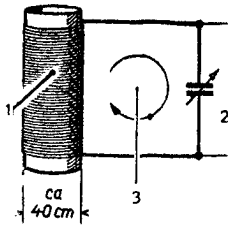

For long waves!
 1 = 200 turns. 2 = variable coil
 with maximum capacitance of
 500 pF. 3 = tuned circuit.

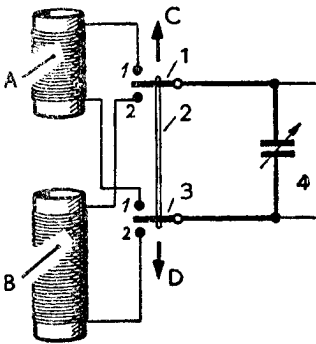

A = medium-wave coil. B =
 long-wave coil. C = medium
 wave switch. D = long wave,
 1 and 3: switches. 2 = insulated
 strip. 4 = max. 500 pF.
 Switch positions: 1-1 = me-
 dium wave. 2-2 = long wave.

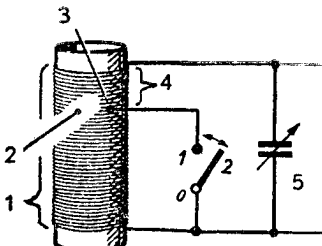

1 = single coil. 2 = 200 turns.
 3 = tapping. 4 = 70 turns for
 reception of medium waves. 5 =
 variable coil of max. 500 pF.
 Switch positions:
 0-1 = medium wave.
 0-2 = long wave.

For the "long" wave" band the
 coil should have as many as 200
 turns.

If a radio set is required to cover
 both the medium wave and the
 long wave band, it will have to be
 equipped with a wave-range
 switch, whereby the set can be
 switched from one band to the
 other. In the "medium-wave"
 position the coil with the small
 number of turns is connected
 to the variable capacitor to
 form a tuned circuit, while
 in the "long-wave" position the
 large coil is switched into circuit.

The same result can be achieved
 in a much simpler way, namely by
 the use of a single coil with about
 200 turns, suitable for the long wave
 band. For the reception of medium
 waves the coil is tapped at 70 turns
 and the remaining 130 turns are
 simply switched out of circuit by
 short-circuiting that section of
 the coil.

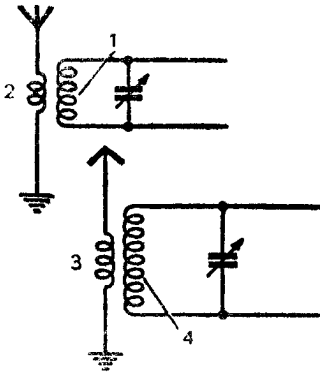

Medium Wave Range.
 1 = 70 turns. 2 = 14 turns.
Long Wave Range.
 3 = 40 turns. 4 = 200 turns.

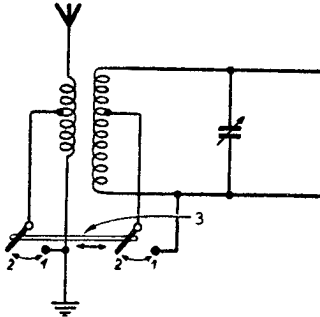

Switch positions:
 1 = medium wave. 2 = long wave. 3 = insulated connecting strip.

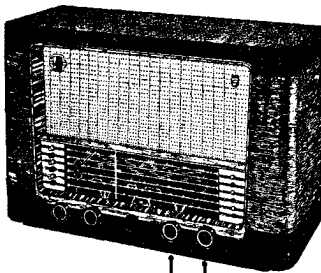

1 = wave range switch. 2 = tuning control.

As stated before, a special aerial coupling coil is used. The number of turns on this coil should be roughly one fifth of that on the coil of the tuned circuit.

For this reason the aerial coil must also be provided with a switching arrangement for wave-changing purposes.

Thus, two switches are employed to short-circuit those sections of the coils which are not required for medium-wave reception. The two switches are operated simultaneously. Similar arrangements must be made in the case of the reaction coil.

It is essential that the switching of a number of contacts should be accomplished by means of a single control, i.e. the wave-range switch.

G: More tubes — better reception!



In the long run neither the crystal set nor the single-tube receiver was able to satisfy the requirements of the radio listener. On the one hand the performance of these sets was inadequate owing to their low sensitivity, while on the other hand much of the pleasure of listening was spoilt by the discomfort caused by the headphones.

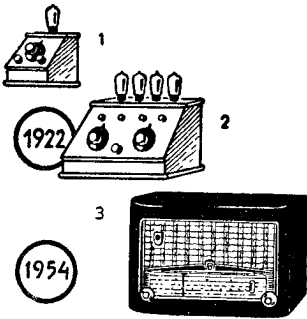

The electronic tube, however, presented great possibilities. In the course of time it was introduced into the receiver to fulfil a wide range of duties. The first receivers of the "larger" types had their tubes neatly arranged in a row on top of the set. Nowadays only the top of the "magic eye" is to be seen!

1 = one-tube receiver as it was in the beginning. 2 = 1922: 4-tube receiver. 3 = 6-tube receiver, 1954, with magic eye.

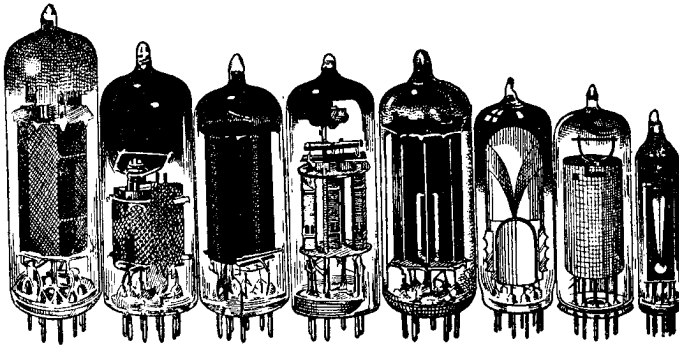

Apart from rectification, the principal task of the electronic tube is "amplification". The tube is capable of amplifying both the weak transmitter waves (high-frequency amplification) and the weak

audio frequencies (low-frequency amplification). Formerly one and the same tube was used as a "maid of all work" to amplify and rectify all types of waves. Nowadays we have a wide range of special types of tubes for every single function.

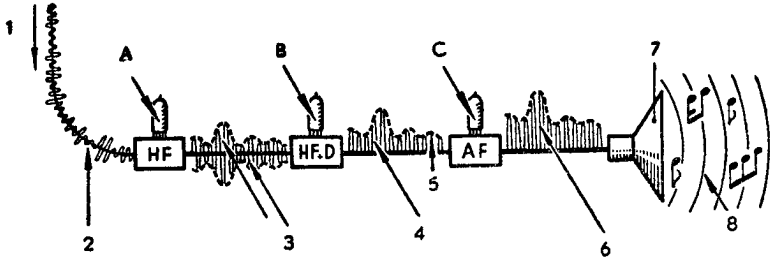

A = HF amplifier stage. B = HF rectifier stage. C = LF amplifier stage. 1 = from aerial. 2 = arrival of weak HF waves. 3 = amplified HF waves. 4 = rectified and amplified HF waves. 5 = LF waves. 6 = amplified LF waves. 7 = loudspeaker. 8 = LF air waves.

The addition of two more tubes to the original single-valve receiver constitutes a considerable contribution towards perfection. The first tube amplifies the weak transmitter waves picked up by the aerial, so that the second tube can do its work more efficiently, while the third tube amplifies the low-frequency waves to a level suitable for loudspeaker reproduction. The receiver now comprises three "stages", each with one tube, namely, the HF amplifier stage, the HF detector stage and the AF stage. Nowadays this circuit is no longer used.

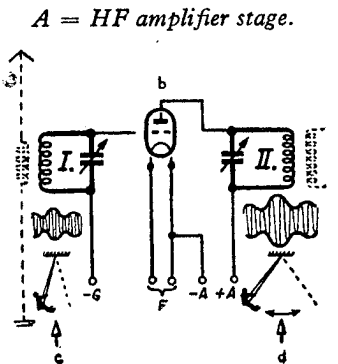

I = first oscillator circuit. II = second oscillator circuit. b = HF amplifier tube. c = weak oscillations. d = stronger oscillations.

We shall deal with the HF stage first. The signal picked up by the aerial is fed to the grid of the high-frequency amplifier tube via the tuned circuit. The anode circuit of the tube comprises a second tuned circuit, in which the oscillations of the transmitter waves are considerably amplified.

B = HF rectification.

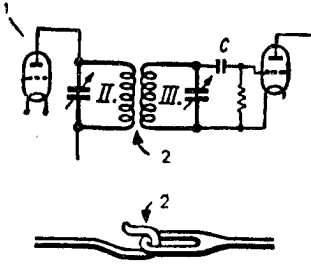

1 = HF ampl. tube followed by detector stage. 2 = coupling.
C = AF amplifier stage.

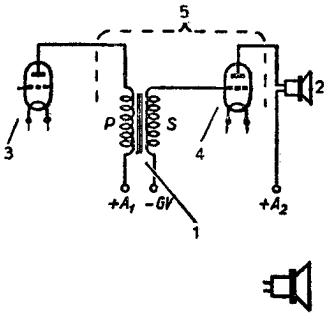

1 = coupled AF transformer. 2 = loudspeaker. 3 = HF rectifier tube. 4 = AF amplifier tube.
P = primary winding taking the place of the headphones.

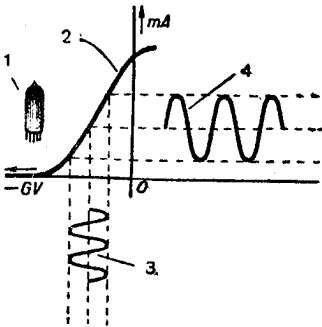

1 = amplifier tube. 2 = characteristic of tube. 3 = wave train to be amplified. 4 = amplified wave train.

The amplified waves of the second tuned circuit can now be passed to the HF detector tube (for example, via the coupled coil of a third tuned circuit), so that this tube receives a much stronger signal than would have been the case without a preceding stage.

The AF amplifier stage can be "coupled" to the detector stage by means of a transformer(1), of which the primary winding takes the place of the headphones (P). In this way the low-frequency waves are transferred to the grid of the AF amplifier tube. The amplified audio-frequency waves are reflected in the anode circuit of the third tube, so that current and voltage fluctuations occur in the loudspeaker. These fluctuations cause the diaphragm of the speaker to vibrate strongly, so that sound of considerable loudness is produced.

The amplification qualities of an AF amplifier tube will be better when the characteristic of the tube is steeper. Its operation is explained theoretically in the illustration. The audio-frequency (low-frequency) voltages applied to the grid of the tube are also encountered in an amplified form in the anode circuit.

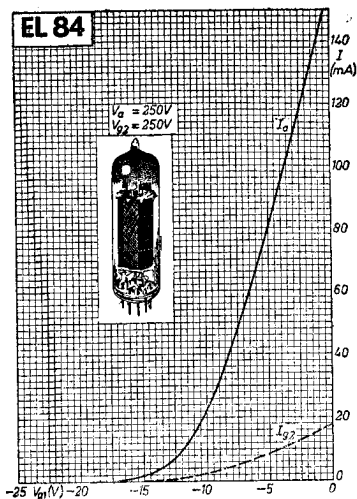

Characteristic of anode voltage. I_a = anode current. I_{g2} = screen-grid current (which will be explained later). V_{g1} = grid bias

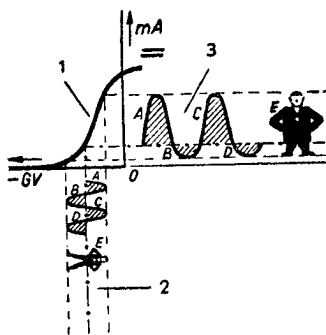

1 = strongly curved characteristic. 2 = wave train A-B-C-D to be amplified. 3 = amplified but distorted wave train A'-B'-C'-D'. E = illustration of the kind of amplification.

The drawing on the left shows the characteristic of the familiar AF amplifier tube EL 84, which is used in "output stages". The anode voltage is 250 volts. The characteristic was plotted at grid voltages of between 0 and 17.5 volts.

An important requirement for the satisfactory operation of a tube is the straightness of its characteristic. (In any case care is taken, by selection of the correct grid voltages, that the tube operates only in the straight part of the characteristic; all characteristics have curved parts, especially at the beginning and at the end.) If the amplifier tube is made to operate in the curved part of its characteristic, the amplified counterpart of the low-frequency waves will be seriously distorted, which results in distorted reproduction.

H: More theory

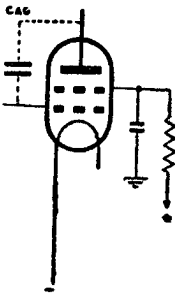
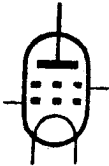
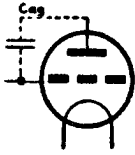

In modern radio sets tubes are used which have more than one grid. The explanation for this is as follows. By now we all know what a capacitor is. It consists of two plates, insulated from each other, which have a certain capacitance dependent on their size. The grid and the anode of a tube are not exactly like the plates of a capacitor, but nevertheless they are two metal objects insulated from each other and thus they have a certain capacitance. This is called the anode to grid capacitance and is briefly indicated by C_{ag} . For triodes this capacitance is between 1.5 and 2.5 $\mu\mu\text{F}$.

Owing to the presence of the C_{ag} the HF amplification of a triode cannot be raised to a very high value, and an attempt was made to solve the difficulty by reducing this capacitance. A screen was incorporated in the tube between the grid and the anode. This screen had to be so designed that electrons could pass through, and it therefore had to have the form of another grid, which was called the screen grid.

Like the chassis of the receiver, this screen grid should really be connected to earth, but if this were done it would repel electrons. It is an essential requirement, however, that the electrons should be attracted and accelerated to such an extent that they fly through the meshes of the screen to the anode. For this reason a positive voltage is applied to the screen grid via a resistor and it is earthed capacitively by means of a large capacitor.

The C_{ag} is now much smaller, viz. 0.001 to 0.005 $\mu\mu\text{F}$.

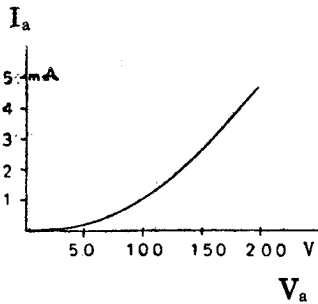

$I_a = \text{anode current. } V_a = \text{anode voltage.}$

A few pages back we drew the characteristic curve of a triode, maintaining the anode voltage at a constant value, and applied different grid voltages. The characteristic shown here is drawn in a similar way, except that the grid voltage is kept constant and the anode voltage raised from zero to 200 volts. The anode current is measured after each change in anode voltage and rises from zero to 5 milliamperes, as may be seen from the curve.

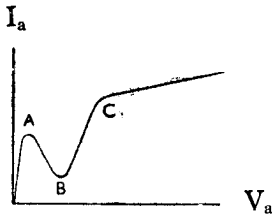

$I_a = \text{anode current. } V_a = \text{anode voltage.}$

In the case of a tetrode, which is the name for the tube with two grids which we have just discussed, this characteristic looks entirely different. If we apply a fixed voltage (of, say, 1 volt) to the first grid (the control grid) and a fixed voltage of 100 volts to the second grid (the screen grid), and next raise the anode voltage from zero

to 200 volts, it will be seen that as the voltage is raised the current first increases. Then something strange occurs! The anode voltage rises further, but the anode current decreases (point *A*). At a given moment (point *B*) the current starts to increase again. Finally, after a rapid increase to point *C*, the current rises at a considerably reduced rate with increasing anode voltage. The part of the characteristic between points *A* and *C* cannot be used in radio circuits and this limits the application of tetrodes considerably.

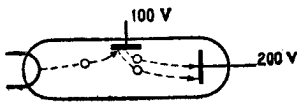

The remarkable anode voltage/anode current characteristic of a tetrode can be explained as follows:

If we fit two anodes in a tube and apply 100 volts to the one nearest the cathode and 200 volts to the other anode, it may happen that an electron from the cathode impinges on the first anode with such force that two other electrons are liberated from its surface.

These two electrons are attracted by the second anode, which is at a higher potential. The liberation of electrons by collision or bombardment is called secondary emission, in contrast to thermal emission, which is caused by heating, (as in the case of the cathode).

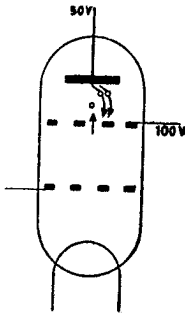

Something similar occurs in a tetrode when the anode voltage is lower than the screen grid voltage. An electron which travels at a high velocity through the meshes of the screen grid impinges on the anode and liberates two other electrons. As the potential of the screen grid is much higher than that of the anode, the two electrons travel to the screen grid, so that the anode current decreases and the screen grid current increases.

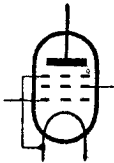

Dr. van Tellegen, of the Philips Laboratory, who wished to eliminate this effect, invented the electronic tube with three grids, which has been given the name "pentode". The third grid, which is located between the screen grid and the anode, is called the suppressor grid. It is usually connected to the cathode. In some cases this connection is made inside the tube, but sometimes the suppressor grid is connected to a contact on the base of the tube.

The function which this suppressor grid performs in the tube may be explained as follows. When secondary electrons are liberated at the anode they will tend to move in the direction of the suppressor grid. The potential of this grid is zero or slightly negative, so that the electrons are slowed down. Owing to the positive potential on the anode, they are once more attracted and cannot travel to the screen grid.

The function which this suppressor grid performs in the tube may be explained as follows. When secondary electrons are liberated at the anode they will tend to move in the direction of the suppressor grid. The potential of this grid is zero or slightly negative, so that the electrons are slowed down. Owing to the positive potential on the anode, they are once more attracted and cannot travel to the screen grid.

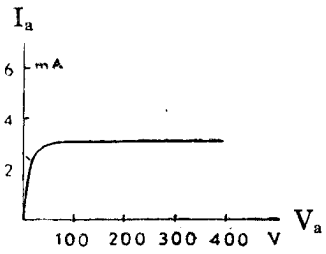

I_a = anode current. V_a = anode voltage.

If the anode-current characteristic of a pentode is plotted with a constant grid bias and with constant screen-grid and suppressor-grid voltages, it will be seen that with increasing anode voltage the anode current rises quickly to a specific value, after which it remains practically constant. The current remains approximately the same, despite changes in the voltage. This is a very favourable property and for this reason most of the tubes in a modern receiver are pentodes. They have a very high amplification factor.

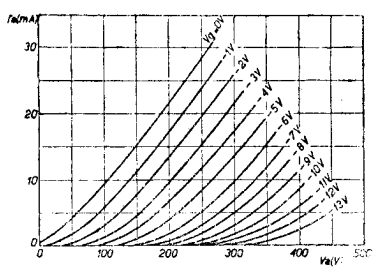

These anode current/anode voltage characteristics are never given for a single grid voltage, but always for a number of grid voltages. In this way a family of curves is obtained. The curves shown in the illustration are those of a triode.

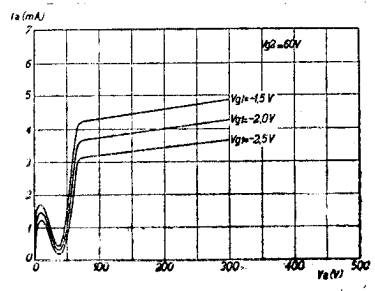

The anode current/anode voltage characteristics shown here are those of a tetrode for several negative grid voltages with constant screen-grid voltage.

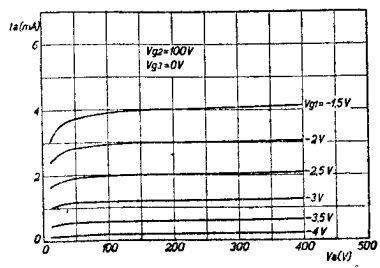

This is the family of curves of a pentode.

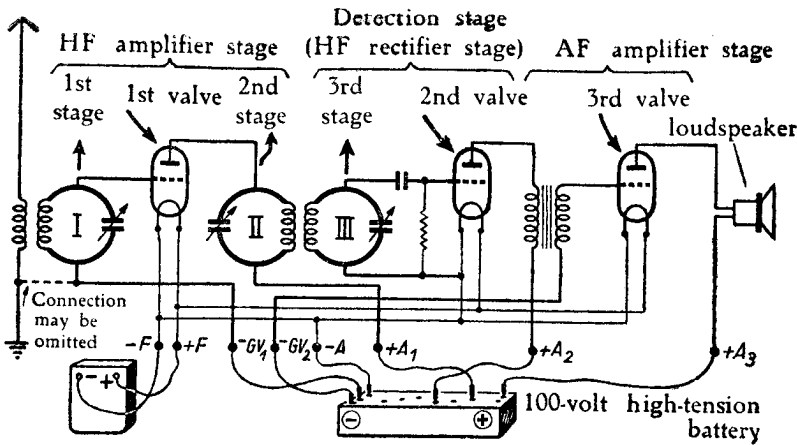

The complete circuit diagram of the three-stage receiver shown here will now be quite clear. (The circuit is represented in bare outline, since we will be able to go into details later.)

In regions where no mains supply is available, batteryfed receivers are used, with, however, a completely different circuit. The modern "superheterodyne" receiver, which will be discussed later, is generally used either with mains or with a battery supply.

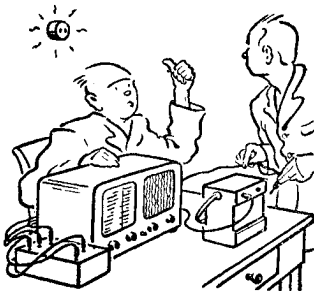

*"Why so complicated?
Try mains operation!"*

If the owner of such a receiver has a mains supply at his disposal, it is understandable that he would rather not operate the set on batteries. We will now see what can be done to make the set suitable for mains operation. Two important factors are involved: the heater supply of the tubes and the anode voltage supply. Both the filament battery and the high-tension battery can be readily eliminated.

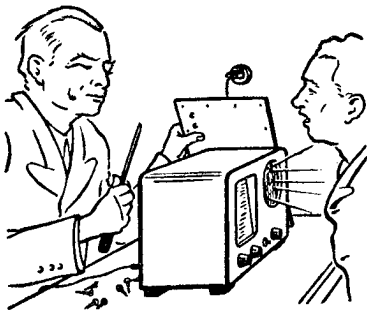

"No wonder this home-made radio receiver of yours hums. You used the wrong tubes."

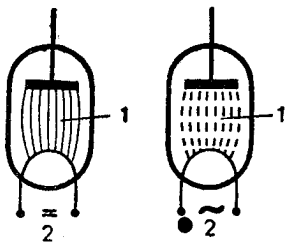

1 = uniform current of electrons.
 2 = A.C. filament supply.

1 = non-uniform current of electrons.
 2 = D.C. filament supply.

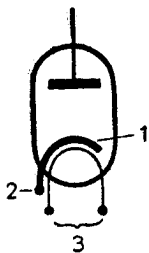

1 = indirectly heated tube with active layer. 2 = cathode connection. 3 = heater connections.

Let us assume that a 220-volt alternating-current mains supply is available. With the aid of a transformer (mains transformer) it would not be difficult to step down the high mains voltage to the 6.3 volts required for heating the tube filaments, but the use of alternating current for this purpose would unavoidably produce a serious hum in the loudspeaker, which cannot possibly be eliminated altogether.

The hum must be ascribed to the low frequency of the alternating-current mains, which with its 50 cycles per second is clearly audible. With direct current the filaments of the tubes are uniformly heated, resulting in a uniform flow of electrons from the cathode to the anode. With alternating current the temperature of the filament changes continuously, so that the emission of electrons is no longer uniform. The effect of this will naturally be noticeable throughout the set.

As previously stated in the section on rectifiers, radio engineers have solved this problem by placing around the insulated filament a small nickel tube coated with a thin layer of material which emits the electrons. The filament now only serves to heat the emissive layer and no longer emits the electrons itself. Tubes of this type are called "indirectly" heated tubes, as distinct from "directly" heated tubes, which are not equipped with a special cathode.

Choke coil with iron core (2)

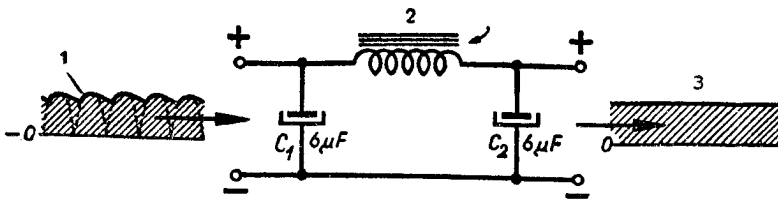

D.C. with ripple goes in (1), smoothed D.C. comes out (3).

The method of obtaining direct current for the anode circuit from the mains supply has been explained in the section on rectifiers. It was also stated there that the pulsating direct current can be further smoothed by means of a capacitor. In most cases, however, a capacitor alone will not be sufficient. For this reason the current from the rectifier is passed through a "smoothing unit" consisting of two capacitors C1 and C2 and a "choke" D. It is the task of this smoothing unit to remove all the impurities still present in the direct current. The object of capacitor C1 has already been explained. The choke prevents the passage of A.C. components and, should some of them slip through, there is still capacitor C2 to deal with them. Thus, pure and completely "smoothed" direct current is available at the output terminals (+ 2 — also at input!) (3).

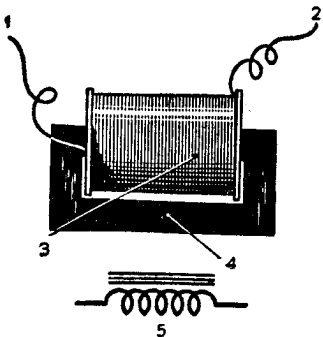

The choke consists of a large number of turns of insulated wire, that is, a coil, which in this case is provided with an iron core. In the graphical symbol the iron core is represented by a number of parallel lines.

1 and 2 = connections. 3 = winding. 4 = iron core. 5 = symbol for choke coil.

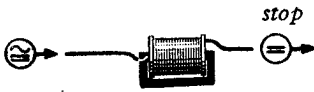

As its name implies, the coil has a “choking” action and in fact chokes the alternating current and allows the direct current to pass. Its efficiency depends on the number of turns and on the frequency of the alternating current involved.

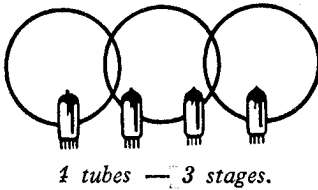

Armed with this basic knowledge, we should now be able at least in theory — and perhaps also in practice — to build a three-tube mains receiver. Inclusive of the rectifier tube (in the power pack) the set will be a four-tube, three-stage receiver. It should be pointed out, however, that a number of efficient receivers can be built with the same set of tubes.

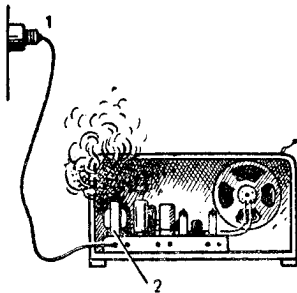

1 = mains socket with D.C.
2 = A.C. mains transformer.

Before we pass on to the more “advanced” theory of receivers, a few words should be devoted to the subject of A.C./D.C. receivers. The set that we have just discussed can only be used on an A.C. mains supply and if it were connected to a D.C. mains supply we would either blow the fuses, which are provided in most mains sets, or the mains transformer would get hotter and hotter, start to smoke and ultimately collapse.



1 = A.C. symbol. 2 = D.C. symbol. 3 = A.C./D.C.

As its name implies, the A.C./D.C. receiver can be connected to both A.C. and D.C. mains supplies. On factory-built sets this is indicated by means of a special sign, consisting of a horizontal line with the familiar sine-wave above it.

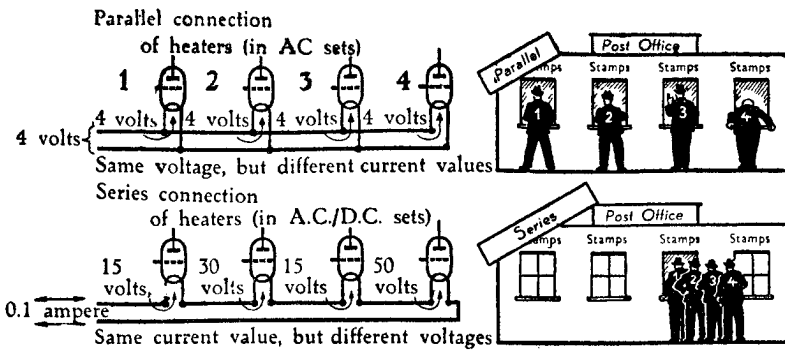

The power supply of A.C./D.C. receivers is arranged differently from that of A.C. sets. In the first place there is the supply of heating current to the tubes. Whereas the heaters of the tubes in an A.C. set are connected in "parallel", those in an A.C./D.C. set are connected in "series". In an A.C. set the parallel-connected heaters of the tubes all operate on the same voltage of 6.3 volts. In the case of the series-connected tubes of the A.C./D.C. receiver we are not so much concerned with the voltage of the individual heaters as with the current passing through them. The current should be the same for all heaters, for example 100 milliamperes. Yet it is quite possible that one tube is made for an operating voltage of 35 volts and another for 50 volts.

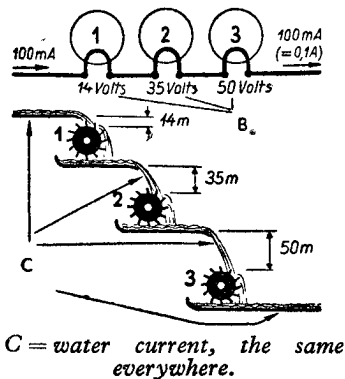

The "electrical" series arrangement can be compared with the "mechanical" series arrangement of a number of water wheels, of which the first, for example, operates with a smaller head of water (voltage) than the second, while the third operates with a still larger head of water. In all three cases, however, the water current is the same (just as the electric current is the same for any one of a number of tubes connected in series).

Heater circuit indicated by dotted line (see also below)

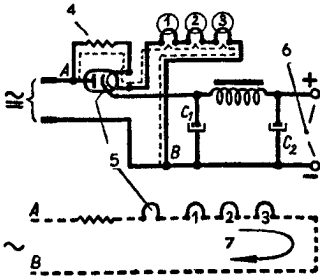

1, 2 and 3 = tubes with different voltages. 4 = series resistor. 5 = rectifier valve. 6 = anode voltage. 7 = heater circuit.
 C_1 and C_2 = capacitors.

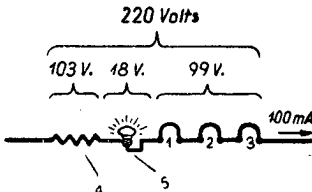

1, 2 and 3 = tubes. 4 = series resistor. 5 = dial light.

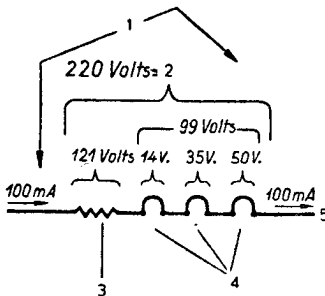

1 = heater circuit. 2 = mains supply of 220 V. 3 = series resistor or of 121 V. 4 = heaters of tubes. 5 = current voltage.

Let us assume that the three tubes require 14, 35 and 50 volts respectively, i.e. 99 volts in all. The mains supply, however, has a voltage of 220 volts. It is impossible, therefore, to connect the tubes directly to the mains, as they would burn out straight away. The problem is solved by the incorporation of a series resistance in the heater supply circuit, which reduces the voltage by 121 volts.

Most sets are equipped with dial lights which are likewise connected in series with the heater supply, provided, of course, their current consumption is also 100 milliamperes. In that case the value of the series resistor must be reduced accordingly, since allowance must be made for the voltage required by these lights.

The illustration on the left shows a simplified diagram of the heater circuit of an A.C./D.C. receiver. The direct current required is obtained by means of a rectifier tube (which can also be replaced by a metal rectifier). When the set is connected to a D.C. mains supply the rectifier tube does not function, but allows the mains current to pass (in one direction). The various types of tubes, their construction and their applications will be discussed later.

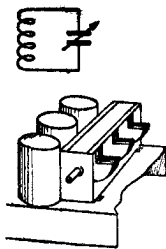

Receivers such as that shown on page 113 are now no longer used. To ensure adequate selectivity these so-called straight receivers should have at least three tuned circuits, as shown in the illustration. The disadvantage of this arrangement is that, with the tuning capacitor fully turned in, the selectivity is high but the sensitivity low, the reverse being the case with

the tuning capacitor fully turned out, viz. the selectivity then being low and the sensitivity high. Moreover, the three tuned circuits should be accurately aligned for any position of the tuning capacitor. With a receiver of this type short-wave reception is very difficult to achieve, if not impossible.

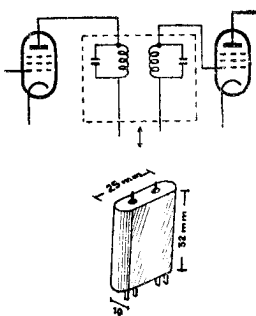

In modern receivers the HF amplifier is permanently tuned to a fixed wavelength, e.g. 645 m. For this one wavelength both the amplification and the selectivity are very good.

All wavelengths to be received are converted to this one wavelength. The amplifier is called an IF amplifier, i.e. "intermediate-frequency amplifier". It is of very compact design. Fixed capacitors are

employed and these are assembled together with the coils inside a screening can. The whole combination is called an "I.F. band-pass filter". The receivers are referred to as "superheterodyne receivers". Their sensitivity is very high, not only on long and medium waves but also on the short waves.

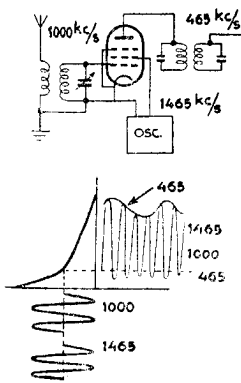

The wavelength conversion takes place as follows:

The receiver comprises a miniature transmitter, the so-called oscillator. The I.F. amplifier is tuned to 645 m, which corresponds to a frequency of $\frac{300,000}{645} = 465$ kc/s.

The oscillator is tuned to a frequency which differs by 465 kc/s from that of the signal to be received. In the example this signal has a frequency of 1,000 kc/s or 1 Mc/s. Thus the oscillator is tuned to 1,465 kc/s.

These two signals are "mixed" in the input tube. (In the example this is done by feeding the oscillator signal to the screen grid.) The adjustment of the tube should be such that rectification occurs. Apart from the original signals of 1,000 kc/s and 1,465 kc/s, two new signals (sidebands!) are present in the anode circuit of the tube, viz. one of 2,465 kc/s, the sum of the two frequencies, and one of 465 kc/s, the difference frequency.

Owing to the selectivity of the I.F. band-pass filter, only the last-mentioned signal is amplified (see also pages 76 and 77).

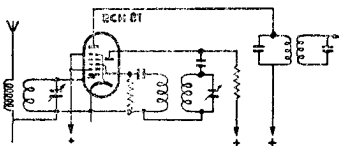

Usually a special mixer tube (frequency changer) is employed.

The tube comprises a triode section which serves as oscillator, while the other section is a heptode, i.e. a tube with five grids.

The first grid after the cathode is the control grid, which is con-

connected to the input circuit. The next grid is the screen grid, which screens the oscillator signal from the input circuit. This is followed by a third grid, which is connected to the oscillator grid. Next there is another screen grid, which has the same function as the screen grid in a pentode, and finally there is a fifth grid, which is a suppressor grid similar to that found in a pentode. The anode is connected to the first I.F. band-pass filter, which is followed by the I.F. amplifier tube. This circuit is found in all present-day (superheterodyne) receivers.

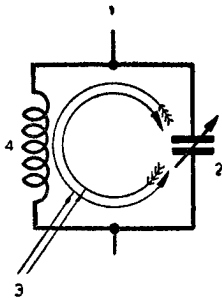

1 = electric currents flow to and fro. 2 = capacitor. 3 = electric oscillatory circuit. 4 = coil.

Let us now revert to the oscillatory or tuning circuits, which play such an important part in all receivers. In these circuits electric currents are in continuous oscillatory movement. The circuit consists of a coil, a capacitor and the wires connecting these components. The quality of a tuned circuit is dependent on the losses which occur in it.

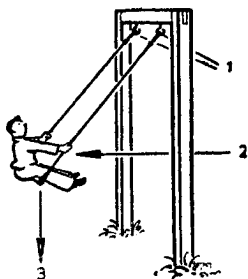

1 = friction losses. 2 = losses owing to air resistance. 3 = gravitational losses (force of gravity).

Losses also occur with mechanical oscillation. In the case of a swing, for example, losses are caused by friction of the suspension rings, air resistance and the force of gravity. If these losses could be completely eliminated, an ideal situation would result, since the swing would remain in perpetual motion without requiring additional energy from an external source.

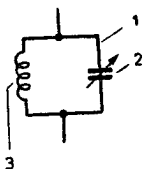

1 = losses by electrical resistance. 2 = losses in capacitor. 3 = coil losses. Losses must be reduced! Must use better coils!

In the electrical oscillatory circuit the losses are of a different nature. These losses are caused by electrical resistances which oppose the oscillating flow of the electric currents. In radio engineering special care is taken to reduce these losses, which have a "damping" effect, to an absolute minimum.

The total effect of all the losses in a tuned circuit is called the "damping" effect. Apart from by a suitable choice of components, the damping effect can be reduced by means of special circuit arrangements, such as the reaction circuit.

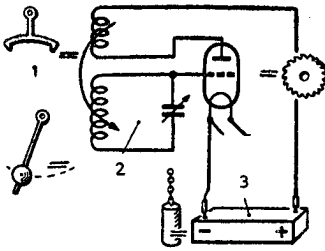

1 = reaction tube. 2 = oscillations.
3 = high-tension battery.
Anode current supply.

The reaction circuit can be compared with the mechanism of a pendulum clock. Once the pendulum has been set in motion, it will continue to swing to and fro. This is achieved by means of an "escapement" mechanism, which permits a toothed wheel to move on a little with each complete cycle of the pendulum. Each time the toothed wheel gives a slight push to the pendulum which is thus kept in continuous motion. The pendulum controls the unwinding of the clockwork and determines the frequency or the beat. The clockwork mechanism in turn furnishes the energy which the pendulum requires to keep on swinging. This mechanism, in which the movement of the pendulum is sustained by the clockwork, is an example of mechanical feedback or reaction.

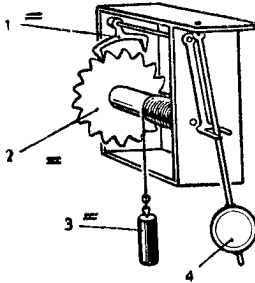

1 = anchor = reaction.
2 = gearwheel = tube.
3 = weight = anode current.
4 = supply oscillations of pendulum = electric oscillations in oscillatory circuit.

These visible mechanical oscillations correspond to the invisible electrical oscillations in the oscillatory circuit. The weight which keeps the clockwork mechanism going can be compared with the anode current supply. The intermediary between the driving power (weight) and the pendulum is the toothed wheel, just as the radio tube acts as the intermediary between the anode current supply and the oscillatory circuit.

As the grid circuit is very susceptible to small deviations, which can be troublesome with short-wave reception, the tuning capacitor of the oscillator should preferably be incorporated in the anode circuit. A disadvantage of

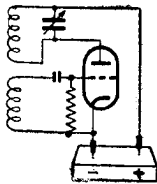

this arrangement is that the supply voltage is now on the frame, which should, if possible, be connected to the chassis.

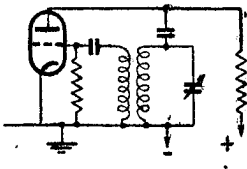

cathode via a resistor. Thus steady oscillation is achieved independent of the tuning. This is very important for good reception and the above circuit is therefore employed in all Philips receivers.

This can be arranged by connection of positive H.T. to the anode via a resistor, in which case the tuned circuit is connected to the anode via a capacitor. The grid is connected to the grid coil via a capacitor and to the

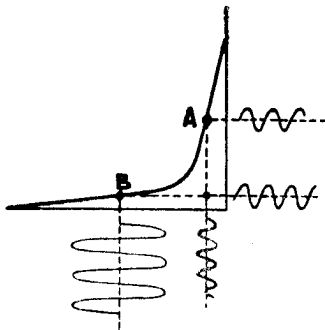

On page 107 we have seen what happens when a tube-characteristic is strongly curved. The signal produced is distorted. Something similar, as regards distortion, occurs when the signals become greater than that part of the characteristic which lies in the negative grid voltage range. To prevent the distortion of large signals use is made of tubes with a characteristic which flattens out considerably towards the end. These

tubes are called variable-mu pentodes.

For the reception of a weak signal the tube is made to operate at point A and for the reception of a strong signal at point B. It will be seen from the illustration that in both cases the changes in the anode current are about the same, which means that the same output signal is obtained for both strong and weak signals.

The "adjustment" of the correct grid voltage for each signal is effected by means of the A.G.C. How this functions will be explained later.

The I.F. amplifiers all function in the manner described.

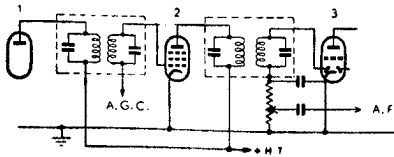

In order to understand fully the principles of the superheterodyne receiver it is important to study carefully the circuit diagrams shown here. The various stages and their functions will be described step by step, leading up to the complete circuit diagram of a simple receiver.

In this circuit diagram we see on the left the anode circuit of the frequency changer (1), followed by the first I.F. transformer

and the I.F. pentode (tube 2). The anode circuit of the latter tube includes another I.F. transformer. For the sake of convenience no details of the H.T. supply are shown, but the supply points are indicated by means of an arrow. One end of the secondary of the second I.F. transformer is connected to a diode, which forms part of another dual-purpose tube(3). This diode serves as detector for the I.F. signal. The earth side of the I.F. transformer is connected to the chassis via a potentiometer. This potentiometer serves as volume control. When the sliding contact is moved to the top of the potentiometer the volume is at its maximum, and with the contact at the bottom it is zero.

This end of the secondary winding is also connected to the cathode of tube 3 via a small capacitor.

The diode operates in exactly the same way as the crystal detector described on page 91. The I.F. signal which results after the wavelength conversion, contains the complete modulation which was present on the signal picked up by the aerial. The I.F. signal is detected in the diode and an A.F. voltage appears across the resistance of the potentiometer, while the I.F. remainder of the signal is passed to the cathode and to earth via the small capacitor.



The third tube shown in the above circuit diagram is a double-diode triode. As we have seen, one of the two diodes is used for detection. The other one is generally used for A.G.C. (automatic gain control). The triode is employed to amplify the weak A.F. signal present across the load resistor of the first diode, hence across the volume control in the circuit diagram.

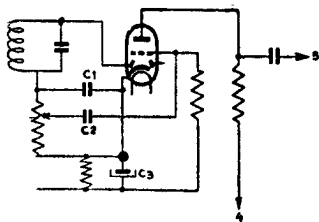

This is the complete circuit diagram of the A.F. amplifier, with all the necessary resistors and capacitors. We recognize the secondary of the second I.F. transformer and the diode detector. C_1 is the capacitor serving as a by-pass for the I.F. voltage. It will be seen that the cathode of the tube is connected to the chassis

via a resistor. The current through the tube creates a potential across this resistor, which furnishes the negative grid bias for the triode. As an audio-frequency alternating current also flows through the tube, the negative grid bias would fluctuate with

this signal, and for this reason an electrolytic capacitor is connected in parallel to this resistor. This capacitor by-passes the audio-frequency A.C. to the chassis, just as C_1 by-passes the I.F. signal. A capacitor of this type is called a by-pass capacitor.

The L.F. signal is now passed to the grid of the triode via C_2 . A direct connection cannot be made at this point, since the rectification of the I.F. signal causes a direct voltage across the load resistor of the diode. This direct voltage would give the triode an incorrect bias. In one of the next chapters it will be explained that a capacitor will pass alternating currents but no direct current.

The grid of the triode is connected to the chassis via a resistor. In actual fact the grid has no negative bias, but the cathode is positive with respect to the grid owing to the voltage drop across the resistor in the cathode line, which in fact amounts to the same thing.

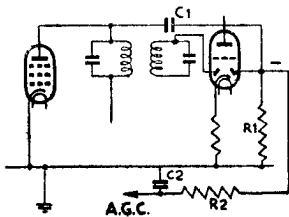

This circuit diagram explains how A.G.C. (automatic gain control) works. The first tube is the I.F. tube and is followed by the second I.F. band-pass filter. Also the double-diode triode is shown, although only the circuit of the second diode is included. This diode is connected to the anode of the I.F. pentode via a small capacitor. If this capacitor

were omitted the diode would receive the full supply voltage of this tube, which is not desirable. The diode is connected to the chassis via a resistor R_1 . The I.F. signal at the anode of the I.F. tube is rectified by the diode, the result being a negative potential at the diode, which is greater according as the signal strength is greater. However, the diode also acts as a detector and the rectified I.F. signal voltage must, therefore, first be smoothed (as in the case of rectified A.C. for the power supply) before it can be used as negative grid bias for the I.F. pentode and the frequency changer. In this case a choke is not required, but we use a resistor instead, which is indicated in the circuit diagram by R_2 . In addition, a smoothing capacitor (C_2) is required. The control voltage can now be applied to the two tubes mentioned. How this is done will be seen in the detailed description of the circuit diagram of a superheterodyne receiver. Frequently a single diode is used in superheterodyne receivers of simple design, which serves both for detection and A.G.C. In that case there is no connection to the anode of the I.F. pentode; the smoothing circuit, consisting of R_2 and C_2 , is connected to the top of the volume control.

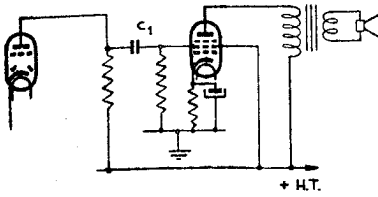

A description of the output stage is all that remains to complete the circuit of a simple superheterodyne receiver. At this stage, however, it should be pointed out that all Philips receivers, down to the simplest battery sets, are superheterodyne receivers. Hence, they can invariably be classed among the most sensitive receivers in their particular price range.

On the left in the circuit diagram we again see the double-diode triode. Only the resistor in the anode circuit is shown. Further, we see the coupling capacitor C_1 , through which the A.F. voltage across the anode resistor is passed to the grid of the output tube. This tube is again a pentode, but this time an output pentode. In the same manner as previously described the tube derives its positive cathode voltage from the voltage drop across the cathode resistor, which is de-coupled by means of an electrolytic capacitor. The screen grid of the output pentode is connected to the positive H.T. line. A transformer is provided in the anode circuit, its secondary being connected to the loudspeaker. This is done for the following reason. Output pentodes give their best performance with a load impedance of between 5,000 and 8,000 ohms. The impedance of the voice coil of the loudspeaker, however, is only 5 or 7 ohms. We must, therefore, use a step-down transformer to adjust the current that flows through the voice coil to the most favourable value, in the same way that the mains supply of 220 volts A.C. is stepped down to the 6.3 volts required for the heaters of radio tubes.

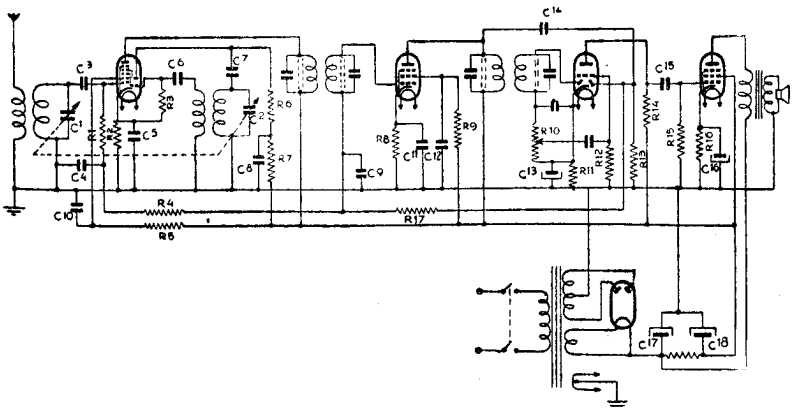

Here we have the complete basic circuit diagram of a superheterodyne receiver for operation on a 220-volt A.C. mains supply.

The circuit details of this superhet will, in principle, be encountered in all modern radio sets. There will, of course, be modifications dependent on the price of the set and on the type of supply employed (for example, A.C./D.C., dry-battery supply, etc.), but the basic circuit will invariably be recognized.

Everything we have so far discussed will be found in this circuit diagram. The aerial is inductively coupled to the grid coil of the frequency changer. The control grid is connected via capacitor C_3 , since the A.G.C. voltage is applied via R_1 . Without the capacitor C_3 this voltage would be short-circuited. The tuned oscillator coil is incorporated in the anode circuit of the triode. The grid is connected to the cathode via the grid leak R_3 in the manner previously discussed. The first I.F. transformer is incorporated in the anode circuit of the hexode section of the frequency changer. The secondary of this transformer is incorporated in the grid circuit of the I.F. pentode. The earth side of this coil is not connected to the chassis but to the A.G.C. voltage line. The smoothing of this voltage is effected by R_{17} and C_9 and by R_4 and C_4 . The screen grids of the frequency changer and the I.F. tubes receive their supply via series resistors, so as to ensure a lower voltage. These resistors are by-passed with capacitors, to avoid A.C. voltages on the screen grid.

The components in question are R_5 and C_{10} for the frequency changer and R_9 and C_{12} for the I.F. pentode.

The first diode of the double-diode triode is used for detection and is connected to the secondary of the second I.F. transformer as previously explained. The volume control R_{10} is not connected to the chassis but to the cathode, since a certain amount of direct current flows through the cathode resistor of this tube, which makes the cathode positive with respect to the chassis. If the volume control were connected to the chassis, the detection diode would acquire a negative bias with respect to the cathode. In that case only those signals whose voltage is much greater than the positive cathode voltage would be detected, while weak signals would either not be heard at all or be received with considerable distortion. This difficulty is avoided by direct connection of the volume control to the cathode, since without a signal the diode and the cathode are then at the same potential.

If the signals arriving at the second diode are weak they are not detected, because the load resistor R_{12} is connected to the chassis, so that in this case the diode is at a negative potential in relation to the cathode. The advantage of this is that with weak signals the grids of the frequency changer and the I.F. tube do not receive A.G.C. voltage. These tubes receive the necessary grid-bias voltage via their cathode resistors only and are, therefore, adjusted to maximum sensitivity. This explains why this superhet is so very sensitive to weak signals.

The grid of the triode section of the tube is connected to the volume control via a capacitor, in the manner previously described.

The output-tube circuit is identical with that already described. The secondary of the output transformer is earthed.

The power supply unit comprises a transformer and a full-wave rectifier. The choke has been omitted in the smoothing section, because the capacitance of modern electrolytic capacitors is so great that the anode voltage for the output tube can be taken straight from the input capacitor of the smoothing filter. All the other voltages are taken from the second capacitor of this filter. In this circuit the choke has been replaced by a wire-wound resistor. As a rule the two smoothing capacitors C_{17} and C_{18} are housed in a single aluminium container.

For the sake of simplicity the heater connections have been omitted in the circuit diagram. The heaters themselves, however, are shown in the tubes and the arrows indicate that they must be connected to the heater winding on the supply transformer. This transformer has a centre tap, which is usually earthed.

In A.C./D.C. receivers the heaters are connected as shown on p. 117. In receivers of this type the negative grid voltage is usually not obtained by means of cathode resistors but tapped from a common resistor in the negative H.T. supply line.

All refinements such as a "magic eye" for visual tuning indication, negative feedback in the L.F. amplifier to improve the quality of reproduction, etc., have been omitted in the circuit diagram shown. The inclusion of these circuit details would render the diagram too complicated; as it is the reader will require all his attention to understand it fully.

All Philips receivers are now equipped with negative feedback to improve quality of reproduction, and practically all the sets have an adjustable tone control. Moreover, the medium-priced and the more expensive sets are all equipped with a tuning indicator.

As stated before, all receivers can be split up into two sections, viz. the actual receiver section and the amplifier section. The "receiver section" delivers weak audio signals, which are considerably amplified in the amplifier section and finally converted into sound-waves by the loudspeaker.

The amplifier section of a receiver can be used for the reproduction of gramophone records, when the receiver section is not used.

The listener should switch his receiver to gramophone reproduction, so that the radio section of the set is cut out. The volume control of the receiver can then be used for the gramophone.

I: F.M. Reception

The early radio sets were only suitable for medium-wave and long-wave reception, but after some years had elapsed the larger sets were equipped with an additional short-wave range. However progress in radio engineering is fast and the advent of FM transmitters soon influenced the design of modern radio receivers. FM reception has numerous advantages. Apart from better reproduction, almost free from interference, its introduction in the sphere of broadcasting makes it possible to broadcast additional programmes and to avoid overcrowding of the existing wave bands. The FM waves have a shorter range than the longer waves in the other ranges. Generally speaking, the range of these waves is restricted to what is termed the "optical distance", i.e. as far as the eye can see.

It need hardly be pointed out that the range will increase if the transmitting and receiving aerials are higher. (See figure below.) Assuming that the transmitting aerial is 200 metres high, the waves radiated will have a radius of about 60 km. They can, however, also be received at a distance of 120 km, provided the receiving aerial at that point is also 200 metres high.

Height of the FM-dipole above ground level

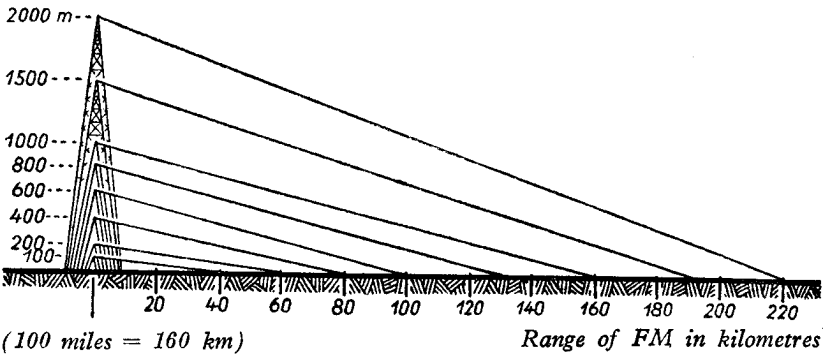

The above diagram shows the approximate range corresponding to each of a number of aerial heights.

It is true that the propagation of other types of waves also proceeds in a straight line, but short, medium and long waves are reflected by certain layers in the atmosphere, the ionosphere, and, under favourable conditions, can actually travel right round the earth. The essential difference between the transmission and reception of long, medium and short waves on the one hand and of FM waves on the other lies in the modulation (at the transmitter end) and the demodulation or detection (at the receiver end) of the radio

waves involved. The definition of "modulation" in radio engineering is "to superimpose the low-frequency audio waves on the high-frequency transmitter wave (carrier wave)". "Demodulation" or "detection" on the other hand is the removal of the same audio waves from the transmitter wave picked up by the receiving aerial.

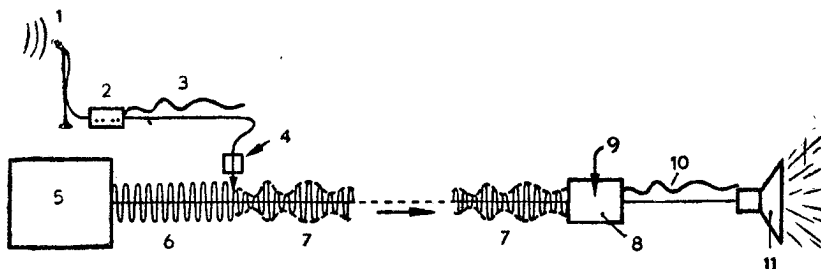

1 = microphone. 2 = amplifier. 3 = low-frequency oscillations (audio frequency). 4 = wave modulated here (modulated transmitting). 5 = wave factory. 6 = high-frequency transmitter wave. 7 = modulated transmitter wave. 8 = receiver. 9 = wave demodulated here. 10 = audio frequency. 11 = loudspeaker. 12 = sound.

The most commonly used type of modulation is "Amplitude Modulation" (abbr. AM). In FM broadcasting a different type of modulation is employed, viz. "Frequency Modulation" (abbr. FM). Some additional theoretical knowledge is required if one is to be able to distinguish between the two.

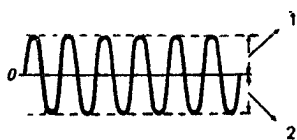

0 = zero line.
1 and 2 = amplitudes.

First of all, what is meant by "Amplitude"? The illustration on the left shows a uniform wave train with wave peaks and wave valleys. The amplitude of each wave is the distance between the zero line and the highest or lowest point.

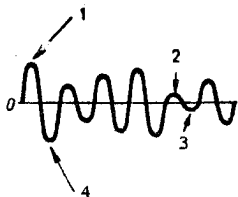

0 = zero line. 1 and 4 = large amplitudes. 2 and 3 = small amplitudes.

In the case of an irregular wave train, such as that shown here, there are both waves with a large amplitude and waves with a small amplitude.

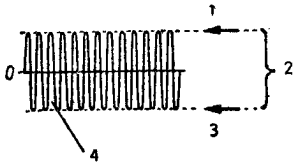

0 = zero line. 1 and 3 = uniform amplitudes. 2 = high-frequency wave train. 4 = high-frequency transmitter wave (unmodulated).

The broadcasting transmitters radiate high-frequency waves of uniform amplitude (high frequency wave train).

To avoid injustice to the laws of physics it should be added that on a long journey through the aether the transmitter waves become gradually weaker, and so the amplitude of the waves becomes gradually smaller. The radio engineer says that the waves are "damped", but we will not concern ourselves with this aspect here.

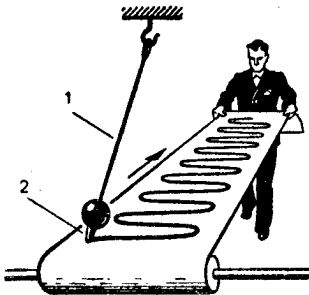

1 = pendulum. 2 = stylus.

A mechanical comparison will assist in explaining the process of modulation. If a stylus pen is attached to the lower end of a pendulum moving over a strip of paper travelling at a uniform speed, the movement of the pendulum will be recorded in the form of a wave train. (The electrical wave also moves to and fro, just like the mechanical pendulum.)

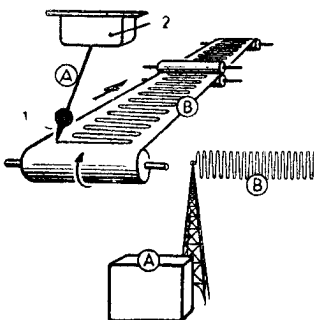

1 = stylus. 2 = oscillatory mechanism.

A special device at the top of the pendulum ensures that the pendulum swings at a steady rate (as is the case with pendulum clocks, for example). The strip of paper is propelled automatically. This mechanical pendulum illustrates quite well the functioning of our wave generator or transmitter.

(See A and B in illustrations.)

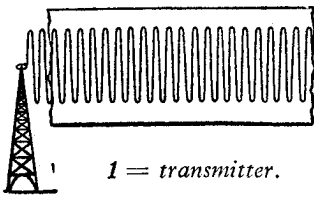

The illustration on the left shows what the wave pattern on the paper will look like. The recorded wave train has the same appearance as the high-frequency waves radiated by a transmitter.

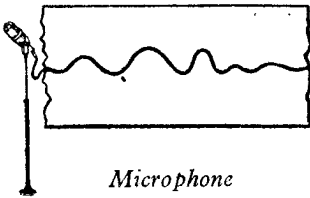

If we convert the sound waves striking the microphone into electrical waves and record them on a strip of paper, the result will be a train of slow, low-frequency waves, such as that shown in the drawing.

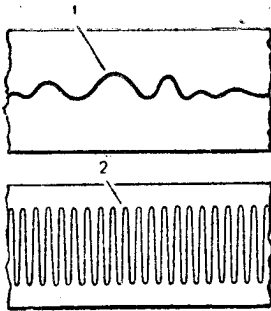

The sound waves (1) must influence the uniform transmitter waves or "carrier waves" (2).

It is the task of the transmitter engineer to send the sound waves in the form of electrical waves along with the "carrier wave" radiated by the transmitter, i.e. the uniform carrier wave must be influenced in such a way that it will take along the characteristic properties of the sound waves to be transmitted.

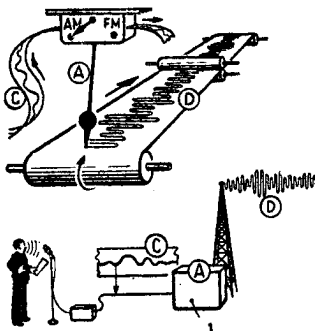

The regular waves transmitted by A will be influenced by the irregular waves of C. The result is D: amplitude modulation.

We shall now revert to the mechanical pendulum device. We could, for example, pass another strip of paper bearing a record of sound waves through the driving mechanism of the pendulum, so that the movement of the pendulum is influenced accordingly (just as the roll of music determines the tune of a pianola.) The stylus pen at the lower end of the pendulum will then record "modulated" waves, i.e. the original uniform wave train will be altered in shape, so as to conform to the pattern of the sound waves.

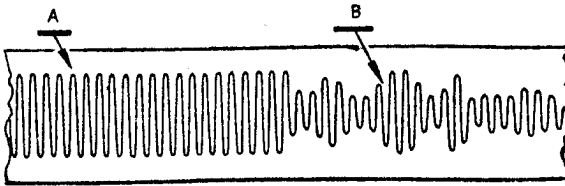

*A = before modulation. B = after modulation.
We call the result: Amplitude modulation.*

If the driving mechanism is set at “Amplitude Modulation”, it will cause the amplitude of the high-frequency waves to be modified in accordance with the low-frequency audio waves. As may be seen from the above drawing, the amplitude of the waves is no longer uniform. The waves have been forced to adapt themselves to the pattern of the sound waves.

If the driving mechanism of the pendulum is set at “Frequency Modulation” (FM), the amplitude of the waves is not affected and is, in fact, the same before and after modulation, but the frequency of the waves is changed in accordance with the sound waves.

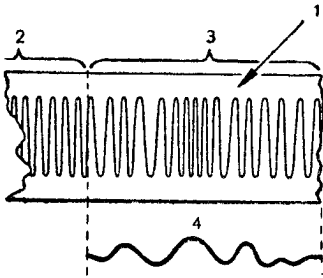

In the diagram the frequency-modulated carrier wave (transmitter wave) is shown on the right and it will be seen that the individual waves are now no longer uniformly spaced, i.e. some are closer together than others.

The difference between the two types of modulation will be clear from the two illustrations, in which only a small part of the sound wave in question is shown. In the case of AM it is the amplitude of the carrier wave that is changed and in the case of FM it is the frequency of the carrier wave, both in accordance with the rhythm of the amplified microphone currents.

The process of demodulation and rectification of amplitude modulated carrier waves in a receiver has already been discussed in brief in a previous chapter.

The conventional receiver circuit is not suitable for the reception of FM waves. For this reason provision has to be made in

AM/FM receivers for converting the frequency-modulated waves received into amplitude-modulated high-frequency waves. Apart from this the receiver functions in the "normal" way. Strictly speaking, the frequency modulation of the incoming wave is only used to "manufacture" a new amplitude modulated wave and is "completely ignored" by the demodulator.

Converter circuits of this type are called "discriminator" circuits. Further information will be given when the radio tubes are discussed in greater detail.

The modern all-glass tubes possess very favourable properties for FM reception. They undoubtedly constitute an important development in tube design. Not only are they considerably smaller than their predecessors, but also have better mechanical and electrical qualities owing to their special construction.

The all-glass tubes are not equipped with a separate base, so that the old trouble of the base coming away from the glass envelope no longer exists. The "seal" of the old type of tubes is no longer required, since the connections of the electrodes are passed direct through the glass base of the tube, which is fused together with the glass envelope.

By the 3-metre FM band is understood the wave range between 2.97 and 3.48 metres, in which all the FM stations are accommodated. The corresponding frequencies are 101 megacycles per second and 86 megacycles per second. One megacycle (Mc/s) is equivalent to one million cycles per second (c/s) and thus 100 megacycles per second represent 100 million cycles per second or 100,000 kilocycles per second (kc/s).

The sensitivity values will mean very little unless it is realized that a small value represents a high sensitivity. One millivolt is one thousandth part of a volt and one microvolt is a thousandth part of a mV or one millionth part of a volt. Thus, 5 mV represent five thousandths of a volt or 5,000 millionths of a volt, while 40 microvolts are equivalent to 40 millionths of a volt.

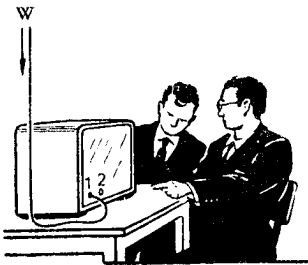

*W = wire coming from aerial.
1 = input connection of aerial,
where tensions of $20 \mu\text{V}$ are
measured.
2 = earth connection.*

The values used are very small, down to a millionth of a volt. Where do these small voltages occur? At the input connections of the receiver. It is the voltage of the high-frequency waves — the transmitter waves — that enter the receiver at this point.

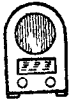

*Single-tube receiver
without reaction.
Sensitivity: approx.
10,000 μV .*



*Single-tube receiver
with reaction.
Sensitivity: approx.
1000 μV .*



*Two-tube receiver with
reaction. Sensitivity:
30—5 μV .*

When the radio engineer speaks of the sensitivity of a receiver he refers to the effective value of the input voltage which furnishes an audio power of 0.05 watts at the output terminals of the set. (When the sensitivity is measured certain other conditions must also be fulfilled.) We shall not go into details here, but the table on the left will give an idea of the sensitivity values of various receivers.

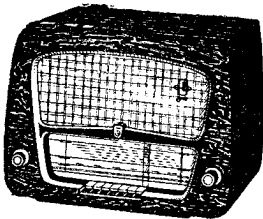

*Medium-grade radio set. Super
sensitivity: 10—4 μV .*

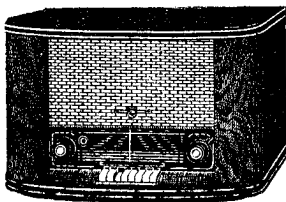

*High-grade radio set. Super sen-
sitivity: 5—1 μV .*

To sum up, it may be said that FM is much to be preferred to AM because it is much less susceptible to interference. Even in a thunderstorm FM broadcasts can be received without annoying atmospherics. This can be explained since thunderstorms are really strong amplitude-modulated signals. However, we are discussing here frequency-modulation receivers which, generally speaking do not react to amplitude modulation. Moreover, FM reception is free from interference caused by electrical equipment, since — like atmospherics — the waves generated are amplitude-modulated and a good FM receiver should not react to amplitude-modulated waves.

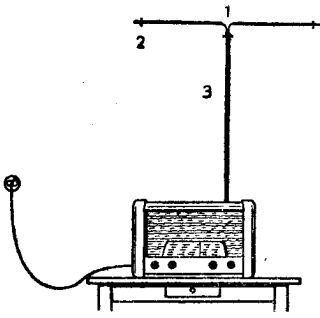

1 = dipole aerial. 2 = to be connected to the living-room wall.
3 = twin-core transmission line to the receiver.

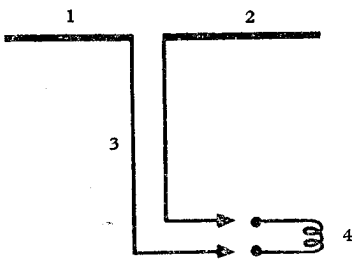

1 and 2 = two dipole halves.
3 = twin-core transmission lines.
4 = coupling input coil.



Indication for FM-dipole with twin core transmission line.

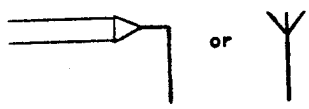

Indication for a conventional AM-aerial.

Receivers capable of FM reception require different types of aerials from those used with the existing AM wireless receivers.

In fact, a so-called dipole aerial can give much better reception results than conventional outdoor aerial.

The name dipole aerial can be explained, since it consists of two equal halves which are connected to a twin-core transmission line. (See figure at left.)

It has been mentioned before that one end of the aerial coil of a normal AM receiver is connected to the aerial and the other end to "earth". For FM reception a different aerial arrangement is usually required. In this case both ends of the aerial coil are connected to the transmission line leading to the aerial proper. Thus, the FM aerial has two poles, hence its name "dipole" (di = two).

It should be noted that the graphical symbol for a dipole (dipole aerial) is different from that of an ordinary aerial. It consists of two horizontal lines with two vertical lines indicating the transmission line.

A dipole aerial is only required to receive distant FM stations. More often than not the ordinary aerial, connected to one of the aerial sockets, will ensure satisfactory reception. The construction of a dipole aerial, however, is a simple matter.

First of all it is necessary to overcome the customer's aversion to a dipole aerial by explaining that even a special FM aerial is really a simple affair. All that is required is a length of ordinary twin-core "electrical" rubber-covered cable. Take one core in the right hand and the other in the left and split the cable over the required distance. Instead of cable, special 300-ohm twin lead can also be used and will give excellent results.

The total length of the two cores, which will later form the two horizontal elements of the dipole, should be equal to half the FM wavelength to be received. If the FM transmitter broadcasts on a wavelength of 3 metres, the total length of the two dipole arms should be 150 cm (i.e. each arm should be 75 cm long).

For an FM signal of 3 metres, 1. and 2. of the second drawing on page 133 should be approx. 75 cm each.

All that remains is to find a suitable place to mount the dipole, e.g. on the wall of the room.

At the other end of the cable the insulation is stripped from the cores for a distance of one cm and the bare wires provided with plugs, which are then placed in the aerial sockets of the receiver.

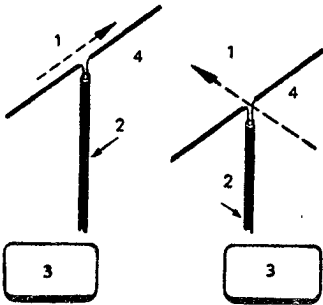

1 = direction to the FM station.
 2 = transmission line.
 3 = poor reception.
 4 = dipole.

1 = direction to the FM station.
 2 = transmission line.
 3 = excellent reception.
 4 = dipole.

As shown in the illustration, a dipole aerial has a directional effect, which means that its reception qualities are very good for waves coming from a specific direction. The sensitivity of the aerial is bad when the direction of the FM transmitter coincides with the longitudinal axis of the two arms of the dipole. The best results are obtained when the dipole is arranged at right angles to the direction of the transmitter. It is of the greatest importance, therefore, that the FM aerial should be correctly arranged in relation to the transmitter.

The correct position of a dipole aerial can be established quite simply if it is first fixed on a length of board, which is then held at different heights and in different positions until the best reception is obtained. It is quite possible that the ultimate position found differs from that originally assumed on the strength of the location of the transmitter. FM waves are often reflected, however, so that they may reach the aerial from a direction not corresponding to that of the transmitter.

In the immediate vicinity of the transmitter the reception conditions are not very critical. It will often suffice to place the split cable under the carpet, the correct position being found by trial and error.

If the dipole is of sufficiently rigid construction, it can also be fitted up in the open air, for instance outside a window, on a balcony or on the roof. The construction of suitable, insulated supports is a matter of individual skill and in the selection of materials for this purpose the effect of the weather should be taken into account.

The "attic aerial", a relic of the old days, gives good FM reception when arranged as a dipole. It can be freely suspended with string. As in the case of ordinary radio reception, the best results are obtained when the aerial is fitted as high as possible.

If the listener wishes to avoid all risks, he can of course order a ready-made aerial, a number of types of which are available.

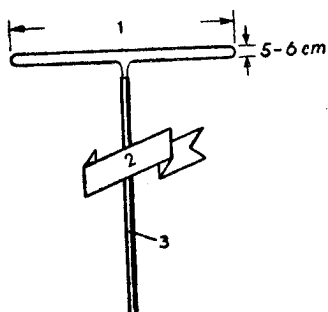

- 1 = half wave length.
- 2 = folded dipole.
- 3 = transmission line.

A customer may ask what a "folded dipole" or "loop aerial" is. He may have read something about this in a radio magazine. He should be told that this special type of FM aerial consists of an almost closed loop, of which the ends connect up with the transmission line. He should further be told that this arrangement does not give a louder reception than the simple dipole, but that it has other advantages. The advantages of a folded dipole are: 1. a more pronounced directional effect; 2. suitable for a wider range of frequencies; 3. more rigid construction.

In view of its rigid construction, the folded dipole is particularly suitable for mounting in the open air, for instance on the roof.

Another customer may tell you that he has heard of "reflector aerials" for FM reception, and he must be given an explanation. A reflector aerial consists of an ordinary dipole with a continuous metal rod mounted behind it (away from the transmitter) at a distance of one quarter wavelength (i.e. of 75 cm for a wavelength of three metres). This rod is mounted parallel to the dipole and has no connections. Its task is to reflect the incoming waves back on to the actual aerial like a mirror. This improves reception by about fifty per cent. The reflector should be a little longer than the dipole — about 5 per cent. For a dipole length of 150 cm the reflector should be between 157 and 158 cm.

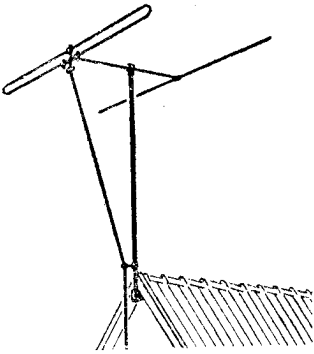

Folded dipole with reflector.



Not matched.



Perfectly matched.

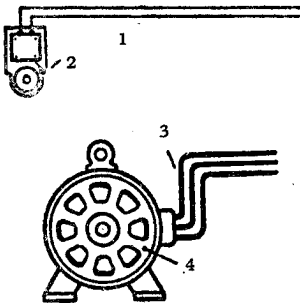

1 = thin wires. 2 = electric bell. 3 = a thick cable. 4 = electric motor. The cables are adapted to the working conditions.

A folded dipole can also be mounted in combination with a reflector. The illustration shows a folded dipole with reflector mounted on the ridge of a roof.

With ordinary radio sets very little attention is given to the "matching" of the aerial to the set, but for FM reception this is a very important point. It is essential that the FM aerial be matched to the receiver conditions, just as the size of a bed is matched to the person who is to sleep in it. (You cannot very well put an adult in a child's bed.)

Whenever optimum results are to be obtained, an effort will be made to achieve matched conditions. In the instrument maker's workshop, for example, the type of lighting will be adapted to the nature of the work. The temperature in a work space will also be adapted to suit the requirements of the work performed there. In engineering the size of water pipes, for example, is adapted to the volume of water to be transported through them, while conductors for electric current are adapted to suit the current densities involved (thin wires for electric bell circuits and thick cables for heavy motors, etc.).

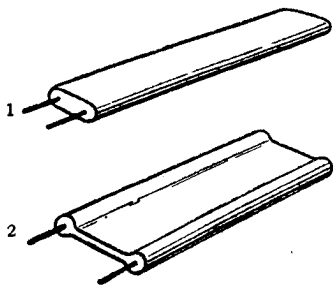

1 = twin-core transmission line (60 ohms). 2 = twin-core transmission line (300 ohms).

Formerly we were simply advised to use an ordinary twin-core cable as a transmission line, but theoretically this is incorrect, since a cable of this type has a much lower impedance, viz. of between 60 and 70 ohms. If a better match is required, so as to improve reception, a 300-ohm transmission line should be employed. Two single-core cables arranged at a small distance from each other can also be used as a makeshift, but special FM twin leads with different impedance values are commercially available and will naturally give better results.

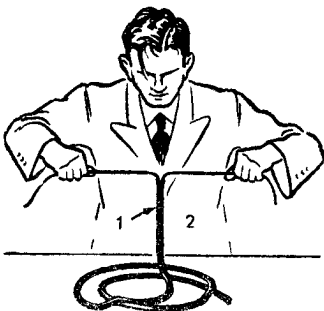

1 = twin core. 2 = rubber cable.

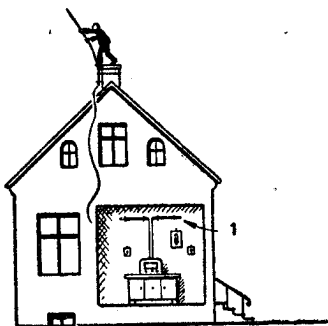

1 = small dipole.

To ensure that the aerial and the receiver are correctly matched, the characteristic "impedance" of the aerial transmission line must be the same as the input impedance of the receiver. The input impedance of all Philips AM/FM receivers is 300 ohms. Thus, whenever it is essential to reduce losses to a minimum, the impedance of the aerial transmission line must also be 300 ohms.

It would be wrong to advise the customer to do away with a roof aerial which has always given satisfactory service, if it is only to be replaced by an emergency FM dipole mounted on the wall in the room. When a dipole is to be used as a universal aerial, it should, of course, fulfil the most stringent requirements. In the first place it should be mounted as high as possible. (See picture on page 136.)

More often than not the ordinary aerial on the roof will give excellent FM reception of not too distant transmitters, so that a dipole aerial is not required at all.

Pick-up connection in modern wireless receivers

Pick-up connection.

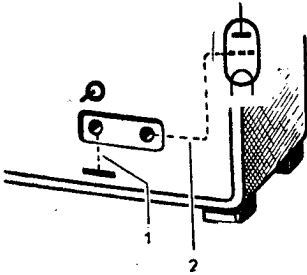

1 = connected to metal chassis inside. 2 = connected to grid of amplifier tube inside.

Most receivers are equipped with a pick-up connection at the rear of the set. One of the two sockets is permanently connected to the chassis in A.C.-sets, while the other is connected to the grid of the amplifier tube.

The first socket is completely "dead". When the set is switched to "gram", this socket can be touched with the finger without producing a sound from the loud-speaker. The other socket, however, is "live" (figuratively speaking, of course) and, when touched with the finger, will cause the loud-speaker to emit a loud hum.

Construction of screened cable

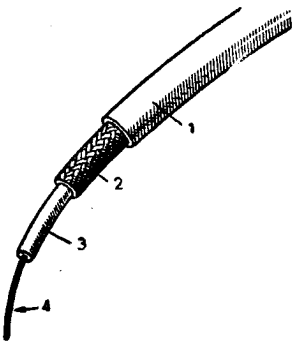

1 = outer insulation. 2 = metal screen (connected to chassis).
3 = insulation covering.
4 = conductor.

Naturally, the wires connected to the socket are also "live" and very susceptible to undesirable influences. For this reason they are covered with a metal "screen", consisting of wire braiding, which is connected to the chassis.

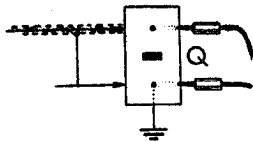
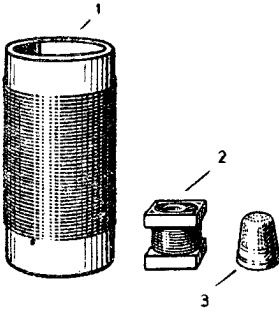

Illustration of a pick-up connection.

The wire connecting the pick-up to the sockets on the receiver is also "screened" with metal braiding. In circuit diagrams the "screening" is clearly indicated by marking of the wires in question with the special symbol shown in the illustration.

J: Coils and inductance



1 = old type of coil (cylindrical coil). 2 = modern coil (dust-core coil). 3 = thimble shown for comparison of size.

Coils, such as those employed in tuning circuits, are no longer manufactured in the simple cylindrical form with which we have so far become acquainted. This type of coil is now completely out of date and has been replaced by smaller but more efficient units. There are so many types that we cannot discuss them all here, but instead we shall devote some attention to the fundamental principles of coils.

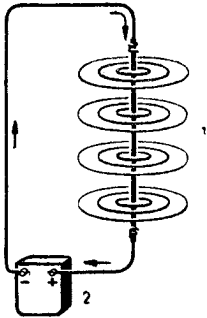

1 = electromagnetic field. 2 = battery.

When a current passes through a wire, an “electromagnetic field” will be set up around it. The magnetic lines of force take the form of concentric circles at right angles to the wire and become weaker and weaker as the distance to the wire is increased. In the accompanying illustration the magnetic field is shown in a number of planes.

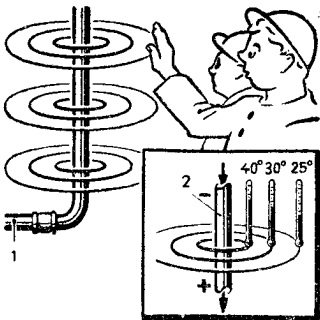

1 = central-heating pipe. 2 = pipe with hot water.

The expression “electromagnetic field” will be clear when this field is compared with the heat radiating from a central-heating pipe. Unlike the “electromagnetic field”, which we cannot perceive with our senses, the “field of heat” round the pipe can be perceived with the aid of our sense of touch.

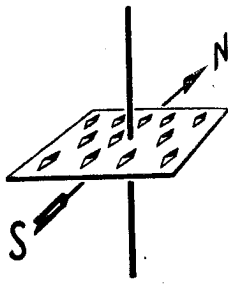

The presence of an electromagnetic field can be established with the aid of small compass needles. To show this we pass a cardboard disc over the wire, on which we arrange a number of compass needles. As long as no current passes through the wire, the north poles of these needles will point north.

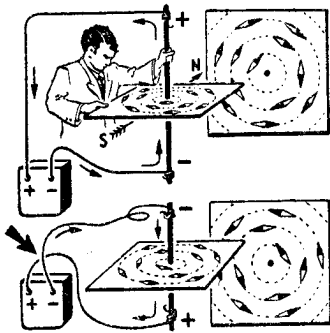

If we pass a direct current through the wire, the needles will rearrange themselves in a circle. They have been influenced by an invisible force radiating from the current-carrying wire. This force must be a magnetic force; otherwise it would not affect the magnetic needles. It has resulted from the flow of electric current and is simply an electromagnetic force which acts in a field round the wire.

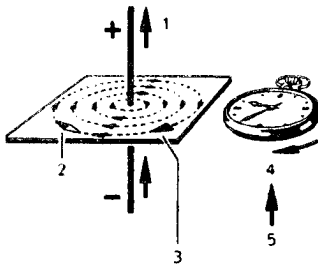

1 = direction of current. 2 = magnetic pointer. 3 = direction of flux lines (clockwise) with current flowing upwards. 4 = direction of rotation. 5 = hand is driven from below.

The current of the DC supply flows from the negative pole to the positive pole (electron current.) Armed with this knowledge it will not be difficult for us to establish the course of the electromagnetic field, which can be done with the aid of a watch. Let us assume that the current affecting the needles flows up the wire, just as the hand of the watch next to it is driven by the mechanism below it. The course of the lines of force will then be in the same direction as the movement of the watch hand. The north pole of a compass needle placed in the field will be forced to turn in the same direction.



If the wire is wound in a coil and current is passed through it, the individual lines of force round the wire will build up a strong electromagnetic field inside the coil, resulting in a north pole at one end and a south pole at the other end of the coil.

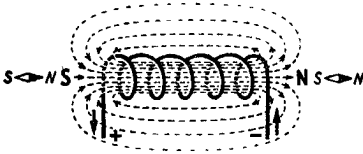

This can be easily proved with the aid of a compass needle. The electromagnetic field thus formed resembles the magnetic field of a bar magnet.

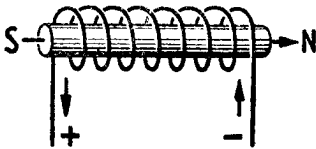
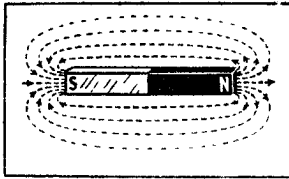

The electromagnetic field can be made still stronger by the introduction of an iron core into the coil. The iron absorbs the lines of force and itself becomes a magnet (electromagnetism).

Cross-section of dust-core coil.

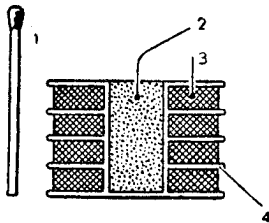

1 = match shown, to compare size. 2 = dust core. 3 = winding. 4 = insulation.

In the case of the coils in the tuning circuits of our receivers it is an essential requirement that a strong electromagnetic field be created, and for this reason the coils are equipped with an iron core. It prevents losses caused by the lines of force "straying" outside the coil and, in fact, keeps them together. If a solid iron core were used, other losses would occur, viz. eddy-current losses. For this reason the iron core is moulded from very fine iron powder to which a binding agent has been added. In this way the losses referred to above are avoided. The coil itself is divided into a number of sections, and the result is a high-grade circuit component. The radio engineer speaks of "dust-core coils".

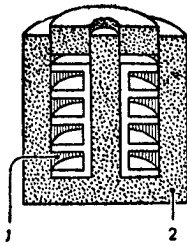

1 = space for winding. 2 = dust core.

If the coil is, moreover, surrounded by a moulding of the same iron powder material, all possible radiation and stray fields will be completely eliminated. All other electrical conditions being equal, the iron-core coil requires fewer turns of wire than the old cylindrical coil.

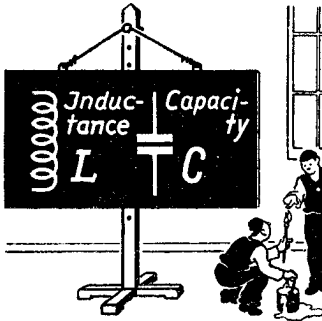

Inductance
L

Capacity
C

The characteristic electrical value of a capacitor is its "capacitance", while in the case of a coil we speak of its "inductance". In formulae inductance is represented by the letter L, just as the letter C stands for the capacitance of a capacitor.

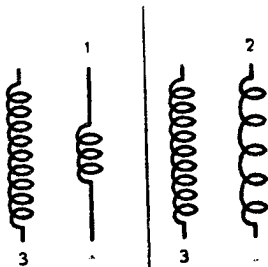

1 = fewer turns give smaller inductance than 3.

2 = turns spaced wider give smaller inductance too.

A coil with a large number of turns has a larger "inductance" than a coil of the same type with a smaller number of turns. The value of the inductance is further determined by the diameter of the coil and the spacing of the turns. The inductance will be smaller according as the spacing is wider. The value of inductance is expressed in henrys (H), while small values are expressed in millihenrys (mH).



Direct current: right of way!

Coils and capacitors have entirely opposite properties. Whereas a capacitor constitutes an insurmountable barrier for direct current, a coil will allow direct current to pass without any difficulty.

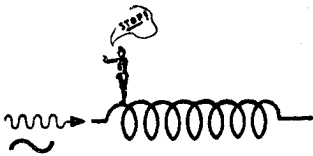

Alternating current: Stop!

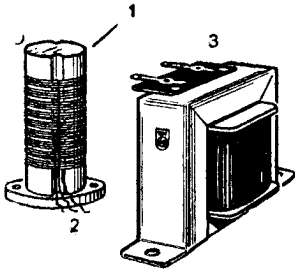

1 = HF choke with iron core (2).
3 = LF choke with dust core.

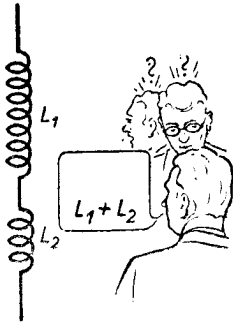

*Total inductance? With "series-connection" this is simple:
 $L_1 + L_2$.*

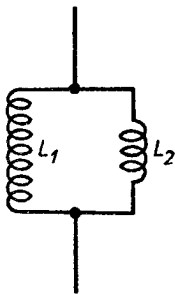

With "parallel-connection" total inductance is smaller than L_2 . (L_2 is smaller than L_1 .)

The resistance which a coil offers to alternating current will be greater according as the inductance of the coil and the frequency of the current are higher.

Coils can, therefore, be used for choking alternating currents and in that case they are called choke coils. The design of these chokes may vary, dependent on whether they are used for high-frequency or for low-frequency currents.

As the inductance of a coil increases with the number of turns, the total inductance of two series-connected coils equals the sum of the inductances of the two individual coils. (Exactly the opposite is the case with the capacitance of two series-connected capacitors.)

The total inductance of coils connected in parallel is smaller than the inductance of the smallest coil and here again the opposite is the case with the capacitance of parallel capacitors.

K: Capacitors and Capacitance

Comparative capacitance

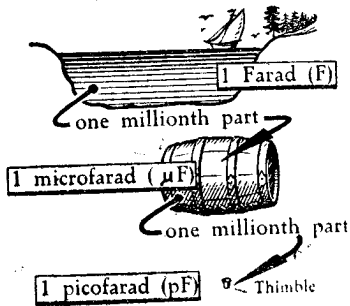

The basic principles of capacitors have already been discussed in a previous chapter (see page 70), but a little additional information concerning these important components will prove useful. Apart from the larger types of capacitors, whose capacitance is measured in microfarads, there are also smaller types with capacitances expressed in picofarads (abbr. pF). The picofarad is one millionth part of a microfarad and one billionth part of a farad.

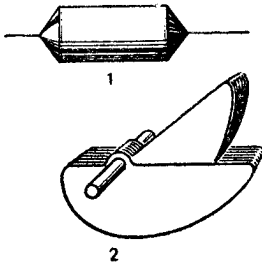

1 = fixed capacitor, so capacitance not variable, e.g. 2 microfarads ($2 \mu F$). 2 = variable capacitor so capacitance variable, e.g. between 40 and 400 microfarads (μF).

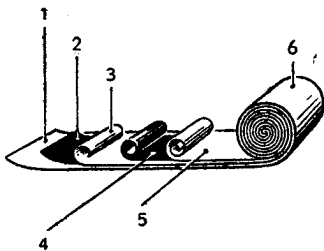

1, 3 and 5 = paper impregnated with paraffin wax. 2 and 4 = aluminium foil. 6 = roll.

Capacitors are classified in two main groups, those with a fixed capacitance (fixed capacitors) and those of which the capacitance can be varied. The principal members of the latter category are the so-called variable capacitors, about which more later.

We shall first of all study the construction of the fixed capacitors. As stated before, the electrical capacitance of a capacitor is determined, inter alia, by the area of the metal plates mounted opposite to each other and by the distance between them. Capacitors with high capacitance values will, therefore, take up a lot of space. Hence, a different construction will have to be used in practice. The paper capacitor, for example, consists of two strips of aluminium foil insulated from each other by a strip of paper impregnated with paraffin wax. Further strips of paper are placed on the outside of the strips of aluminium foil, and the various layers are then made into a tight roll.

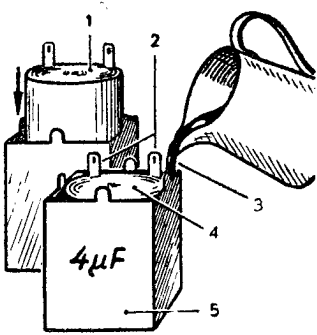

1 = roll. 2 = connections. 3 = filling-compound. 4 = roll. 5 = metal container.

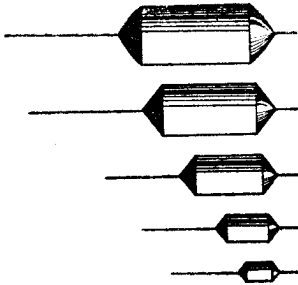

Capacitors in metal containers.

The roll, with two connections protruding from it, is then placed in a metal container and the remaining space filled up with paraffin wax. The container is closed by means of a small cover plate.

In this way it is possible to construct capacitors of very high capacitance, since the distance between the two layers of metal is very small (equivalent to the thickness of the paper), while the aluminium strips may be of considerable length.

The standard capacitors of this type have a fixed capacitance ranging from 1,000 pF to 0.5 μ F. The insulating intermediate layer — in this case the impregnated paper — is referred to as the “dielectric”.

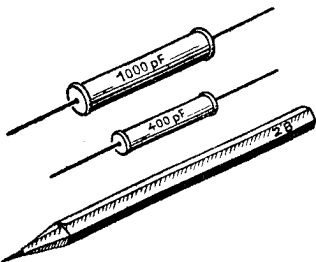

Rolled-block capacitors.

Another type is the so-called rolled-block capacitor, which is manufactured in a range of low capacitance values and fulfils a large number of duties in radio receivers. As regards construction it is similar to the paper capacitor previously discussed, and the dielectric used may be paper, mica or even plastics, dependent on the electrical requirements.

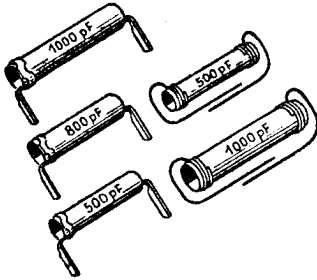

Tubular capacitors.

in tubular form, with ceramic material employed as dielectric. A correct choice of ceramic material will permit the capacity and the properties of the capacitors to be controlled within wide limits. The metallic layers of the capacitors consist of silver which is baked on to the ceramic material. The capacitance of this type of capacitor is, therefore, very constant and ranges from about 3 to about 10,000 pF. They are obtainable with either soldering tags or wire connections.

The capacitors of the types discussed so far cannot be used in all applications, since for high frequency purposes, for example, special capacitors must be employed. These capacitors should be of the low-loss variety, and temperature-compensated, while their capacitance should be accurate to very close tolerances. Moreover, they must be small. The capacitors which fulfil these requirements are usually manufactured

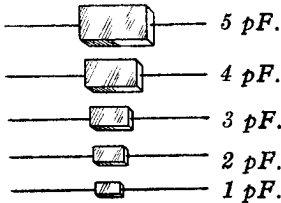

Cube capacitors.

The so-called cube capacitors are manufactured in very small capacities ranging from 1 to 5 pF and in this case, too, ceramic material is used as dielectric. Capacitors are available in all sizes and shapes, but their performance is based on the same principle.

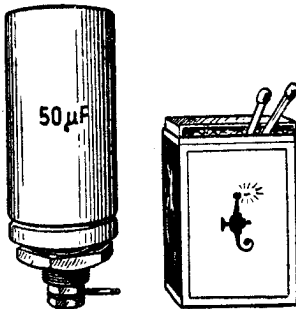

Electrolytic capacitor.

The "electrolytic capacitors" are of a different type altogether. They are housed in a metal container of relatively small dimensions and yet the capacitance may be as high as 1000 μF. One connection is insulated and brought out at one end, while the other is the aluminium container itself.

Construction of an electrolytic capacitor.

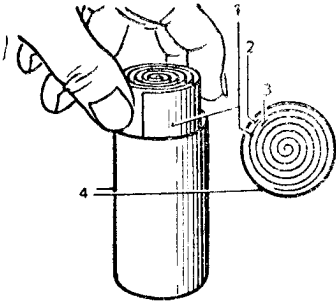

1 = spiral of aluminium foil.
2 = layer I (electrolyte). 3 = layer II. 4 = can.

It has been stated before that the closer the two metal layers are together, the greater will be the capacitance of a capacitor. In the case of the electrolytic capacitor this condition has been fulfilled in a very ingenious manner. A roll of aluminium foil is simply placed in an aluminium container and constitutes one of the layers. The container is then filled with a current-conducting solution of a salt (electrolyte). A very thin layer of oxide is formed on the aluminium and it is this layer which constitutes the dielectric. In this way the distance between the two layers is reduced to an absolute minimum.

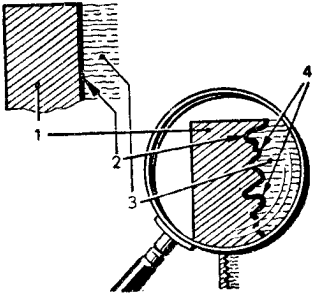

1 = aluminium. 2 = layer of oxide. 3 = electrolytic fluid. 4 = enlarged surface through roughening.

In addition, the surface of the aluminium foil is roughened so as to make the effective area as large as possible. This explains why it is possible to achieve such high capacitances despite the relatively small size of the capacitor.

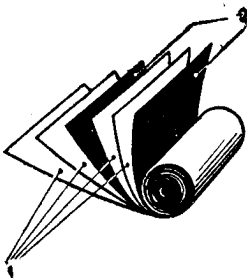

1 = paper as carrier for electrolyte. 2 = aluminium foil.

This wet type of electrolytic capacitor is hardly used nowadays and preference is given to the semi-wet type. The construction of the latter is similar to that of the paper capacitor, and absorbent paper is employed as a carrier for the electrolyte.

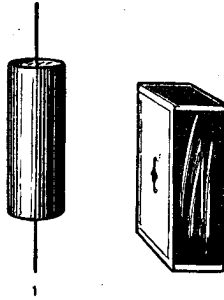

This type is (incorrectly) called the "dry" electrolytic capacitor. The capacitor proper is housed in a protective cardboard container and has a wire connection at either end.

1 = dry electrolytic capacitor.

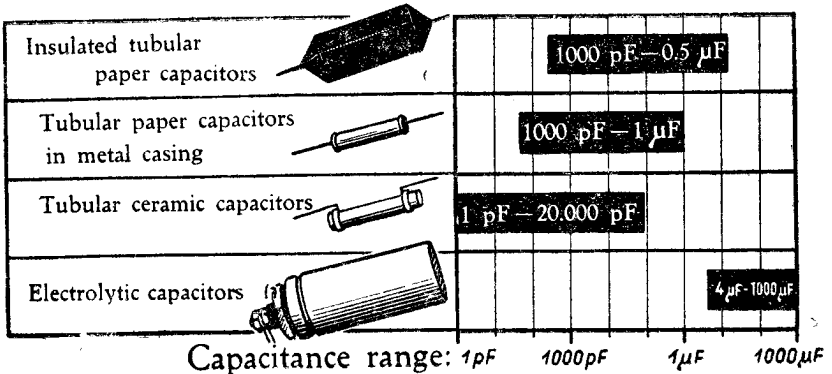

The above diagram give an impression of the capacity ranges of the various types of capacitors.



Symbol for electrolytic capacitor.

In the case of "polarized" electrolytic capacitors the positive and the negative terminals must not be confused. There are also "non-polarized" electrolytic capacitors which may be connected either way, as there is no "polarity" to be observed. In circuit diagrams the two types are indicated as shown in the illustration.

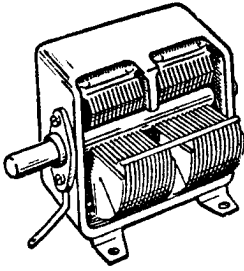

Two-gang variable capacitor (air dielectric).

outer plates of the rotor are slotted, which facilitates adjustment when a number of capacitors are mounted on a single shaft the sectors of the slotted plates then being bent.

It is true that variable capacitors, with a dielectric other than air, (e.g. mica, presspahn, polystyrene, etc.) take up less space, but they involve greater losses. They are only used, therefore, in places where this is not a serious disadvantage.

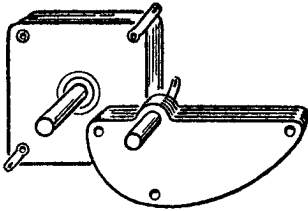

Variable mica capacitors (dielectric: mica).

There is yet another type of capacitor of which the capacitance can be varied, viz. the trimmer. It has a very small capacitance and is used for "aligning" tuned circuits, in which case it provides a small additional capacitance in the circuit in which it is incorporated. Once they have been adjusted to the correct value these capacitors are left. Trimmers may take the form of small ceramic discs coated on one side with a baked-on conductive layer. The capacitance of these ceramic trimmers can, therefore, be varied in the same way as that of a variable capacitor.

Trimmer

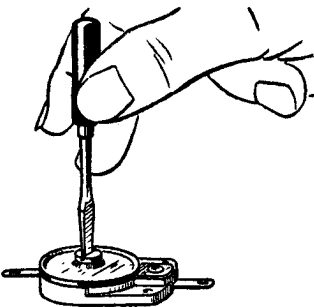

Adjusted once with the aid of a screwdriver.

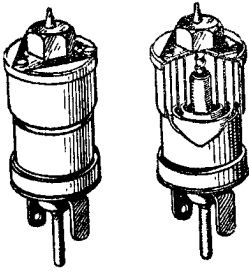

Air trimmer.

The low-loss air trimmer shown in the illustration is a Philips product. The two metallic surfaces are formed by a number of concentric tubes, of which one set can be screwed into the other without making contact. The top part of the capacitor is mounted on a threaded spindle and the extent to which it is screwed down into the lower part determines the capacitance.

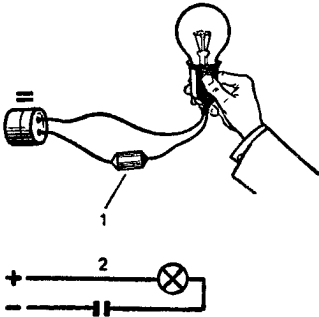

1 = capacitor. 2 = diagram of the above circuit.
Lamp does not light up!

Capacitors do not permit the passage of direct current. A capacitor included in a D.C. circuit will prevent the flow of current, irrespective of how high its capacitance may be.

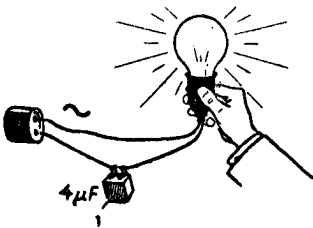

1 = alternating-current capacitor.

If the experiment is repeated with an A.C. mains supply, it will be seen that the lamp in the circuit lights up in spite of the presence of the capacitor.

With direct current.

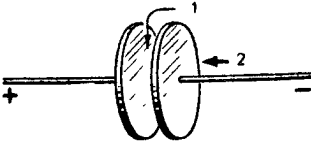

1 = dielectric. 2 = no current flow tension.

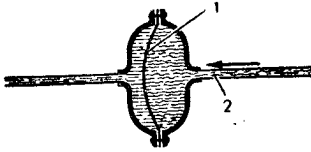

Cross-section.
1 = rubber diaphragm (dielectric).
2 = water current.

With alternating current.

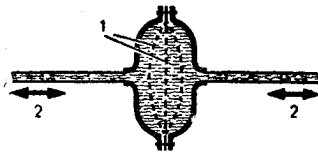

1 = rubber diaphragm swings to and fro. 2 = flow with alternating current.

The result might give the impression that capacitors pass alternating current, which in actual fact is not the case at all. This will immediately be clear if, for the sake of comparison, we replace the capacitor by a vessel with a rubber diaphragm, on the general lines shown in the drawing. When the water current flows in one direction only (direct current) the diaphragm is forced outwards, whereupon all movement stops. The water in the pipes ceases to flow.

When an alternating current is passed through the line the situation is quite different. The alternating movement of water is sustained despite the presence of the rubber diaphragm, which moves backward and forward in the same rhythm as the alternating water current.

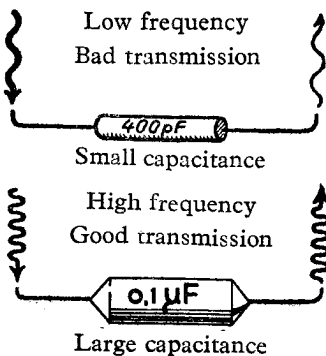

The greater the capacitance of the capacitor, the better the transmission of alternating current. The frequency of the current also plays a part, since with low frequencies the transmission of current is not so good as with high frequencies.

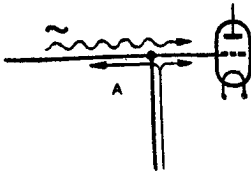

A = D.C. voltage should not go to left part of circuit, but to grid.

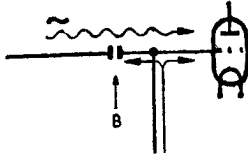

B = no entry for D.C. voltage.

In radio engineering frequent use is made of the fact that capacitors are capable of transmitting alternating current and form a barrier for direct current. Sometimes it is necessary to apply, for example, an A.C. signal and a direct current to the grid of a tube simultaneously, but the D.C. should not get on to the line with the A.C. signal (on the left in the illustration). The problem is solved simply by blocking of the path for the D.C. with the aid of a small capacitor.

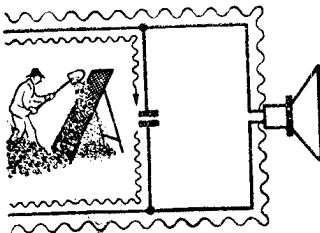

In another case it may be desirable to separate low-frequency current from high-frequency current. The low-frequency component should pass through a loudspeaker, while the high-frequency component must be side-tracked. This is achieved by connecting a capacitor in parallel with the loudspeaker. The two components of the current are then separated as shown in the illustration.

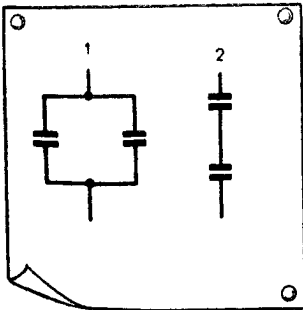

1 = two capacitors connected "in parallel" give increased capacitance. 2 = two capacitors connected "in series" give reduced capacitance.

When two capacitors are to be used in combination, they can be connected either in "parallel" or in "series". The total capacitance is different in each case.

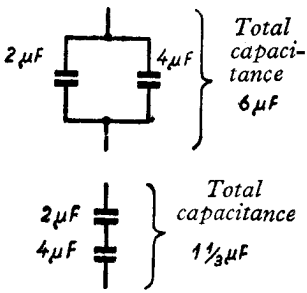

When the capacitors are connected in parallel, the total capacity is equivalent to the sum of the capacitances of the individual capacitors. When they are connected in series, the total capacitance is invariably less than that of the smaller capacitor.

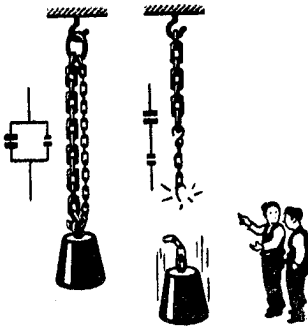

This can be easily remembered with the aid of the following comparison. When two chains are made into a double chain by their being placed side by side (in parallel), the total strength will be greater than that of the individual chains, irrespective of whether one is stronger than the other. On the other hand, when a weak and a strong chain are connected "in series", the strength of the new chain thus obtained will be equivalent to that of the weakest part. (In the case of series connected capacitors the total value even smaller.)

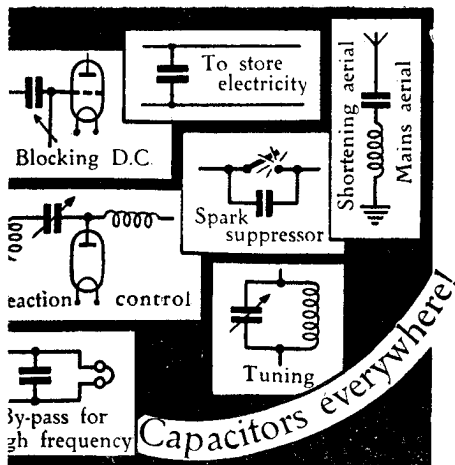



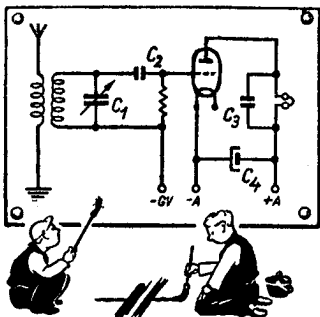



Capacitors have a wide range of applications. They are used for storing electricity, for smoothing voltages and currents, and for blocking direct currents when these occur simultaneously with alternating voltages. Together with coils they play an important part in tuning circuits. They are used to adjust feedback or reaction, for separating high and low frequencies, for changing the timbre in audio circuits, as interference suppressors in electrical equipment, etc.



In formulae and circuit diagrams capacitors are indicated by the letter C (C_1 , C_2 , C_3 , etc.).

There are four capacitors in this circuit.

Capacitors 	Coils 
Capacity C measured in: farads (F) microfarads (μ F) picofarads (pF)	Inductance L measured in: henrys (H) millihenrys (mH) microhenrys (μ H)
D.C.: No entry! A.C.: Right of way!	A.C.: No entry! D.C.: Right of way!
 $C = \frac{C_1 \cdot C_2}{C_1 + C_2}$  $C = C_1 + C_2$	 $L = L_1 + L_2$  $L = \frac{L_1 \cdot L_2}{L_1 + L_2}$

This table contains the characteristic data of capacitors and coils.

L: The necessity of bandspread for the short-wave ranges of overseas receivers

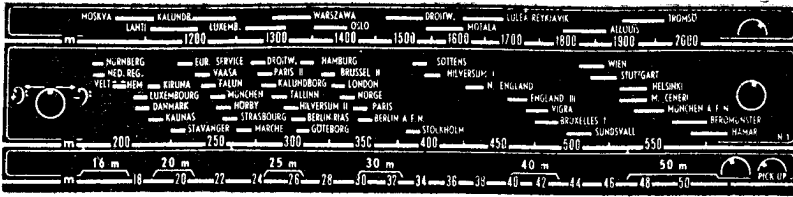

An example of European dial with station names, and without bandspread in the SW-range (16—50 m.)

Receivers intended for reception in overseas territories are, as a rule, not equipped with a long-wave range, i.e. the range from 750 to 2,000 metres. Even in the early days of radio it was found that the long waves (LW) were quite useless in these territories, owing to atmospheric interference. For this reason LW transmitters are found only in Europe and in Russia.

What is the position as regards medium waves (MW)? Transmitter surveys in respect of MW stations in the Middle East, the Far East, Africa and Central and South America have shown that powerful MW stations, such as are encountered in Europe (120 kW stations), are unknown there. Particularly in the Far East and in the greater part of Africa 10-kW medium-wave stations are actually considered very powerful. Quite a number of MW stations operate with an aerial power of 1 or 2 kW or even less! Consequently, they are only of local importance. Moreover, the medium waves are also affected by atmospherics (though to a lesser degree), which often spoils reception completely.

Furthermore, the relatively small radius of MW stations is usually quite inadequate to cover the vast areas involved.

Short-wave (SW) transmissions, on the other hand, are less affected by atmospherics and have a much larger radius.

On the strength of the foregoing the three wave ranges can be classified in the order of their importance for overseas areas as follows:

- SW — very useful
- MW — useful over small areas
- LW — useless in the tropics

MW-situation versus SW-situation

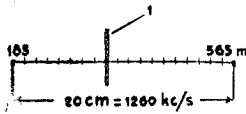

1 = tuning indicator.

We will now compare the frequency ranges of the MW and SW bands.

The frequency range of the MW band is approximately as follows: $185-565 \text{ m} = 1780 - 520 \text{ kc/s}$ or a frequency range of 1,260 kc/s.

Thus, when we shift the station pointer of our receiver from one end of the scale to the other we tune through the whole of this frequency range.

Assuming that the scale length of a medium-priced receiver is 20 cm (8"), it will be clear that this distance represents a frequency range of 1,260 kc/s.

In practice this means that when the pointer is shifted one millimetre the resulting frequency variation will be 6.3 kc/s. When it is remembered that two stations should officially be 9 kc/s apart, it follows that the pointer must be shifted as much as 1 to $1\frac{1}{2}$ mm before the second station appears. Anyone who has tuned a receiver on the MW band will know from experience that this is a simple matter, since the tuning-knob rotation required to shift the pointer over a distance of 1 to $\frac{1}{2}$ mm is quite large. Even with the smallest MW receivers the listener will not experience any undue difficulties in tuning in to the desired MW station.

On the short-wave bands the situation is quite different. In the first place it should be pointed out that there are eight internationally recognized SW-broadcast bands, viz. the 11, 13, 16, 20, 25, 30, 40 and 50 m bands.

The majority of SW stations have been allotted carrier frequencies in these bands, but there are also SW broadcast stations outside these bands. Hence, if a manufacturer wishes to offer full SW reception his receiver should include a SW range of approximately from 11 to 50 metres, which corresponds to a frequency range of $27,200 - 6,000 \text{ kc/s} = 21,200 \text{ kc/s}$.

Again assuming a scale length of 20 cm (8"), a simple calculation will show that one millimetre pointer-travel corresponds to a frequency variation of 106 kc/s. It will be clear that with the same transmission ratio between tuning knob and pointer it will be very difficult to tune in to the desired SW station unless special measures are taken, since 1 mm pointer-travel may cover $106/9 =$ roughly 12 SW stations!

This tuning difficulty is not a very serious drawback in receivers for European countries, where strong MW signals, and frequently very stable LW signals as well, are available.

In actual fact numerous listeners in Europe seldom tune in to SW stations and for this reason only the higher-priced European models are equipped with bandspread on SW. In overseas territories, how-

ever, many listeners are largely or solely dependent on SW reception, and some attention should therefore be given to the feature of bandspread.

Bandspread

In the first place it should be pointed out that bandspread can be achieved in a number of different ways. However, Philips have always aimed at combining bandspread with *continuous* SW coverage, since, as has been stated, there are also SW stations which operate outside the international SW-broadcast bands.

The simplest method of achieving bandspread is to split up the SW frequencies into a number of different ranges, as shown below:

Example I	Example II
11 — 17 m	11 — 17 m
17 — 30 m	17 — 26 m
30 — 93 m	21 — 32 m
	32 — 65 m

The subdivision of the SW range is determined by the electrical values of the variable capacitors and of the tuning and oscillator coils.

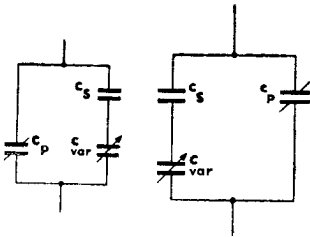

Further band magnification on the different SW bands can be realised by means of adjustable and fixed series and parallel capacitors in the aerial and oscillator circuits. C_p = a trimmer (parallel capacitor) of 30 pF, which can be adjusted on the production line. C_s is a fixed series-capacitor. C_{var} is the variable capacitor, which is operated by the tuning knob.

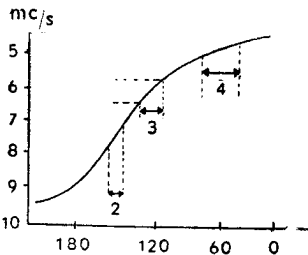

Example of a wave range of 32—65 m.

It should be appreciated that a number of variations are possible in the circuits shown. The capacitor C_s in these circuits ensures a flat tuning curve. Such a tuning curve is shown here.

Even with higher-priced and de-luxe receivers it is often found that the tuning facilities on the official SW-broadcast bands are still not adequate. For this reason it will be useful to discuss three practical methods, whereby the tuning on SW, which is so important for long-distance reception of often weak signals, can be still further improved.

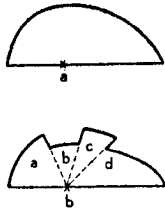

The illustration on the left shows a normal capacitor plate (a) together with a capacitor plate of special design (b). We have seen in previous chapters, in which the capacitor was discussed, that in any position of a variable capacitor its capacitance is proportional to the surface area of the plates covering each other.

When we rotate the tuning knob of a capacitor with normal plates the capacitance is varied gradually. In the case of the variable capacitor with plates of special design the capacitance varies rather slowly for sections b and d, since rotation of the tuning knob will result in only a slight increase or decrease in capacitance. The dimensions of these plates have been so chosen that in the wave range, from 13.3 to 19.9 m, for example, the sections b and d coincide exactly with the 16 m and 20 m bands.

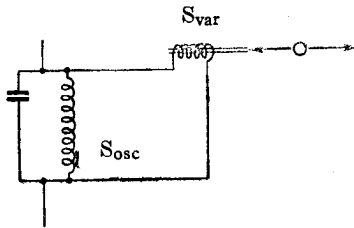

Another possibility is to incorporate a second tuning device in the SW oscillator circuit. This circuit is shown in the illustration where S_{osc} is the oscillator coil. A coil S_{var} is connected in parallel with the oscillator coil and provides an additional means of tuning, since the inductance of this coil

can be varied by moving an iron core into or out of the coil with the aid of a small knob. The inductance of S_{var} is quite small compared with that of S_{osc} , thus permitting slight variations to be made in the inductance.

A further refinement, which is only incorporated in de-luxe models, is a very large transmission ratio between the additional fine-tuning knob and the movement of the iron core in S_{var} .

Besides affording ease of tuning on SW, the use of a dipole aerial will greatly improve the reception of weak SW signals. The Philips dipole aerial, type 7320-10, is very suitable for this purpose, especially when its directional effect is used to full advantage, as shown in the illustration.

This aerial has been specially designed for SW reception, and if the listener has a preference for a specific SW band the aerial can be tuned to this band. The table below shows the lengths of the dipole elements for a number of SW bands.

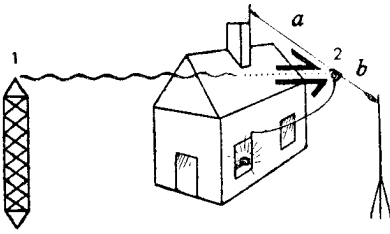

16 m band	4 + 4 m
20 m "	5 + 5 m
25 m "	$6\frac{1}{4} + 6\frac{1}{4}$ m
30 m "	$7\frac{1}{2} + 7\frac{1}{2}$ m

4 + 4 metres	($13\frac{1}{8} + 13\frac{1}{8}$ feet)
5 + 5 "	($16\frac{1}{2} + 16\frac{1}{2}$ ")
$6\frac{1}{4} + 6\frac{1}{4}$ "	($20\frac{5}{8} + 20\frac{5}{8}$ ")
$7\frac{1}{2} + 7\frac{1}{2}$ "	($24\frac{3}{4} + 24\frac{3}{4}$ ")

Thus, if reception on the 16-m band is preferred, the elements *a* and *b* shown in the illustration should each have a length of 4 metres.

M: Sound distribution in our homes with the aid of the A.C. receivers

It is generally known that excellent record reproduction can be obtained with the aid of the AF amplifier section of a wireless set. It is not so generally known that intercommunication can be achieved in a simple manner with the aid of a small inexpensive unit, viz. the interphone AF 7800.

The interphone can be easily installed on the inside of the rear panel. The switching device and the matching transformer incorporated in this unit provide the following five possibilities of intercommunication and sound reproduction:

I. Radio-phone switch in the P.U. position.

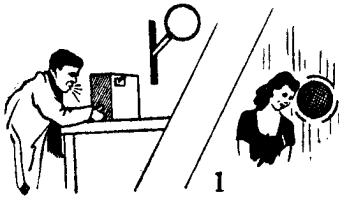

a. With the handle in the top position (1) the listener can speak to his wife.

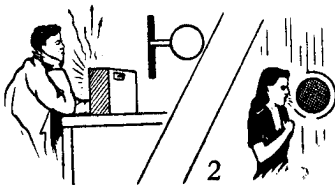

b. With the handle in the central position (2) she can answer her husband.

II. Radio-phone switch in the radio position

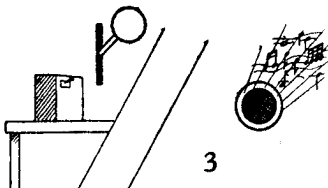

The following three possibilities are provided with the interphone handle in the top, central and bottom positions, respectively:

a. Radio reception on the extension loudspeaker (3).

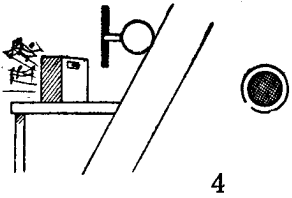

b. Radio reception on the loudspeaker of the receiver (4).

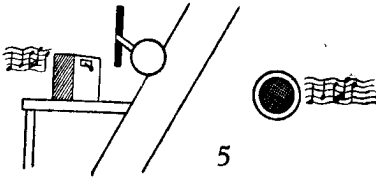

c. Radio reception on both loudspeakers (5).

With the Radio-phone switch in the P.U. position and the interphone handle in the top position the circuit is as follows:

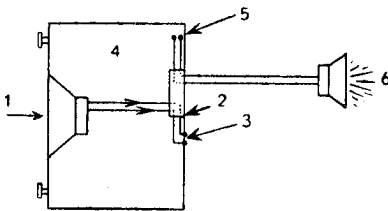

1. Receiver loudspeaker (which functions as a microphone)
2. Matching transformer
3. P.U. sockets
4. AF section of the receiver
5. Secondary winding of the loudspeaker transformer
6. Extension loudspeaker.

With the Radio-phone switch in the P.U. position and the interphone handle in the central position the circuit is as follows:

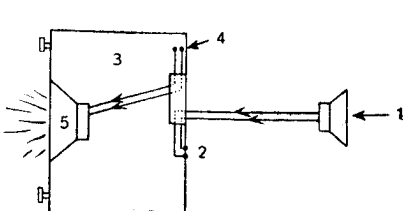

1. Extension loudspeaker (functions as a microphone)
2. P.U. sockets (through matching transformer of the interphone)
3. AF section of the receiver
4. Secondary winding of the loudspeaker transformer
5. Receiver loudspeaker.

CHAPTER THREE: SOUND IN ALL ITS FORMS

A: From microphone via amplifier to loudspeaker



1 = microphone.

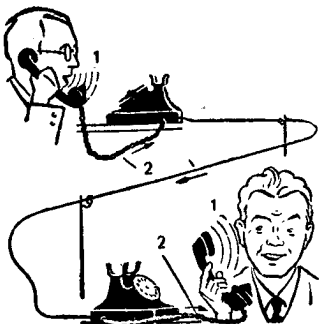

1 = sound. 2 = current.



A microphone is a fairly familiar piece of equipment, since it is encountered almost everywhere and can in fact be found in every telephone set.

When one speaks into the microphone of a telephone set, the spoken word travels along a wire to the subscriber called. It is not, of course, the actual sound that travels along the wire, but the electric currents representing it.

In any case, it all starts with the microphone. Its task is to convert sound and its waves into corresponding electric currents. At the other end of the wire a second instrument converts the fluctuating electric currents back into sound. As an illustration of what happens, imagine a length of hose through which flows a steady stream of water. When the hose is pressed slightly between finger and thumb, the stream of water will not attain full strength. As soon as the pressure on the hose is reduced more water will flow from it.

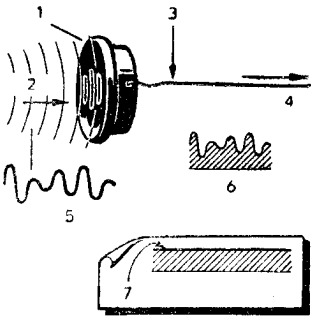

1 = microphone. 2 = sound.
 3 = line. 4 = current flows here.
 5 = sound waves. 6 = current
 influenced by microphone.
 7 = unaffected current.

Just as the steady flow of current can be influenced by varying the resistance which it has to overcome, it is also possible to vary a steady flow of electric current. A microphone (in a telephone set, for example) can be usefully employed to influence the flow of current in the line to which it is connected.

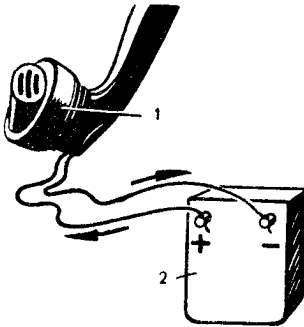

1 = microphone inside casing.
 2 = battery.

The drawing shows a microphone such as may be found in an ordinary telephone handset. It is connected to a battery, which furnishes a steady supply of current.

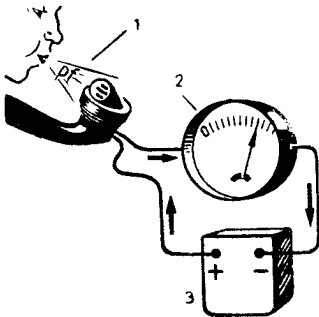

1 = microphone (inside).
 2 = measuring instrument.
 3 = battery.

If a sensitive measuring instrument is incorporated in the circuit it will be seen that this instrument indicates a small steady flow of current, since the microphone constitutes a resistance in the circuit.

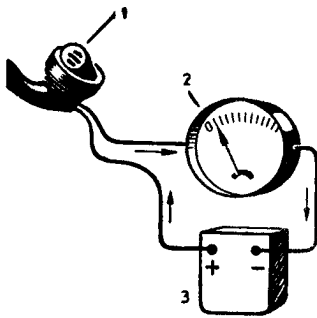

1 = one blows gently in microphone. 2 = measuring instrument. 3 = battery.

Sound waves strike the microphone.

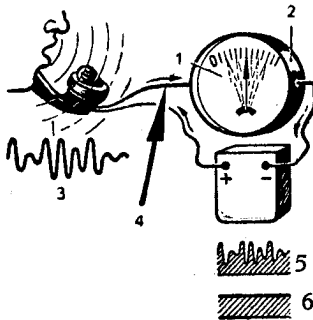

1 = pointer vibrates. 2 = measuring instrument. 3 = sound waves. 4 and 5 = electric current influenced by sound waves. 6 = how the current looked previously.

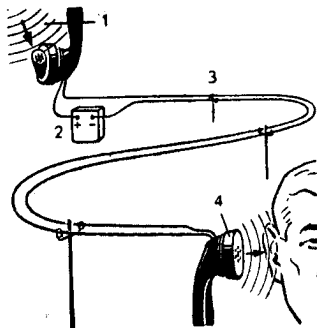

1 = sound. 2 = battery. 3 = long-distance line. 4 = telephone.

When one blows gently into the microphone the pointer of the measuring instrument will deflect, which means that the current conditions in the microphone circuit have changed. The air pressure has reduced the resistance of the microphone, so that more current can flow.

If, instead of the steady air pressure caused by blowing, sound waves strike the microphone, these waves will influence the current conditions in the microphone circuit in the same way. In fact, the microphone imposes the rhythm of the sound waves on the flow of electric current, which is then subject to the same fluctuations as the air in front of the microphone.

The arrangement shown above only serves to illustrate the physical principles involved. In a practical telephone installation it is essential, of course, that the electric currents created be converted back into sound. This is done with the aid of a sound-reproducing instrument, which is connected in the same way as the measuring instrument, but at the end of a longer line.

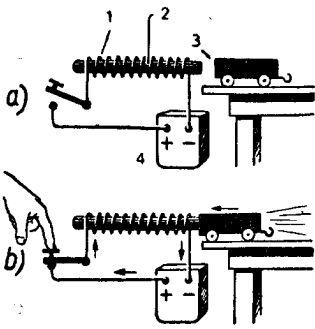

1 = insulated wire. 2 = iron bar.
 3 = iron wagon. 4 = battery.
 a) circuit open: wagon is not attracted.
 b) circuit closed: wagon is attracted.

To be able to understand how this instrument works we must go into some detail. If an insulated wire is wound round an iron bar and a current is passed through the wire, the bar becomes magnetic. The stronger the current, the greater the magnetic power of the bar. This arrangement is called an "electromagnet".

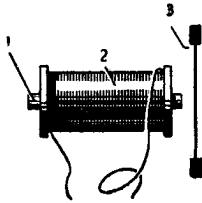

1 = iron core. 2 = coil.
 3 = iron diaphragm.

The small iron wagon shown in the illustration above is now replaced by a thin iron diaphragm, which is mounted at a small distance from one of the "poles" of the electromagnet. The experimental wire on the bar is likewise replaced by a coil consisting of a large number of turns.

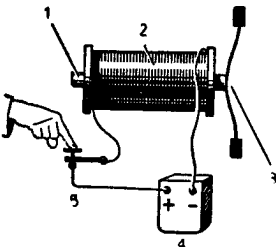

Diaphragm is attracted as soon as switch is closed.
 1 = iron core. 2 = coil.
 3 = diaphragm is attracted.
 4 = battery. 5 = circuit closed.

When current is passed through the coil, the diaphragm is attracted by the electromagnet. As the diaphragm is fixed at the rim, it will bend inwards towards the iron core and will return to its normal position when the flow of current is interrupted.

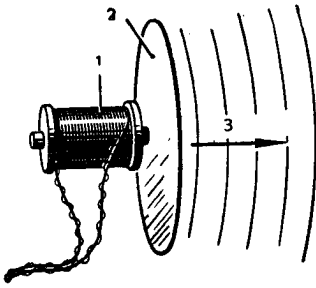

1 = electromagnet.
2 = diaphragm. 3 = sound waves.

If this coil is included in the microphone circuit in place of the measuring instrument previously shown, the microphone currents will pass through it. The density of the currents varies in accordance with the rhythm of the sound waves, so that the diaphragm is attracted to a greater or lesser extent in accordance with the current fluctuations. The diaphragm in turn transmits its movements to the surrounding air, resulting in audible sound waves, which correspond to those caused in front of the microphone.

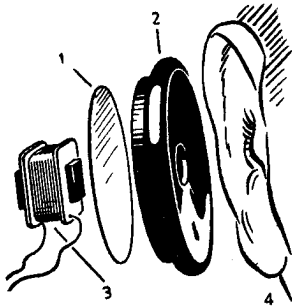

1 = diaphragm. 2 = earpiece.
3 = electromagnet. 4 = ear.

The electromagnet in a telephone receiver of this type is actually quite small. The diaphragm is protected by a bakelite earpiece.

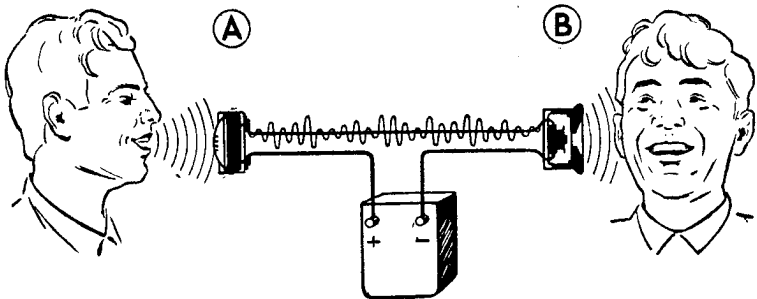

A = microphone. B = distant telephone.

The illustration shows a simple diagrammatic representation of a (one-way) telephone circuit. The sound waves at A are converted into current fluctuations by the microphone and the resulting currents travel along the line to the "receiver" at B, where they are converted back into sound waves.

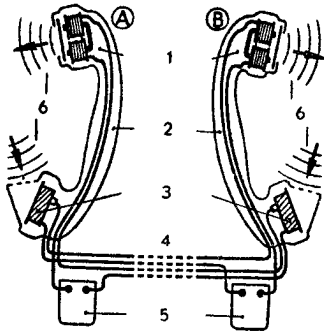

1 = telephones. 2 = handset.
3 = microphones. 4 = current.
5 = batteries. 6 = sound.

The normal handsets of a telephone comprise both a microphone and a receiver, so that it is possible to speak and listen at both ends (at A and B). The construction and the performance of microphones will be discussed in greater detail farther on.

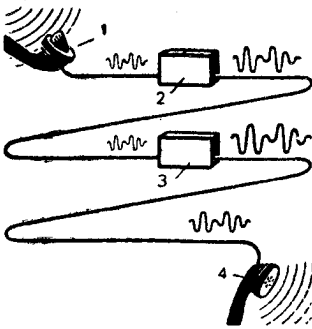

1 = microphone. 2 = amplifier I.
3 = amplifier II. 4 = telephone.

In the case of long-distance telephone calls the current fluctuations, which are quite weak to start with, are weakened still further on their long journey. It is necessary, therefore, that they be amplified from time to time. The equipment used for this purpose is called an "amplifier".

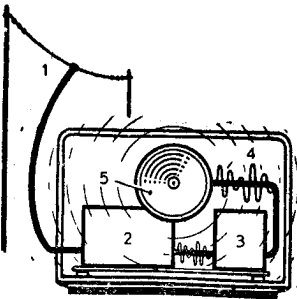

1 = aerial. 2 = actual receiver.
3 = amplifier is inside.
4 = amplified electrical oscillations. 5 = loudspeaker.

The application of the amplifier is certainly not restricted to telephone circuits. All radio receivers which operate with a loudspeaker include an amplifier. The radio waves picked up by the aerial are very weak and the sound waves which they carry along in electrical form require considerable amplification before they can be passed to the loudspeaker.

1 = microphone. 2 = pre-amplifier. 3 = main amplifier. 4 = transmitter. 5 = receiver.

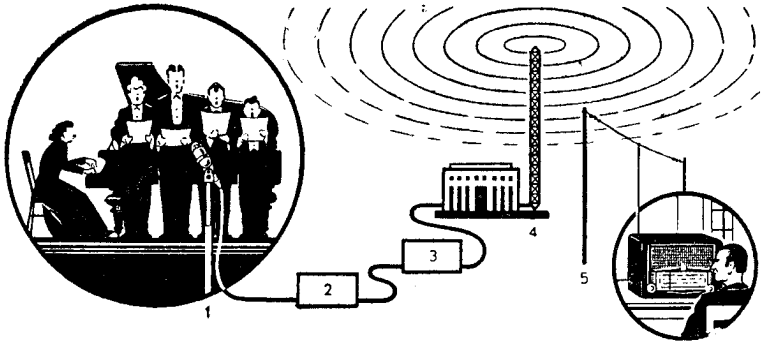

Amplifiers are used in great numbers in broadcasting. As stated before, the fluctuating microphone currents are very weak and are first amplified in a "pre-amplifier". Their amplitude is stepped up still further in more powerful amplifiers before they are superimposed on the carrier wave of the transmitter.

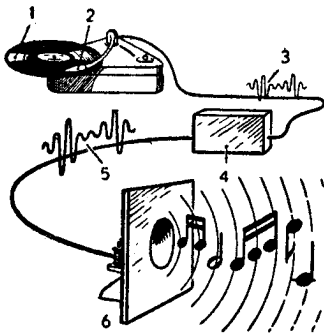

1 = record. 2 = electric pick-up.
3 = weak current. 4 = amplifier.
5 = stronger current. 6 = loudspeaker.

The pick-up, which is used for the reproduction of gramophone records, likewise produces a very weak current, of which the fluctuations correspond to the recorded sound waves. Loudspeaker reproduction would be absolutely impossible without an amplifier.

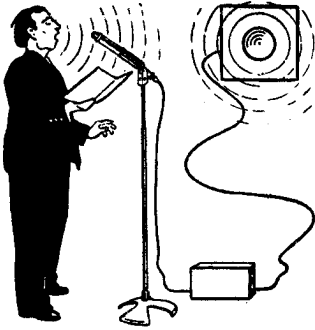

The microphones used by speakers are invariably connected to amplifiers, which are capable of producing the powerful current fluctuations required to operate the loudspeakers in the hall. Amplifiers of various sizes will be discussed in the appropriate section.

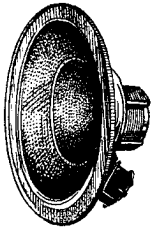

A few remarks on the subject of loudspeakers. Strictly speaking, they operate on the same principle as the telephone "receiver" discussed a little farther back. The only difference is that they are more powerful. Special loudspeaker designs have resulted in a continuous improvement in the quality of reproduction. The task of this type of reproduction equipment is invariably the same, viz. to convert inaudible electric current fluctuations into audible sound waves. More will be said about loudspeakers later on in this chapter.

B: Microphones



Electrical ear.

The task of the microphone should now be sufficiently clear. Briefly speaking, it is an electrical ear.

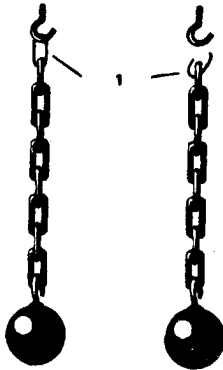

1 = weak first link.

The better it "hears", the better the reproduction of the sound it picks up and the more efficient it is. The microphone is the first link in what is often a very long chain and should, therefore, fulfil the most stringent requirements. If the first link is bad, the whole system will be unsatisfactory, however good the other links may be.

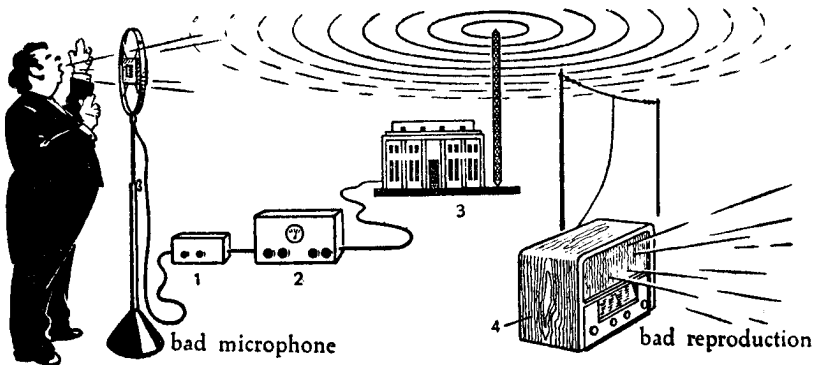

1 = good pre-amplifier. 2 = good main amplifier. 3 = good transmitter. 4 = good receiver.

The quality of a broadcast is determined first and foremost by the microphone in the studio. If it is of inferior quality, the broadcast will also be bad and the best of amplifiers, transmitters, tubes, receivers and loudspeakers cannot improve it.

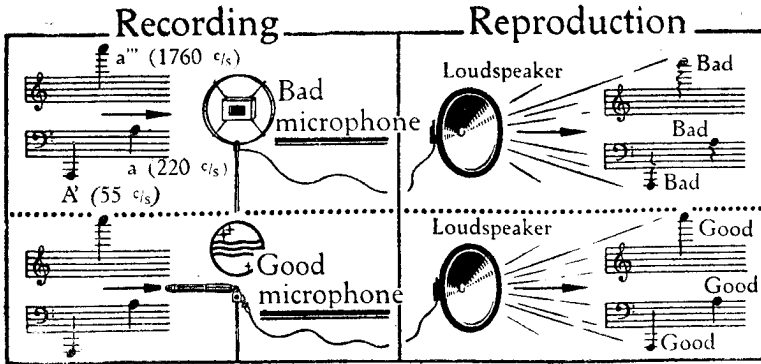

One of the first requirements that a good microphone has to meet is that it should have a good "frequency response", which simply means that it should be capable of registering all tones, from the highest to the lowest, equally well (including all side and overtones). The tone A' with 55 c/s, should be registered and converted into electric current fluctuations just as well as, for example, the tone two octaves higher, with 220 c/s, or the (three-times-accented) a''' three further octaves higher, with 1,760 c/s. The overtones which accompany the fundamental tone with still higher frequencies, should not be overlooked either, since they determine the "timbre" in sound reproduction.

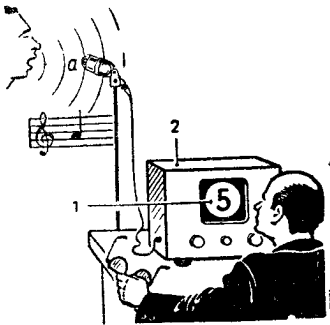

Let us assume that we have an instrument capable of assessing the efficiency of a microphone in values ranging from 0 to 8 for the full tone scale.

- a = microphone.
- 1 = rating from 0 to 8.
- 2 = testing equipment.

Rating	Represents
0	inaudible
1	much too weak
2	too weak
3	just satisfactory
4	good
5	very good
6	a little too loud
7	too loud
8	much too loud

These values have been incorporated in the table on the left and represent a certain performance range, in which 5 roughly corresponds to a performance which is "true to the original", while the values below 5 indicate a performance which is "too weak" and those over 5 a performance which is "too strong".

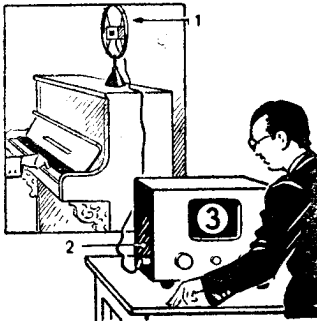

1 = old microphone. 2 = testing equipment. 3 = quality rate of microphone.

Now let us assume that someone strikes various notes on the piano, from the highest to the lowest, producing the same volume of sound each time. For each note the instrument will register the efficiency of the microphone connected to it.

Tone	Number of oscillations in $\%_s$	Rating
A	406	0
e	165	0
c	262	1
g	392	3
e ¹	659	5
b ¹	988	8
g ²	1568	6
e ²	2637	4
c ³	4186	2

Telephone

First of all an ordinary carbon microphone, such as that in a telephone handset, is connected to the instrument, which registers among others the values shown in the table.

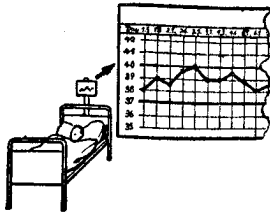

The table, as such, furnishes interesting data concerning the efficiency of the microphone under test. A much clearer picture is obtained, however, when the values found are plotted in a "graph". A good example of such a graph is the "temperature curve" of a patient in hospital.

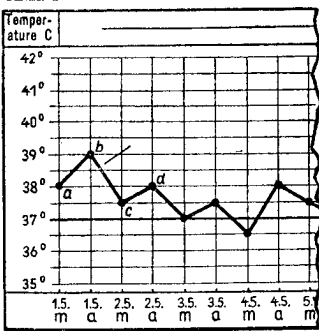

In a temperature graph the times at which the temperature of the patient is taken are set out along the horizontal line, while the temperatures are set out along the vertical line on the left. If the morning temperature on 1st May is 38° (100.4°F), a dot is placed against that temperature on the vertical line corresponding to the data in question. In the evening of the same day the temperature has risen to 39° (102.2°F), and another dot is placed at *b*. On the morning of the following day,

2nd May, the temperature has dropped to 37.5° (99.5°F) and a further dot is placed at *c*. In the evening of that day the temperature again shows a small rise to 38° (100.4°F) and a dot is placed at *d*, etc. The dots are then connected by means of a line, resulting in a "temperature curve", which enables the doctor to see at a glance how the patient is doing. In practice the temperature scale is further subdivided down to tenths of degrees.

Frequency response curve of post-office microphone.

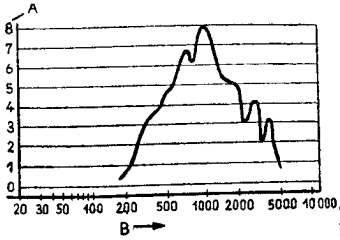

*Relative acoustic sensitivity. Frequency in c/s.
A = relative acoustic sensitivity
B = frequency in c/s.*

The frequency response curve of the microphone checked with the test instrument is plotted in exactly the same way. The frequency values are shown along the bottom horizontal line, while the sensitivity values corresponding to the frequencies are set out along the vertical line.

In accordance with the value shown by the test instrument a dot is entered for each frequency corresponding to the pitch of the tone, e.g. at 5 for 640 c/s (as shown by the instrument 8 for 960 c/s, etc. A line is drawn through the dots and the frequency response curve is complete.

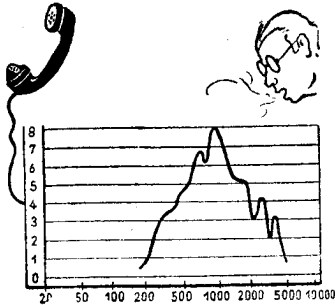

It will be seen straight away that the frequency curve of the carbon microphone is not satisfactory. Neither the low tones nor the high tones and the overtones are registered efficiently. Only in the middle tone range is the performance of the microphone anywhere near satisfactory.

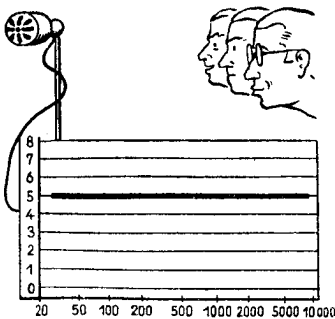

*Frequency in c/s.
An ideal microphone gives an ideal frequency response curve (=linear).*

It will be clear from the foregoing that the ideal frequency response curve should be a straight line, since only in that case will the microphone register and handle the various tones with uniform efficiency.

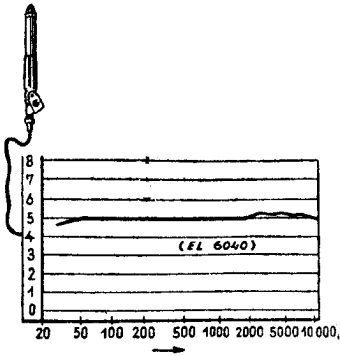

Frequency response curve of Philips moving-coil microphone.

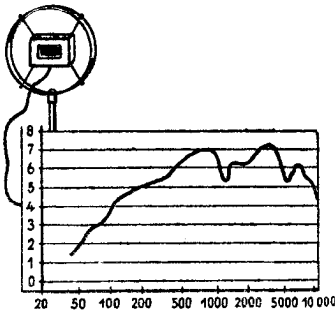

*Frequency in c/s
Frequency response curve of an old broadcasting microphone.*

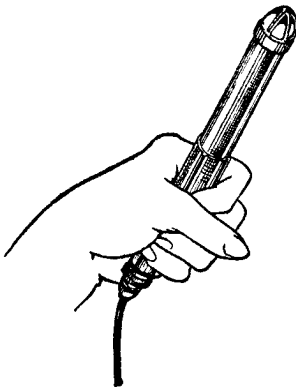

But ideal conditions just do not exist, not even with microphones. Philips sound engineers, however, have succeeded in creating almost ideal conditions for the microphones designed by them. The frequency response curve of the Philips "moving-coil" microphone shown here, for example, is almost ideal, being practically linear. So far we have used the values 0 to 8 to indicate the efficiency of the microphones discussed, but in electro-acoustics the unit of measure employed is the "decibel" (abbr. db), the origin of which has already been explained.

When we study the frequency response curve of an old type of microphone, such as that used in early broadcasting, it will be seen that it is certainly better than that of the carbon microphone of a telephone handset, but it is by no means satisfactory.

The illustration shows the Philips EL 6040 microphone. Owing to its special design; it is inconspicuous and so light that it can easily be carried in the hand. It is not always possible to avoid rough handling of microphones, and with the Philips microphones this is not necessary. They may have a "delicate inside", but they are of rugged construction.



The older types of microphones were very susceptible to the effects of the weather, such as heat and cold, dampness and dryness. They had to be carefully watched, particularly when used in the open air.

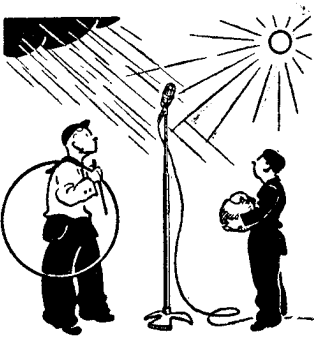

Philips microphones are not affected by heat, dryness, dampness, cold, rain or sunshine. Neither are they affected by sea air or chemical fumes. Hence, they are just as efficient in the jungle as in a concert hall.

All Philips microphones are "all-weather-proof"

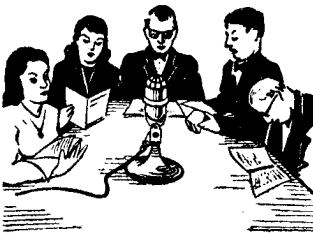

Sometimes a microphone is required which should be capable of picking up sound from all directions, as illustrated here. The microphone should, therefore, be omni-directional.

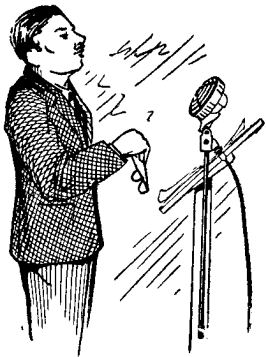

In some cases a microphone is required to react to sound from one direction only. If an "omni-directional" microphone were arranged as shown in the drawing, it would not only react to the voice of the speaker, but would also pick up the noise from the hall. The microphone should be "uni-directional" in this case. For this purpose Philips manufacture so-called hyper-cardioid microphones. What this means will be explained farther on.

Philips manufacture both uni-directional and omni-directional microphones. In this respect nothing is left to chance, each microphone being carefully tested to determine — what the sound engineer calls — its "directional effect".

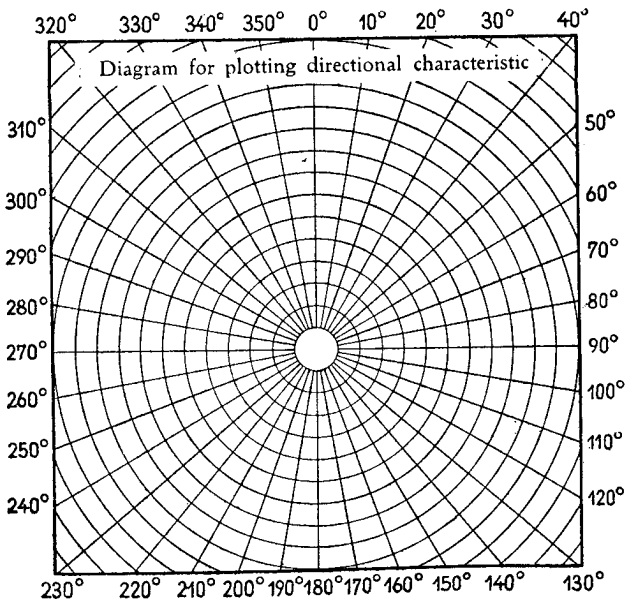

The engineers have a special type of graph paper on which they plot this directional effect. They cause a sound of a certain pitch to strike the microphone from all directions and measure the reproduction of the microphone for each direction. The results of the measurements are plotted on this paper.

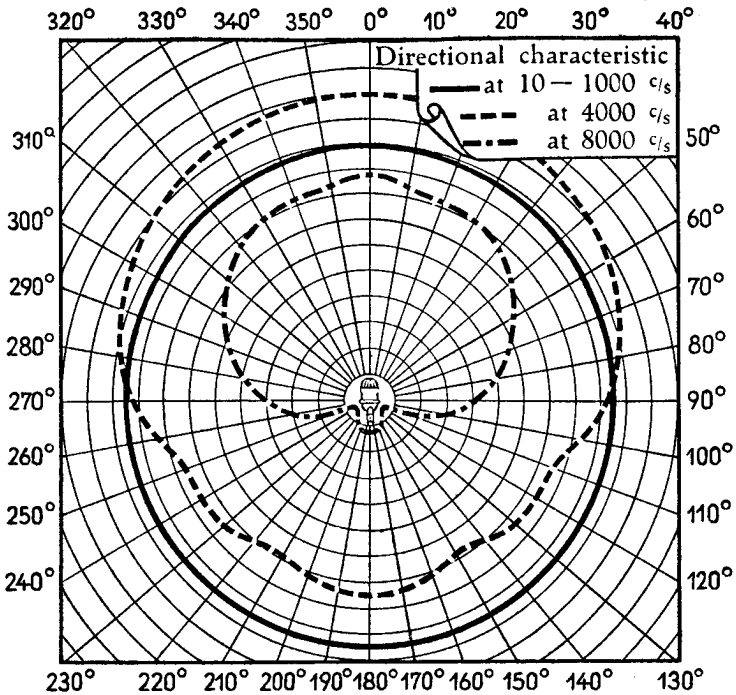

The unbroken line represents the directional effect for tones between 100 and 1,000 c/s. For these tones the microphone is evidently sensitive in all directions. Only for the higher tones is it less sensitive in the lower half of the diagram. The microphone is therefore typically omni-directional.

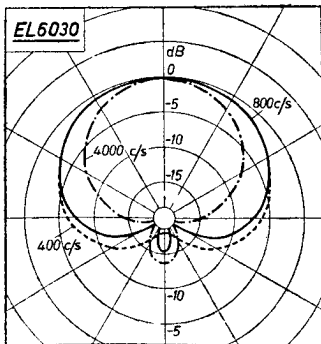

This diagram shows an entirely different directional effect. At the front this microphone is equally sensitive to all tones and practically a uni-directional microphone. It fully registers the voice of the speaker, but does not pick up the noise from the hall.

The shape of the curves resembles that of a heart. The Latin word for heart is "cardiacus", which explains the name "cardioid microphones". Of all cardioid microphones the Philips type EL 6030

microphone is the least sensitive to background noise and for this reason it is called a "hyper-cardioid" microphone.

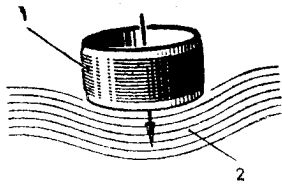

1 = moving coil. 2 = magnetic field.

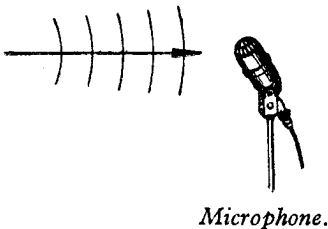
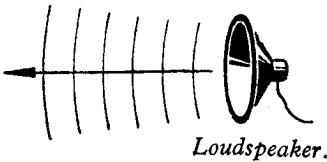

We have now come to the point where we should devote a few words to the "moving-coil" microphone. As its name suggests, this microphone has a small coil which moves in a magnetic field.

A moving-coil microphone is the reverse of a moving-coil loudspeaker. The moving-coil loudspeaker, however, is usually referred to as an "electro-dynamic loudspeaker". A loudspeaker receives electric current and produces sound waves which correspond to the current fluctuations. The moving-coil microphone, on the other hand, picks up sound waves and produces corresponding alternating currents in the line to which it is connected. If connected in the appropriate manner, a loudspeaker can also be used as a microphone.

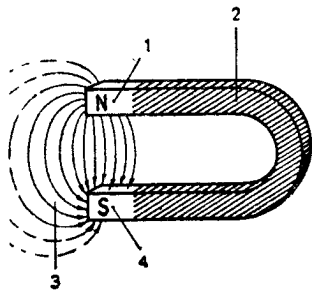

1 = north pole. 2 = horseshoe magnet. 3 = flux lines. 4 = south pole.

A brief explanation of the physical principles involved in the construction of the moving-coil microphone will prove useful. Between the two "poles" of a magnet there is a field of magnetic lines of force. It is, of course, invisible, but it is not difficult to prove that it is there. The lines of force (flux lines) run from the north pole to the south pole.

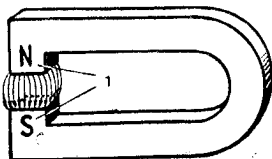

1 = pole shoes.

The lines of force can be bundled more closely if the poles of the magnet are provided with pole shoes.

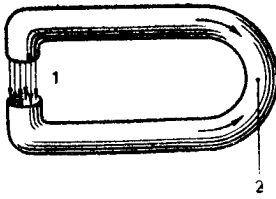

1 = air current. 2 = at this point a fan is built in.

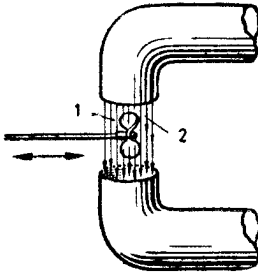

1 = wind gauge. 2 = air current.

Diagram of moving-coil microphone.

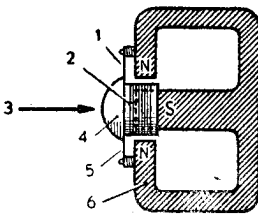

1 and 5 = springs for mounting moving coil. 2 = spring-mounted moving coil. 3 = sound waves. 4 = cap.

For the sake of comparison let us assume that the horseshoe magnet is hollow and that at the point of the bend it contains a small fan which creates a current of air. On one side the fan sucks in air and on the other side it discharges air, so that a closed circuit is formed. The open space between N and S forms part of this circuit.

We now mount a small propeller in the current of air between N and S. The propeller will start to rotate and its speed will vary in accordance with the depth to which it is introduced into the air current. It will stop rotating when it is withdrawn from the air current.

A similar situation exists in the case of the magnet. A small coil of a few turns of wire can be introduced into the magnetic field, in which case the magnet should have the form shown in the drawing. A current is set up in the coil, which will be stronger according as the coil is forced deeper into the magnetic field. This can be proved with the aid of a measuring instrument. The movement of the coil can be

caused by sound waves and, to render the impact of the sound waves more effective, the coil is fitted with a small cap. In the manner described in the foregoing the sound waves which strike the microphone are converted into corresponding current fluctuations, the result being an audio-frequency current in the line connected with the microphone. The coil moves in a very narrow "air gap" when the cap on the coil is struck by the sound. In the confined space the magnetic field is particularly effective.

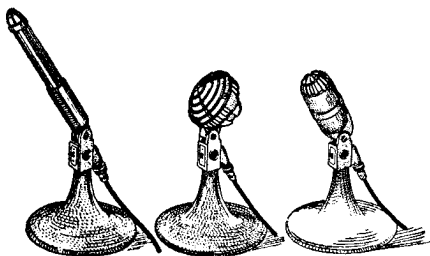

The three Philips microphones mentioned so far all have adequately protected built-in moving-coil units.

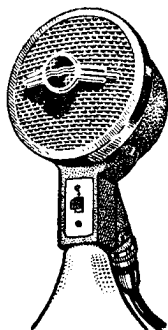

The Philips microphone type EL 6010 contains a similar unit. It is lower in price, but of the same rugged design. This microphone is chiefly intended for speech purposes and has been so designed as to ensure a good high-frequency response, since the high audio-frequencies are of particular importance for syllable intelligibility. This microphone can nevertheless be used equally well for music.

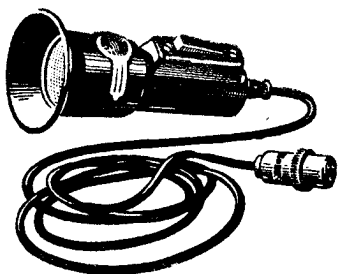

Another type is the Philips hand-microphone, which is particularly suitable for use with portable sound equipment.

As its name implies, it is held in the hand and specially intended for the transmission of speech. An important feature of this microphone is that even with strong background noise the voice of the speaker remains clear and distinct.



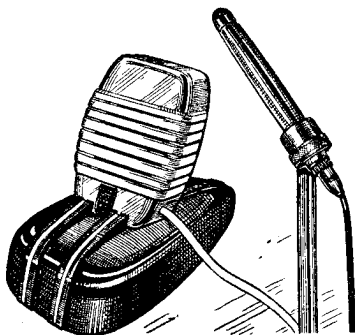

The Philips range of microphones comprises many different types, of which only a few have been mentioned so far. Pictured at utmost left you see a crystal microphone for small sound systems, magnetic recorders and amateurs transmitters. To the right a microphone of very high quality, which is chiefly used in broadcast, film and television studios. We shall continue with a brief discussion of the carbon, capacitive and crystal microphones.

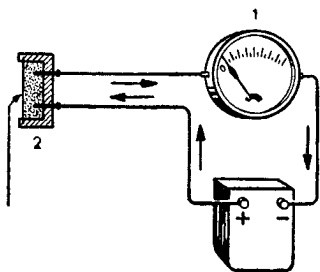

1 = current-measuring instrument. 2 = cross-section of microphone filled with carbon granules.

The oldest type is the carbon microphone and the principle on which it works is amply explained. It consists fundamentally of a housing filled with carbon granules and sealed with a thin tight diaphragm. Two contact pins extend into the carbon-filled space and are connected to a battery. For our experimental purposes a measuring instrument is included in the circuit. The carbon granules offer a certain resistance to the flow of current, so that the pointer of the instrument shows only a slight deflection. Only a weak current can flow through the circuit.

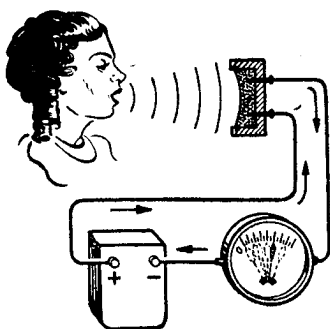

When sound waves of speech strike the diaphragm the carbon granules are compressed in the rhythm of the audio-frequencies (the diaphragm transmits the alternating sound pressure to the carbon granules). When the carbon granules are compressed their electrical resistance is reduced, so that the flow of current varies in accordance with the pressure of the sound waves.

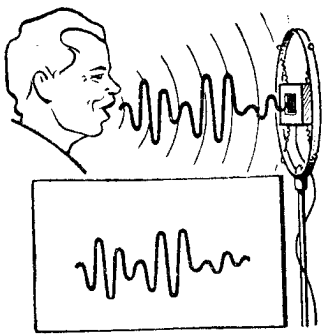

Graphical representation of current oscillations in microphone lines.

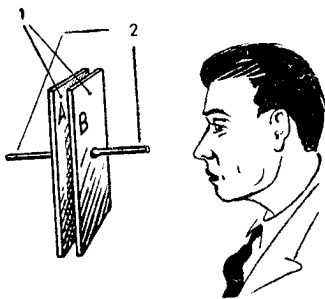

1 = metal plates. 2 = connections.

Cross-section of a capacitor microphone.

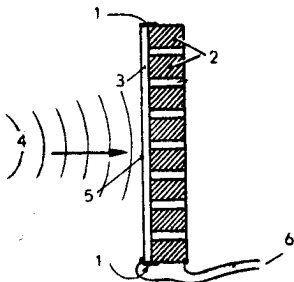

1 = insulation. 2 = rear electrode (perforated metal plate). 3 = small space. 4 = sound waves. 5 = diaphragm. 6 = connections.

The sound frequencies are thus converted into corresponding current fluctuations. To protect the microphone against vibration which might cause distortion, the better types used to be mounted in a heavy block of marble, which was suspended from springs. Advantages of the carbon microphone are: simple design and inexpensive. Disadvantages: bad frequency response and inherent background noise, which is particularly noticeable at low sound levels. The carbon microphone must be used with a battery to supply the current required for its operation.

The capacitive microphone works on an entirely different principle. It is clear from its name that its principal part is a capacitor. As stated before, a capacitor is a device consisting of two metal plates (A and B), which are mounted close together without making contact. The capacitance of a capacitor changes when the distance between the two plates is increased or reduced.

If a capacitor is incorporated in an electrical circuit in the appropriate manner, it will create voltage fluctuations in the line to which it is connected when the distance between its plates is subject to variation. In the capacitive microphone a fixed metal plate (B), which for certain reasons is grooved, is mounted opposite a thin metal diaphragm (A), which vibrates when struck by sound waves. The sound waves will appear in the circuit in which the microphone is included in the form of voltage fluctuations. The diagram shows a capacitive micro-

phone in cross-section. Advantages of the capacitive microphone: good frequency response curve, high-quality reproduction. Disadvantages: difficult to manufacture, the current fluctuations must be considerably pre-amplified, since they are very small, so that a special pre-amplifier is required. It is very susceptible to mechanical vibration and much higher in price than the moving-coil microphone.

Cross-section of a crystal microphone.

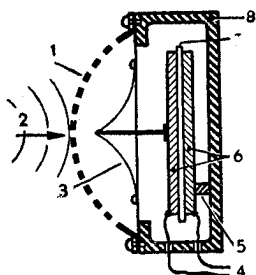

1 = protective gauze. 2 = sound.
3 = aluminium diaphragm (transmits sound pressure to crystal element). 4 = connections. 5 = support. 7 = case.

The operation of the crystal microphone is based on the so-called piezo-electric effect. When pressure is exerted on a quartz crystal clamped between two metal plates, an electric potential is set up across it. This property enables the quartz crystal to be used in microphones, in which the pressure on the crystal is varied at a high rate by the effect of the sound waves. The crystal element is very thin and consists merely of the crystal plate covered on both sides with tin foil. Advantage of the crystal microphone: inexpensive to manufacture. Disadvantages: susceptible to external influences and seriously affected by heat (at a temperature exceeding 50 °C or 120 °F the crystal is destroyed).



Output voltage? Impedance?

Two expressions used in connection with microphones, viz. "output voltage" and "impedance", have not yet been dealt with and require a brief explanation.

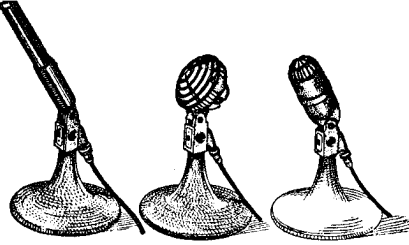

Nominal Voltage:

.5 mV 2.1 mV 1.25 mV

By output voltage is understood the electric potential that can be measured at the terminals of the microphone. It has very small values and is therefore measured in thousandths of a volt, i.e. in millivolts (mV). The illustration shows the corresponding nominal values of three different microphones.

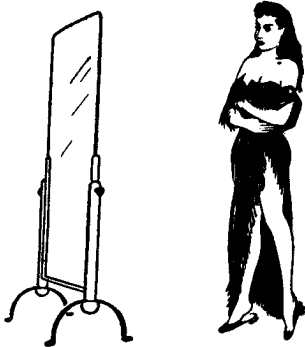

This gown does not match the figure.

When a microphone is connected to an amplifier certain measures must be taken to ensure that it is matched to the length of the cable and the resistances present, just as a gown should match the figure, since otherwise the quality of reproduction will be impaired.

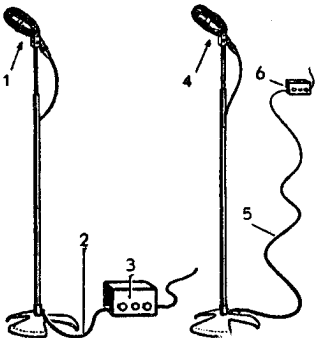

When the line (2) between microphone (1) and amplifier (3 and 6) is short, a high impedance value is selected (10,000 ohms). When this line (5) is long the microphone (4) is adjusted to a low impedance value (50 ohms).

When the amplifier and the microphone are close together the procedure adopted will differ from when they are a considerable distance apart. For this reason the Philips microphones are equipped with a device which permits them to be matched to the line in a simple manner. The A.C. resistance, which is the type of resistance we are concerned with in the case of constantly alternating speech currents, is called the "impedance". Three matching possibilities are provided, namely for impedances of 10,000 ohms, 500 ohms and 50 ohms. When the line between the microphone and the amplifier is short a high impedance value is selected

(10,000 ohms) and when the line is very long the microphone is adjusted to a low impedance value (e.g. 50 ohms). Even with long lines no interference voltages or loss of treble occur.

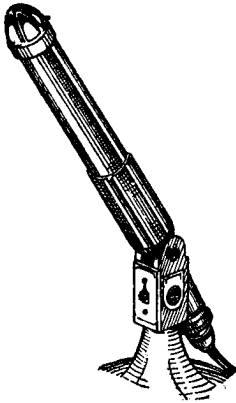

TYPE EL 6040

Impedance	Output voltage	Level
25,000 Ohms	1.5 mV—	56.5 db
500 Ohms	0.23 mV—	73 db
50 Ohms	0.07 mV—	83 db

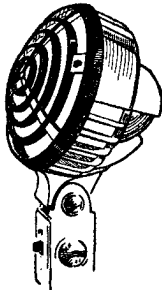

TYPE EL 6030
(Hyper-cardioid)

10,000 Ohms	2.1 mV—	53.5 db
500 Ohms	0.45 mV—	67 db
50 Ohms	0.14 mV—	77 db

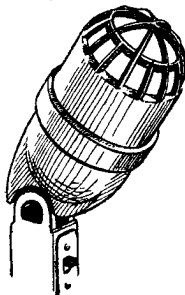

TYPE EL 6020

10,000 Ohms	1.25 mV—	58 db
500 Ohms	0.25 mV—	72 db
50 Ohms	0.08 mV—	82 db

It should be added that the output voltage is lower according as the impedance is lower. The illustration shows three Philips microphones with the corresponding impedance and output-voltage values.

The Philips moving-coil microphones can be used for practically all sound-reproduction purposes. They can be mounted on a floor-stand anywhere in the room

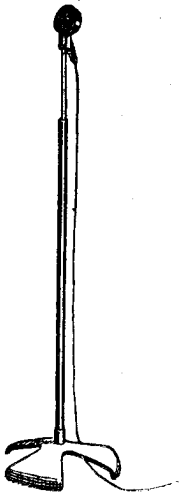

. . . .or, in combination with a suitable base, on a desk or table.

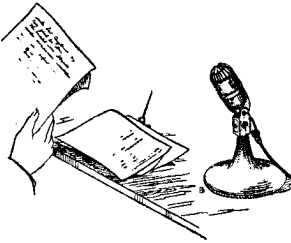

The connection of the Philips microphones is provided with internal $3/8''$ Whitworth thread, a type widely used for all kinds of machines and steel structures and it should not be difficult to find a screw to match it. This facilitates mounting the microphone in some other way than on a stand.

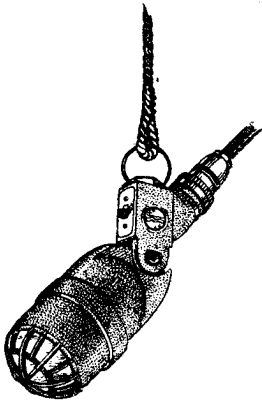

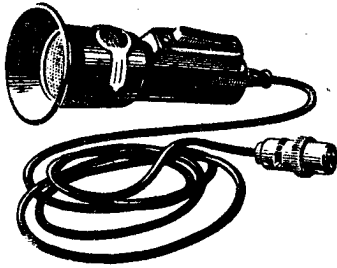

It often occurs that the microphone must be used in the immediate vicinity of the loudspeaker, for example in a loudspeaker van. The ordinary type of microphone is apt to cause acoustic feedback in the form of loud howling and whistling as soon as it comes within the beam of sound from the loudspeaker.

For such applications Philips have designed a special type of moving-coil hand microphone with a number of features which render it remarkably free from troublesome feedback.

Moreover, the microphone is equipped with an acoustic filter ensuring a good high-frequency response, so that it is admirably suitable for all kinds of announcements and can be used in cars immediately below the loudspeakers mounted on the roof.

C: Amplifiers

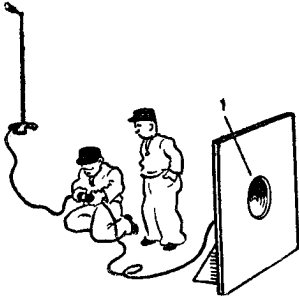

1 = loudspeaker.

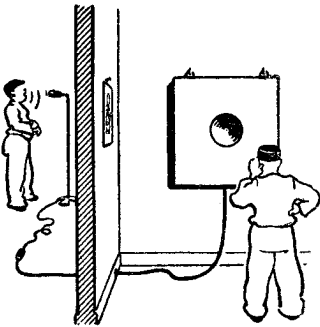

A mere connection between microphone and loudspeaker will give no results.

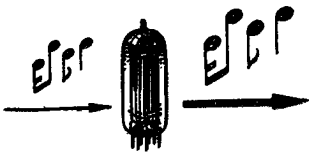

An electronic tube is capable of amplifying weak voltage fluctuations.



It would just be too easy if the microphone could be connected direct to the loudspeaker.

It can be done, of course, but the result will be exactly nil. The loudspeaker will not react to the weak voltages produced by the microphone. A device must therefore be provided, which turns “soft” into “loud”, i.e. a device capable of amplifying the weak voltage fluctuations.

We have learnt from the preceding chapters that this can be achieved with the aid of electronic tubes.

The small voltage fluctuations from the microphone are fed to the tubes. The strong direct current, which is obtained from an independent source, flows through the anode circuit of the tubes and produces amplified fluctuations corresponding to those of the microphone voltages.

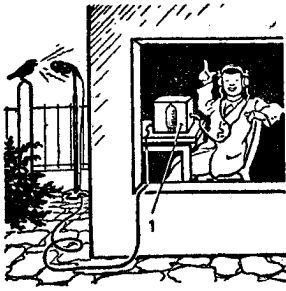

1 = single-tube amplifier.

The tubes cannot do the job by themselves, and further circuit components are required to assist them in their task. Together with the tubes they are assembled in a self-contained unit, which is connected between the microphone and the instrument employed to reproduce the sound.



1 = 1st tube. 2 = 2nd tube.
By means of these two tubes a double amplification will take place.

If only one tube is used for amplification, the result will not be very satisfactory. The amplification factor will generally prove to be too small. A second tube can be added, which amplifies the output voltage of the first tube still further.

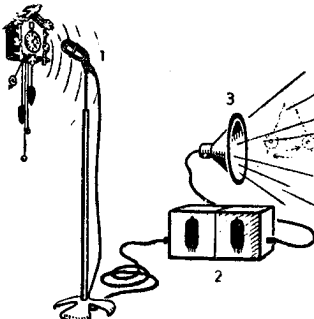

1 = microphone 2 = two-tube amplifier. 3 = loudspeaker.

Whereas a single-tube amplifier is just strong enough to operate a pair of headphones, a "two-stage" amplifier is sufficiently powerful to operate a loudspeaker.

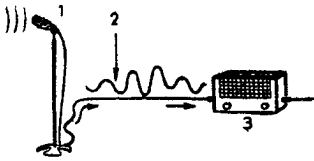

1 = microphone. 2 = low-frequency oscillations. 3 = LF-amplifier.

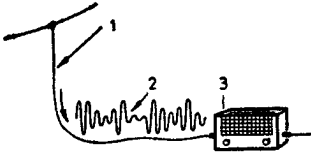

1 = aerial lead-in. 2 = high-frequency oscillations. 3 = HF-amplifier.

The apparatus employed for the amplification of speech and music currents is called a "low-frequency amplifier" or, briefly, an "LF amplifier", as opposed to the high-frequency amplifiers" (HF amplifiers) whose task it is to amplify the rapidly oscillating (high frequency) radio waves.



Cinema with high frequency.

The terms "high-frequency" and "low-frequency" can be better understood if we compare two cinemas one of which is frequented by a large number of people (high-frequency)

A large number of waves within this space.

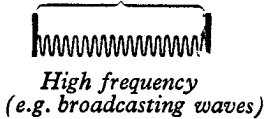

Cinema with low frequency.

A small number of waves within this space.

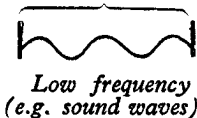

and the other by a small number of people (low-frequency). The low-frequency waves comprise both the audible sound waves of between 20 and 16,000 cycles per second and the inaudible sound waves in the infrasonic and supersonic ranges, irrespective of whether they are air waves or their electrical counterparts.

1 = sound-waves (air oscillations). 2 = air. 3 = mechanical oscillations of the diaphragm. 4 = microphone. 5 = microphone current (electrical oscillations). 6 = line.

7 = LF amplifier. 8 = line. 9 = mechanical oscillations of the diaphragm. 10 = loudspeaker. 11 = sound-waves (air oscillations). 12 = air.

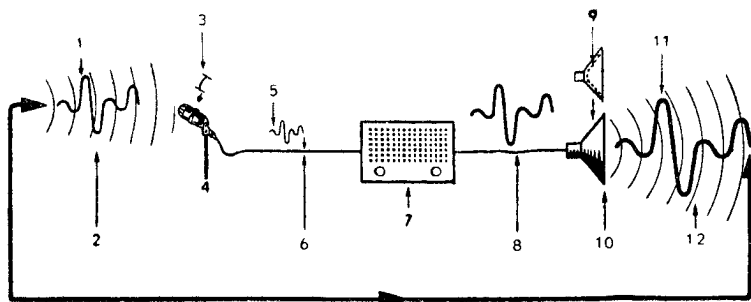

The task of the audio-frequency amplifier is shown in the above illustration and may be described as the amplification of various forms of sound which has first been converted into corresponding electric current fluctuations (for example by means of a microphone; see the section on microphones).

Broadcasting house

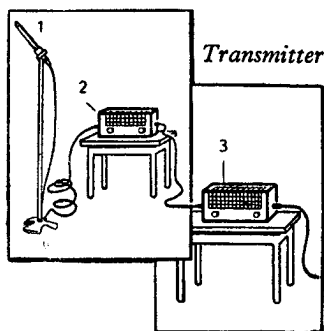

1 = microphone housing with built-in single-tube amplifier. 2 = pre-amplifier. 3 = main amplifier.

The LF amplifier has a wide range of applications. We have already discussed the necessity of amplifying the voltages produced by a microphone. There are microphones (capacitive microphones) whose voltage fluctuations are so weak that they must be amplified as soon as they are generated. This accounts for the unusual form of this type of microphone, which comprises a cylinder containing a single-tube amplifier mounted immediately below the microphone.

The Philips moving-coil microphones, on the other hand, do not require a special pre-amplifier,

which invariably involves a separate power supply. (See also the section on microphones.)

The amplification achieved in this way is inadequate and for this reason a second, more powerful, amplifier is provided. Sometimes a third amplifier is required, for instance when the microphone is located a considerable distance away from the studio or the transmitter (pre-amplifier and main amplifier).

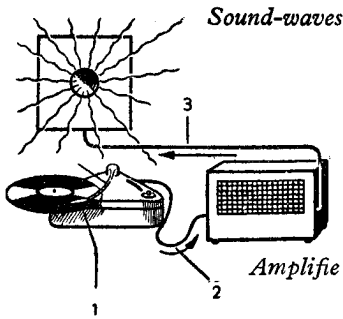

1 = weak mechanical oscillations.
 2 = weak current oscillations.
 3 = amplified low-frequency oscillations (current oscillations).

The electric "pick-up" used for playing gramophone records furnishes very low AF voltages (weak AF currents), which require considerable amplification before they can be made to operate a loudspeaker. In this case, too, an amplifier is indispensable.

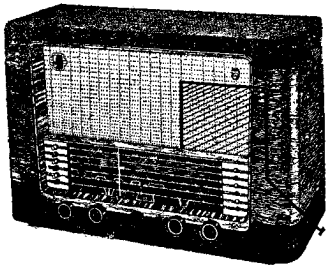

(1)

Broadcast receiver with built-in LF amplifier (1).

All radio sets include an LF amplifier whose task it is to amplify the audio-frequency signals produced by the actual receiver section until they are strong enough to drive the loudspeaker.

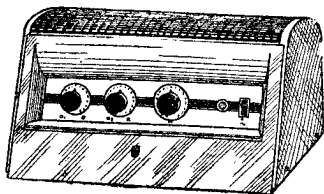

Philips manufacture large LF amplifiers capable of amplifying the output voltages of microphones and pick-ups as well as the audio-frequency waves produced by radio receivers.

Speech and music reproduction

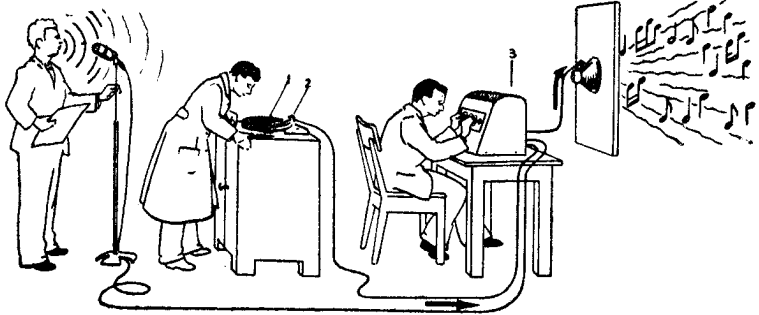

1 = record. 2 = pick-up. 3 = control-desk amplifier.

The Philips amplifiers are almost invariably equipped with mixing facilities, which means that the output of the microphone can be mixed with that of a gramophone, a pick-up or a tape recorder.

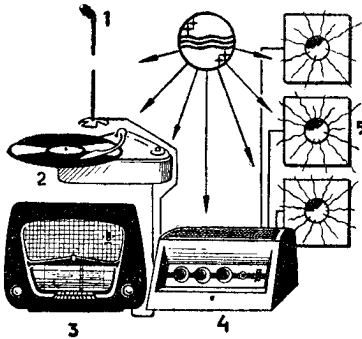

1 = microphone. 2 = pick-up.
3 = broadcast receiver. 4 = amplifier. 5 = loudspeakers.

A complete sound installation of this type is represented diagrammatically in the illustration on the left.

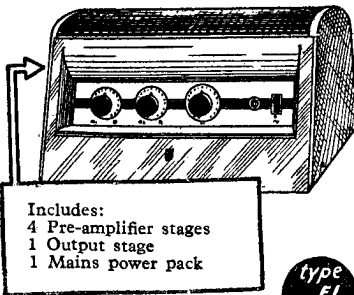

type
EL
6400

In addition to the power supply, the amplifier includes four "pre-amplification" stages with one tube each and a so-called push-pull output stage with two tubes.

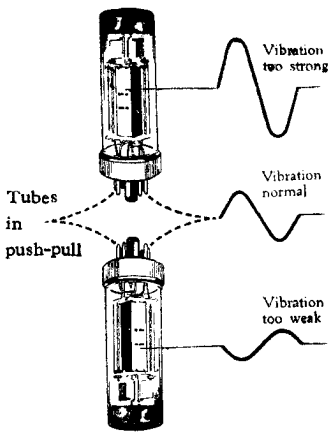

Tubes in push-pull.

As its name implies, the output stage is the last amplification stage, from which the output is fed to a number of loudspeakers. It operates on the "push-pull" principle, which means that the two tubes of this stage are so connected that the individual performance of one tube supplements that of the other. This is illustrated very diagrammatically in the drawing.

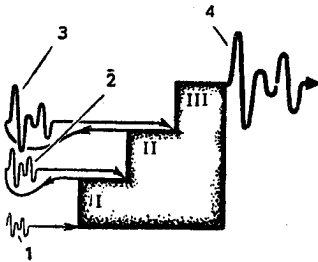

1 = signal at input. 2 = signal after first amplification. 3 = signal after second amplification. 4 = signal after output stage.
 I = 1st stage. II = 2nd stage.
 III = output stage.

The output stage is only a part of a complete self-contained amplifier. A microphone or a pick-up cannot be connected direct to an output stage, and the output of these instruments must first be amplified by a number of pre-amplification stages before it is powerful enough to drive the output stage. No one would think of sending a student to college without the necessary preliminary training.



Whether high or low, weak or loud, the amplification must be equally good.

It is an essential requirement of a good audio-frequency amplifier that it should as far as possible provide adequate amplification of the entire audio-frequency range (sound-wave range). The Philips amplifiers all meet that requirement.

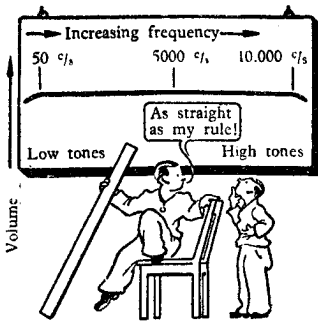

Their frequency response curves are linear between very wide limits, and for a number of types this linearity extends from 30 to 15,000 c/s.

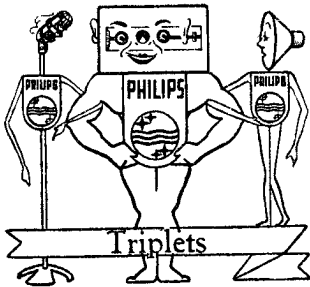

A Philips amplifier should be used with a Philips microphone and a Philips loudspeaker. These three get on well together.

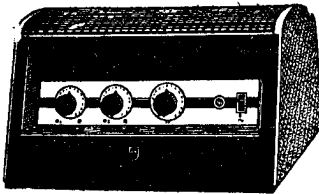

Output: 20 W.

The power delivered by an amplifier is called the "output power". In the case of the amplifier type EL 6400 shown in the illustration the output power is 20 watts. For the sake of comparison it is pointed out that the output power of most receivers is about 2 watts. The LF amplifier in the most powerful type of receiver does not produce more than 8 watts.

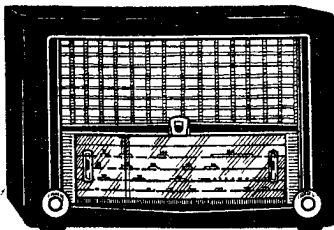

Output: 2.5 W.

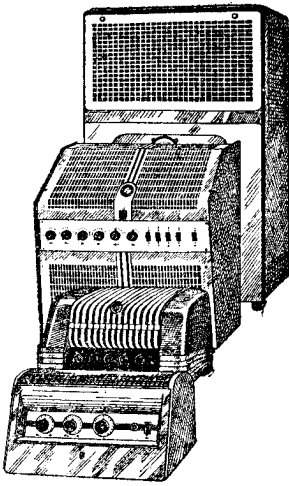

Philips manufacture a whole range of amplifiers with output powers of 20 watts, 40 watts, 70 watts, 200 watts, 1,000 watts and even higher.

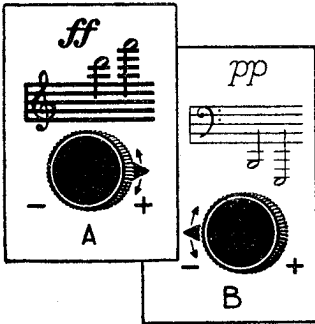

*A = high tones boosted.
B = low tones attenuated.*

The larger types of amplifiers usually have connection facilities for two microphones, two gramophones, receivers or tape recorders, while in addition they are equipped with controls for boosting or attenuating the bass and the treble.

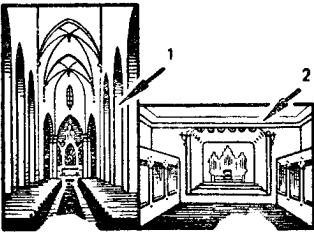

This enables the reproduction to be adapted to the acoustic conditions of the space in which the equipment is used.

Space acoustics in 1 different from 2. But Philips in both cases.

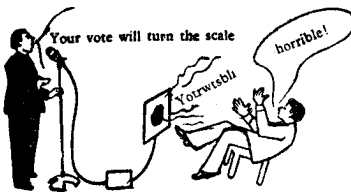

Ordinary amplifier.

the result that the amplifier is overloaded, so that the loudspeakers emit a loud unintelligible noise.

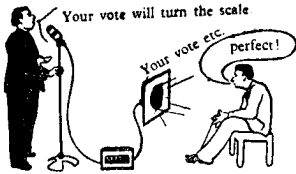

Philips 70-W amplifier.

As with so many things in life, it is the apparently unimportant detail that makes all the difference in sound-amplification. The Philips 70-watt amplifier type EL 6420, for example, is equipped with a limiter. It sometimes occurs that a speaker in his enthusiasm shouts into the microphone, with

This cannot happen with the Philips 70-watt amplifier, as the limiter prevents overloading. The speech from the loudspeakers is undistorted, not too loud and clearly intelligible.

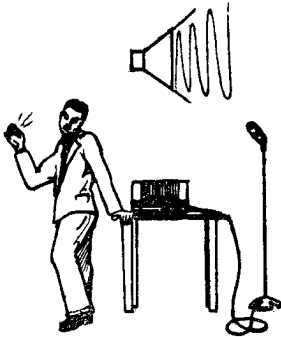

Practically all amplifiers cause a loud unpleasant "howl" when the volume control is turned up too far. The Philips 70-watt amplifier, however, has two additional controls, to which only the expert has access. Once these controls have been suitably adjusted, the amplifier will never howl, however much the layman turns the other controls.

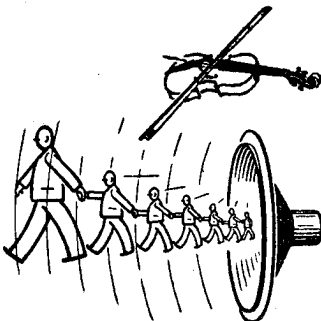

No overtones: good reproduction!

One often sees the word "distortion" used in connection with LF amplifiers. What does this mean? In a previous chapter we have seen that a fundamental tone derives its "timbre" from its "overtones". This enables us to distinguish the same tone produced by a violin, a flute, an organ, etc. These overtones must also be reproduced to ensure "true-to-life" reproduction.

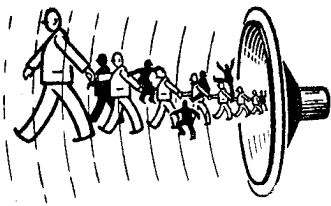

Additional overtones spoil the tone: bad reproduction.



1 = originally intended tone. 2 = distortion.

However, if the overtones are accompanied by further undesirable components, the reproduction will be distorted. The addition of these undesirable frequencies should be avoided as much as possible.

The sound-engineer refers to the extent to which these undesirable components are present as the "distortion factor", which is usually expressed as a percentage. As a rule a distortion factor of 10 per cent is noticeable, and under favourable conditions a distortion factor of 5 per cent will not pass unnoticed. The distortion factor of the majority of Philips amplifiers is considerably lower, and for many types as low as 1 or 2 per cent.

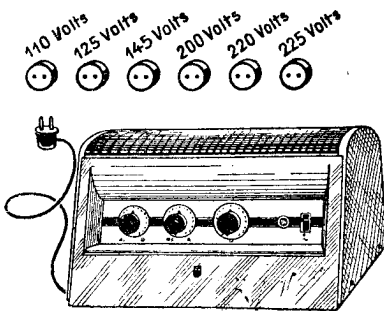

Philips amplifiers can be connected to any mains voltage!

Modern amplifiers are, of course, operated from the mains. This will be discussed in greater detail elsewhere, and it will suffice to mention here that the Philips amplifiers can be operated on a wide range of mains voltages. The simple adjustment of the mains voltage adapter will enable the amplifier to be operated on mains of 110, 125, 145, 200, 220 or 245 volts.

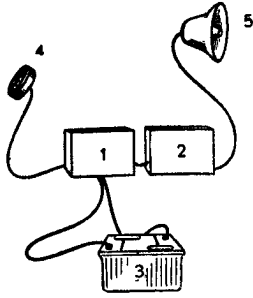

1 = 5-watt amplifier. 2 = vibrator.
3 = battery. 4 = microphone.
5 = loudspeaker.

There will always be places where a mains supply is not available, so that the ordinary type of amplifier cannot be used. For this reason Philips manufacture special types of amplifiers, which, for example, can be used in cars. The illustration shows a very useful amplifier, with an output of 5 watts. This is sufficient to ensure audibility over a distance of 300 metres, even in dense traffic.

D: Loudspeakers

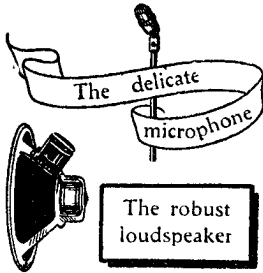

The object of a loudspeaker is to radiate sound waves of adequate strength. Its function is therefore the opposite of that of a microphone. This does not mean that a microphone can simply be used as a loudspeaker. The two instruments are designed to fulfil their specific individual requirements. It will be appreciated that microphones are delicate instruments and should be treated as such,

while loudspeakers are of rugged construction.

There are a number of loudspeaker types, but only the "dynamic" variety is now generally applied. It can also be referred to as a moving-coil loudspeaker, since — as in the case of the moving-coil microphone — its principal part is a small coil which moves in a strong magnetic field. In a microphone currents are created in the coil as a result of the pressure exerted on it by sound waves, but in a loudspeaker the varying electric currents cause the mechanical vibration of the coil. A "cone" attached to the voice coil converts this vibrating movement into air waves or sound waves.

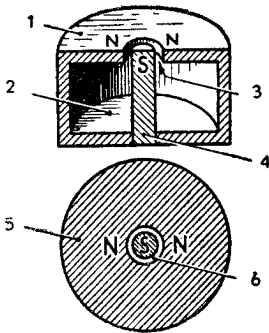

1 = cover. 2 = magnet box (cross-section). 3 = air gap. 4 = core. 5 = magnet box (top view). 6 = air gap.

We shall now quickly run through the physical principles involved. We already know about the lines of force between the poles of a magnet (in this case pot-shaped)....



1 = winding. The small moving coil.

...and we also know that the voice coil is a small coil consisting of a few turns of wire.

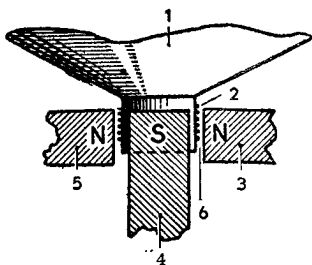

1 = cone or diaphragm. 2 = voice coil. 3 and 5 = cover. 4 = core. 6 = air gap.

current flows in the opposite direction, it will be seen that the coil is forced out of the magnetic field. It will now be clear that an alternating current, i.e. a current which constantly changes its direction, will cause the coil to move to and fro between the poles of the magnet in the rhythm dictated by the current changes.

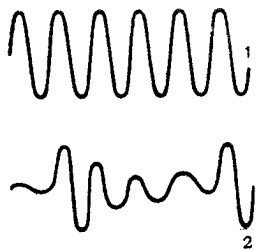

1 = normal alternating current. 2 = amplified microphone current.

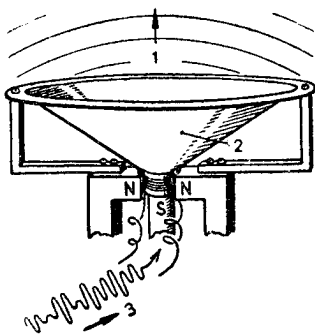

1 = sound. 2 = cone or diaphragm. 3 = from amplifier.

The voice coil moves in the air gap, which is only a few millimetres wide. As stated above, the loudspeaker cone is attached to the voice coil.

We now connect the coil connections to a battery via a switch. When the circuit is closed by means of the switch, so that current flows through the coil, it will be seen that the coil is drawn into the magnetic field.

If we repeat the experiment after we have changed over the connections of the battery, so that the

The currents supplied to the loudspeaker by the amplifier are alternating currents, but of a special kind. Their course is not uniform and they resemble sound of waves, because their frequency and their amplitude vary. When these (audio-frequency) currents are passed through the voice coil, the mechanical movements of this coil will correspond to the electric-current fluctuations in it (e.g. the amplified microphone currents).

The mechanical vibrations of the voice coil are transmitted to the flexibly suspended cone-shaped diaphragm, which in turn transmits them to the surrounding air. Thus, sound waves are created which correspond to the audio-frequency current fluctuations.

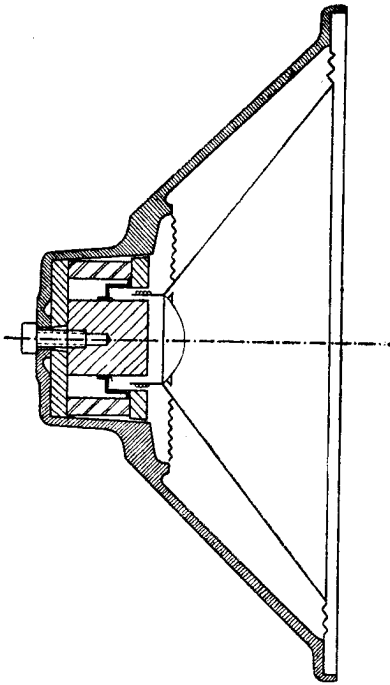

Can be used in any position.

A centering device ensures that the voice coil remains freely suspended in the air gap, while the diaphragm has a corrugation near the outer edge, to provide the required flexibility. The loud-speaker can, therefore, be mounted in any position.

*Electro-dynamic loudspeaker
(cross-section).*

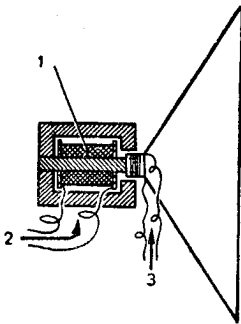

1 = magnet coil. 2 = direct current. 3 = speech and music currents.

Formerly "electro-dynamic" loudspeakers were used. These were equipped with electromagnets. The iron core of the pot-shaped magnet was provided with a coil of a large number of turns, through which direct current was passed with a view to the achievement of a very powerful magnetic field in the air gap. Nowadays preference is given to "permanent" magnets, which do not require a special current supply. They are actually more powerful than the electro-magnets.

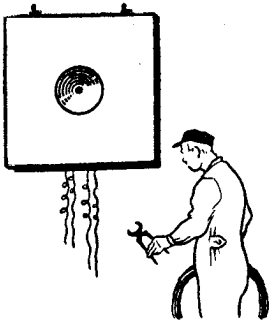

Electro-dynamic loudspeaker with too many wires.

The old-fashioned design is still encountered, but it has many disadvantages. From the installation point of view, for example, it involves a troublesome complication, in that in addition to the two wires carrying the speech currents a further two wires are required for the direct current supply to the electromagnet of the loudspeaker. Unless the loudspeaker is mounted in a radio receiver, a separate rectifier must be provided for the field coil supply. This constitutes a serious drawback in the case of public address and music systems.

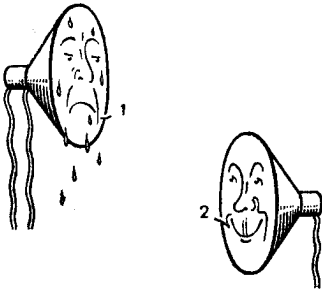

1 = old fashioned electrodynamic loudspeaker. 2 = permanent dynamic loudspeaker with much greater capacity.

The current flowing through the field coil of the electromagnet heats up the whole loudspeaker, which is undesirable in many respects. The delicate moving parts will age more quickly, while in a damp atmosphere the loudspeaker will start to "perspire", i.e. water is formed by condensation, which in the long run will prove harmful to the system.



The power which a loudspeaker can handle is expressed in watts. As a rule the rating of a loudspeaker denotes the maximum power which it is capable of handling. Thus, a 6-watt loudspeaker need not necessarily be operated on 6 watts and can, in fact, be operated just as well on 1 watt.

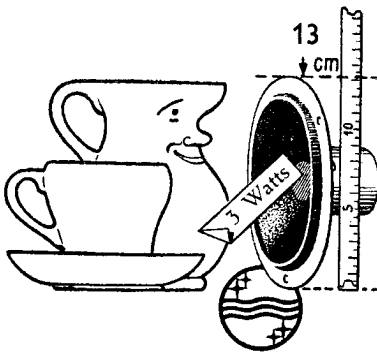

One of the smallest Philips models is a 3-watt loudspeaker. It is 13 cm in diameter and is, therefore, not much bigger than a milk jug. This "little fellow" has a wide range of applications and can be used, for example, as an extension loudspeaker for a radio set.



"I can hear it, but where is it?"

It is particularly useful for applications in which the loudspeaker should be as inconspicuous as possible. Moreover, it can be used to advantage in large installations, for example in large rooms or halls, in which, owing to reverberation, perfect reproduction can only be achieved with small units.

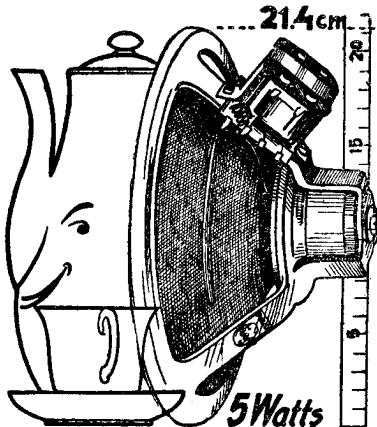

Here is a 6-watt model, which can handle about twice as much power as the "little fellow". It need hardly be pointed out that all Philips loudspeakers are of the permanent magnetic type and thus have a long life.

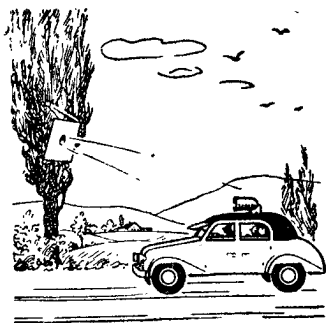

The Philips 6-watt loudspeaker is particularly suitable for sound reproduction in the open air and when mounted in a horn it can also be used on cars.

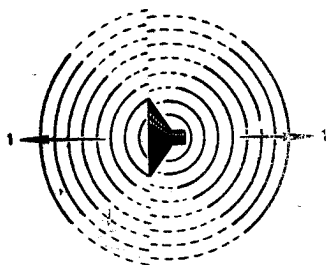

1 = sound-radiation.

For specific reasons a loudspeaker is sometimes mounted on a "baffle". One of these reasons is that without a baffle the low tones are not efficiently reproduced. Equalization of pressure may occur in front of and behind the loudspeaker, if this is not prevented by the provision of an obstacle in the form of a baffle. The loudspeaker now radiates sound both in a forward and in a backward direction.

Front of loudspeaker | Back of loudspeaker

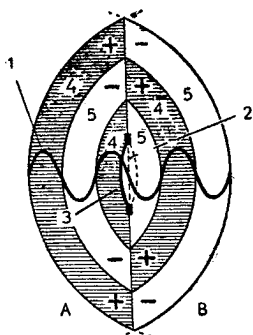

1 = sound-wave. 2 = diaphragm in rest position. 3 = diaphragm in vibration. 4 = pressure. 5 = suction.

The situation is so that a pressure maximum in front of the loudspeaker coincides with a pressure minimum at the rear. In front the cone compresses the air, while it simultaneously rarefies the air at the rear. The illustration shows the resulting situation in the case of a flat, stretched, diaphragm.

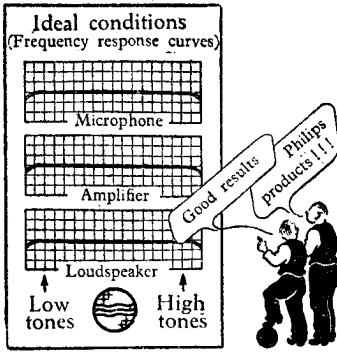

It is found in practice that the efficiency of a loudspeaker without a baffle (or a horn, about which more will be said later) is not the same for the whole range of audio-frequencies. Just as in the case of microphones and amplifiers, the frequency response curve of a loudspeaker should be as linear as possible, to ensure high-quality sound-reproduction.

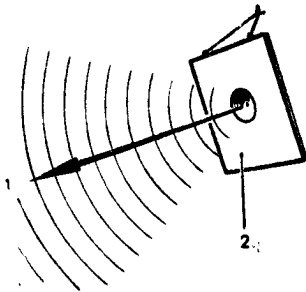

1 = principal direction of radiation. 2 = baffle board.

Finally, the baffle causes the sound to be radiated essentially in one direction.

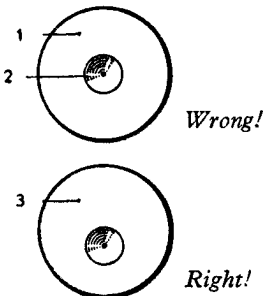

When a round baffle is employed, it is quite wrong to cut the hole for the loudspeaker exactly in the centre. The sound reproduction can be considerably improved if the hole is made slightly out of centre.

1 = baffle board. 2 = loudspeaker. 3 = baffle board.

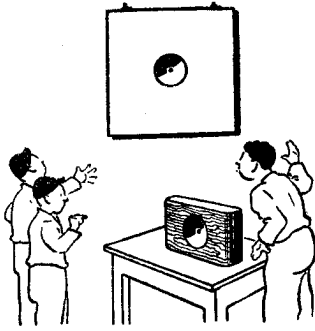

From the acoustic point of view a good loudspeaker cabinet is much better than the unwieldy baffle board. The cabinet can be open or closed, dependent on the characteristics of the loudspeaker in question. In any case the dimensions of the cabinet are invariably much smaller than those of a baffle board producing the same acoustical effect.

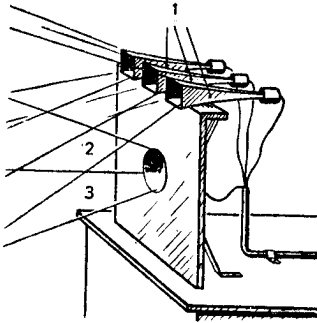

If the quality of reproduction must fulfil the highest requirements and at the same time a large volume of sound is desired, separate loudspeakers are used for the bass and for the treble. Installations of this type may be found in cinemas.

*1 = loudspeaker for high tones.
2 and 3 medium and low tones.*

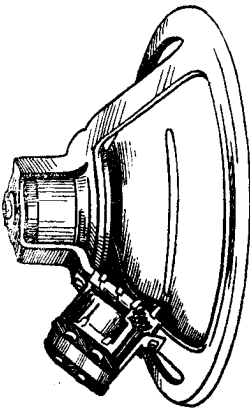

It may occur that the cost of a loudspeaker combination such as that shown above is not economically justified, in which case a good quality of reproduction can be achieved with the aid of the large loudspeaker shown here (diameter 32 cm). It reproduces both the lowest and the highest tones.

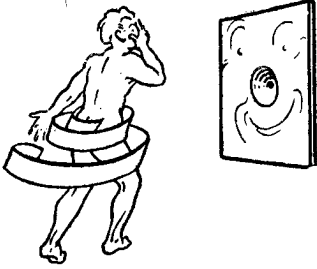

*"I'd better get behind the wall!"
says unclothed Mr. Loudspeaker.*

If the loudspeaker is only to be used for the reproduction of speech, a small cabinet is the best, e.g. for broadcasting personal calls in a factory. Although a small cabinet cannot handle the lowest tones, this is an advantage in this particular application since the sound will gain in clarity.

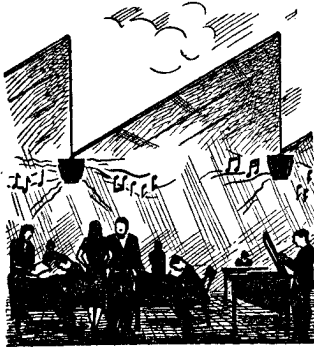

It is often necessary to adapt the form of the loudspeaker housing to the form of the building. In some cases it is desirable for the sound to be radiated both in a forward and in a backward direction. In a workshop, for example, the loudspeaker may be suspended in the centre.

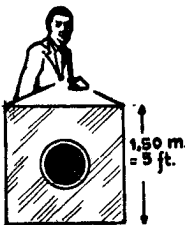

If the qualities of a good loudspeaker are to be used to the best advantage, in order to ensure the best possible reproduction of both the treble and the bass tones, the loudspeaker cabinet should fulfil the most stringent requirements. Hence, it should be carefully established in each case what quality of reproduction is required to give satisfactory results.



With open-air installations care should be taken that the sound is not "blown into the sky". Moreover, the loudspeaker should be adequately protected against the effects of the weather.

An interesting piece of equipment is the "circophone". With a 10-watt loudspeaker unit suspended at a height of five metres perfect intelligibility within a radius of from 20 to 25 metres is guaranteed, even in busy traffic.

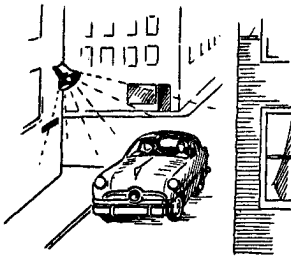

Horns are also used a great deal. A valuable feature of the horn is that the sound is beamed. As a result the sound in the beam is 5 decibels stronger than when the same loudspeaker is mounted on a baffle.

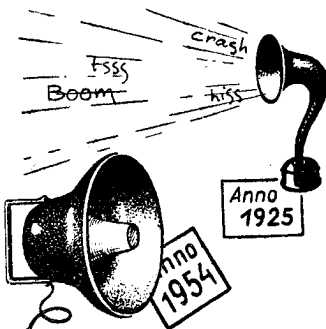

It is clear, therefore, that in many cases the application of a horn-type loudspeaker is to be preferred. The design of the modern horn has very little in common with that of its predecessor, which some of us will remember from the early days of radio.



The Philips re-entrant horns were especially designed for public address systems, which should combine good intelligibility of speech with large volume. The performance is still perfect even at a distance of a few hundred metres.



The horns are weatherproof and can, therefore, be used in the open air in all weather conditions without any risk of damage. They are particularly suitable for police and fire-guard purposes.

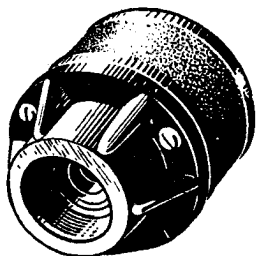

Pressure-chamber type of 10 W.

The driving unit used in re-entrant horns is of a special diaphragm type of 10 or 20 watts. It has a very small diaphragm, which — thanks to the horn — produces an enormous volume of sound. The unit is simply screwed on to the horn.

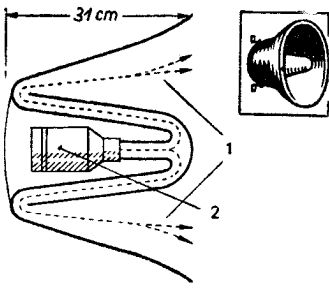

The greater the acoustic length of the horn, the better its performance. A certain Philips horn is so designed that, with an actual length of only 31 cm, it has an acoustic length of no less than 74.5 cm.

1 = sound-path having a length of 74.5 cm. 2 = loudspeaker.

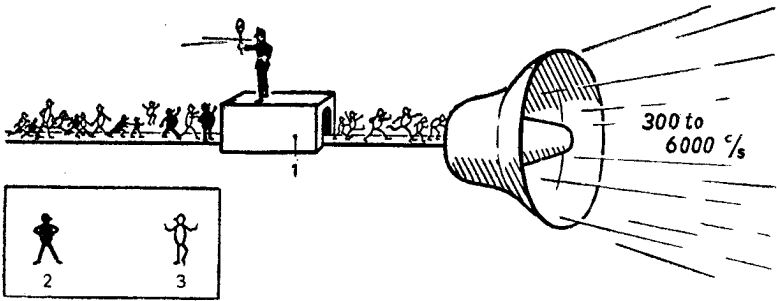

1 = low-tone filter 300 to 6,000 c/s. No entry for tones under 300 c/s.
2 = low tones. 3 = high tones.

The speech intelligibility is better when the deepest tones are suppressed. This loudspeaker has therefore been equipped with a device which is known as a "bass filter". The bass filter cuts off all tones with a frequency below 300 c/s, so much that troublesome background noise is also eliminated.



The high efficiency of the diaphragm driving unit should be largely ascribed to the exceedingly high magnetic field strength in the air gap. This field strength is 15,000 gauss. What this means will be briefly explained below.

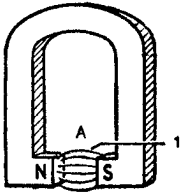

A = weak magnet with low flux density (1).

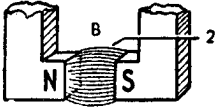

B = strong magnet with high flux density (2).

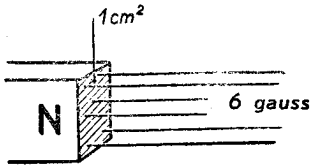

6 flux lines per sq.cm.

The power of a magnet is determined by the number of lines of flux which travel from one pole to the other. The greater the number of lines of flux, the greater the flux density (which is expressed in "gauss") and the more powerful the magnet and its magnetic field.

With six lines of flux per square centimetre the flux density is 6 gauss and with 1,000 lines of flux per square centimetre it is 1,000 gauss.

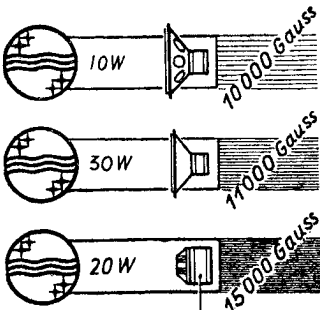

Pressure-chamber type.

This illustrates the enormous flux density in the air gap of the Philips loudspeakers, in which a special type of magnetic steel, called "Ticonal" steel, is used for achieving great field strength.

Matching

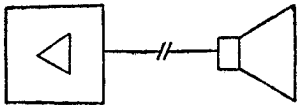

sible, i.e. at full load. The various measures taken to achieve this come under the heading "Matching".

In the case of an installation comprising one amplifier and one loudspeaker the matter is fairly simple. It is stated on the amplifier what the impedance of the loudspeaker should be. The loudspeaker should be capable of handling all the energy that the amplifier can furnish. Its rated power must therefore be the same as the rated power of the amplifier.

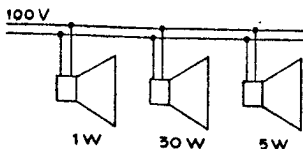
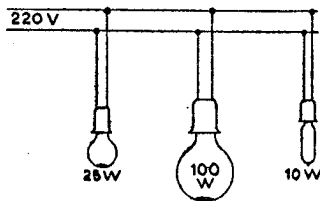
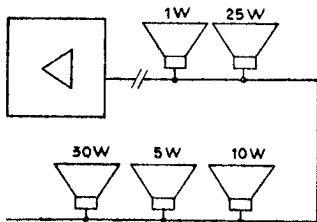

Each loudspeaker in an installation should receive so much power that it just produces the volume of sound required for the area which it is intended to cover. Furthermore, the amplifier should be operated as economically as possible,

The problem is more difficult, however, when a number of loudspeakers are to be connected, all requiring different quantities of power.

The modern method of connecting loudspeakers is the same as that employed for connecting electric light bulbs to the mains supply. The amplifier has a maximum output voltage of 100 volts (in the U.S.A. 70 volts) and the loudspeakers are so designed that at 100 volts they absorb exactly their rated power. To this end the loudspeakers are equipped with a 100-volt transformer.

The loudspeakers can now all be connected in parallel and each will receive the share of power to which it is entitled.

The total rated power of the loudspeakers may not, of course, exceed the rated power of the amplifier. The power of the loudspeakers connected to a 70-watt amplifier should, therefore, total 70 watts, i.e. for example fourteen 5-watt loudspeakers, thirty-five 2-watt loudspeakers, etc.

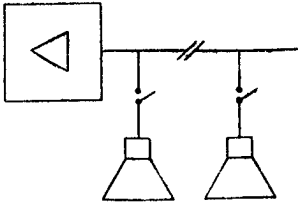

It is often necessary to be able to switch off the loudspeakers individually, as for instance in a hotel with a loudspeaker in every room.

With modern amplifiers this is no drawback, as the application of negative feedback enables the amplifier to function quite satisfactorily even if it is required to drive only a single small loudspeaker.

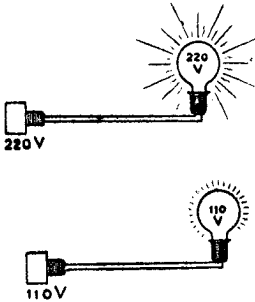

If an electric lamp rated for 220 volts is connected to a mains supply of 110 volts, it will probably use less current, but it will also give much less light.

If a loudspeaker is connected to a voltage lower than its rated voltage, it will use less current and still produce a fairly large volume of sound.

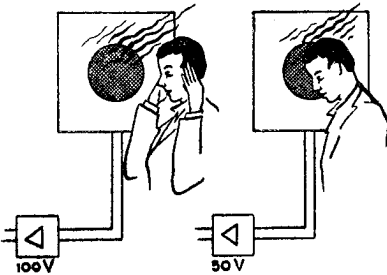

If a 100-volt loudspeaker, for example, is connected to 50 volts, its current consumption will drop by one quarter. Thus four times as many loudspeakers can be connected. The volume of sound will drop 6 db, which in most cases will not even be noticed. For this reason the output voltage of modern amplifiers can be varied.

With a large installation it is often desirable that only one type of loudspeaker should be used. Yet the volume of sound in a workshop must be greater than, for example, in an office. For this reason modern loudspeakers are equipped with a tapped matching transformer, by means of which the volume of sound can be reduced.

E: Demonstration of public-address and music installations

I. Preparations for a demonstration



*"Above all, Gentlemen,
have no fear!"*

It stands to reason that the layman will experience a certain feeling of anxiety in connection with the whys and wherefores of electro-acoustic installations. There is no need for such anxiety, since the real problems have all been solved beforehand by the Philips engineers and technicians who design the equipment. They have made allowance for the fact that the installations will sooner or later be operated by a layman, who may be an innkeeper, a leader of a dance band, a sidesman in a church, a clerk in an office or a worker in a factory.

All the salesman has to do is to convince the prospective client — with a certain feeling of pride — of the first-class performance of Philips equipment. The few tricks of the trade required are soon learnt and after a few attempts even the assessment of "difficult cases" will no longer present any serious problems.



It is an essential requirement that the subject be approached with a certain amount of enthusiasm, which in any case will gradually grow in view of the interesting subject matter involved. The salesman should improve his technical knowledge in his spare time, even though he does not intend to become a fully-fledged radio technician.



In practice a feeling of self-consciousness will soon develop, since a well-conducted demonstration will give the prospective client the impression of being in the presence of a modern magician. The salesman's task is made easy, because all Philips products are finished in every detail before being brought on the market. It would be a good deal more difficult if they were of inferior or indifferent quality, so that they would have to compete with better products

of other makes. The salesman can be sure that the goods he offers are the best on the market and he need not fear competition, provided he does not make silly mistakes.

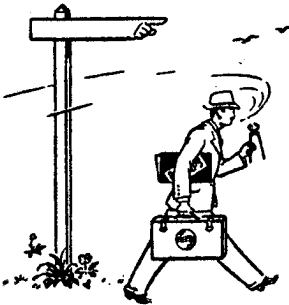

One need not be a qualified engineer to demonstrate a Philips amplifier installation. It does not take long to learn how to assemble and operate the equipment. There is no need to feel anxious about the technical side of the work.

The preparations for a demonstration should be regarded as a serious matter and should be given careful attention, since ultimate success largely depends on the efficiency with which this work is carried out. The rest is simple. The following hints will be found useful in this connection.

First of all it is essential to know exactly what the client wants. It will be fairly simple to decide what is required during a preliminary discussion with the prospective client, and after inspection of the location. The answers to the following questions should be noted.

1. For what purpose is the installation to be used?

Should the quality of reproduction fulfil particularly stringent requirements or is the installation only to be used for the reproduction of speech? In the latter case perfect intelligibility is of primary importance.

The following possibilities may be encountered:

- a. Reproduction of radio broadcasts in other rooms.
(purely local reception or also long-distance reception?)
- b. reproduction of gramophone records.
- c. reproduction of speech.
 - in the same room
 - from one room to one or more other rooms
 - amplification, for example of a speech, a lecture or an address, in large halls or in the open air
 - broadcasting messages (in offices for example), calling individuals, passing orders
 - announcing at concerts or in cabarets
 - improvement of acoustic conditions in large halls.
- d. reproduction of original musical performances
 - amplification in the hall itself
 - in other rooms or in the open air
- e. combinations of any of the cases mentioned above.

2. What is the nature of the space in question and for what purpose is it used?

- a. size of the rooms concerned (to be measured)
- b. purpose for which the rooms or the halls are used (office rooms, hotel rooms, dining-rooms, classrooms, restaurants, factory workshops, assembly rooms, etc.)
- c. acoustic conditions.

3. Is the installation to operate in the open air?

- a. what is the area to be covered?
- b. how many people can it accommodate?
- c. should echo and reverberation effects be taken into account?

4. How much money does the prospective client wish to spend?

The answers to these questions will make it possible to form an idea of what can be offered and can, moreover, be used as a basis for the preparatory work in connection with the demonstration, i.e. for assembling and demonstrating the equipment and accessories required.



There are a number of Philips publications and operating-instructions which will help the salesman in the necessary preparatory measures. He can then see what equipment is available, study the technical problems involved and consider prices. If necessary, he can consult more experienced colleagues or, better still, the Philips experts.

Three examples will give an impression of how to proceed.

Example 1

An installation for amplifying the output of a radio receiver is to be made in a restaurant with a number of rooms of average size. The receiver available is of good quality but incapable of producing the required volume of sound. The loudspeakers should be as inconspicuous as possible. The mains supply is 220 volts A.C. (The information furnished by the client, regarding the available current and voltage, should invariably be checked!!)

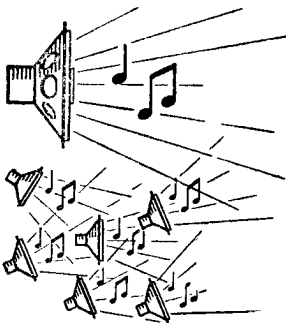

A number of small ones better than one large one.

of the room. For acoustical reasons it is always advisable to use a number of small loudspeakers instead of one large loudspeaker; in other words the sound energy must be divided over the room.

A suitable amplifier would be the 20-watt amplifier type EL 6400, which should be adjusted for use on 220-volt mains beforehand. To ensure a good bass response, 5-watt loudspeakers in cabinets measuring about 12" × 16" must be provided. The noise level in a restaurant is relatively low, so that a smaller volume of sound will be required than in, for example, a noisy public house. The number of loudspeakers required is determined by the size

It is advisable to incorporate a gramophone in the demonstration programme, as it is much more suitable for carrying out the initial tests than an unfamiliar type of receiver. Moreover, it is quite possible that the receiver in question may not be free from interference, and a demonstration with crackling noises is never very convincing. The demonstration of the gramophone may even persuade the client to purchase such an instrument (Philips automatic record changer!). When records for the demonstration are selected, preference should be given to solo music and "mellow" instruments, such as the accordion, violin, cello and organ. Orchestral music and soprano voices impose higher demands on the reproduction. (Do not forget the necessary leads for the gramophone.)

To be on the safe side: the various apparatus should be tested and connected up provisionally before they are taken along to the client. It gives a pleasant feeling to know that everything is in good working order, and the demonstration will be all the more successful.

The various materials, tools, etc. that should be taken along are listed further on.

Example 2

A medium-size public house is to be equipped with an installation for the reproduction of radio broadcasts and gramophone records. The installation should also be suitable for making announcements from time to time. The space involved comprises three medium-size saloons. Mains supply: 110 volts A. C.

A suitable amplifier is the Philips 20-watt amplifier type EL 6400, which should be adjusted for operation on 110-volt mains beforehand. The loudspeaker problem cannot always be solved at a desk and different models should therefore be considered, e.g. 2-watt and 6-watt loudspeakers. A suitable microphone is the EL 6010 model. Do not forget that the microphone is to be used on a table stand. It is advisable to have a Philips automatic record changer ready for operation.

For the rest the same preparatory procedure should be observed as for example 1.

Example 3

The workshops of a factory are to be equipped with an installation suitable for loudspeaker reproduction of radio broadcasts and gramophone records. The installation

should, moreover, be suitable for covering a yard closed in on three sides by the factory buildings. Further, it should be possible to make announcements from the amplifier location. Mains supply: 220 volts A. C.

A suitable amplifier is the 70-watt amplifier type EL 6420, which should be used with the Philips moving-coil microphone type EL 6010. Loudspeakers: 6-watt or 10-watt type for example, in double slanting cabinets; in the open air: Philips horn type 9884 or the Circophone type 9883. The number and the type of loudspeakers can only be determined on the spot. In this case, too, the same preparatory procedure should be observed as described for example 1.

Any number of examples can be given. Only three are given here, to provide an impression of the general principles involved. The first visit to the client affords an opportunity of obtaining information concerning local conditions. It should be established how long the various lines will be, where mains connections are available, where a suitable earth connection can be made, etc. All these points are of the greatest importance to ensure the satisfactory performance of the installation. If necessary, the aerial of the broadcast receiver must also be inspected.

5. What is required for the demonstration?

The following is a brief list according to which the salesman can note during the first visit to the client such information as is required to ensure that nothing will be overlooked in the preparatory work for the demonstration.

Type of location: e.g. public house, restaurant, workshops, classrooms, etc.

Number and size of rooms: e.g. 4 rooms, of which two measure 32' × 64' × 9' and two measure 50' × 80' × 80'.

Make situation sketch!

Type of current: e.g. alternating current, 50 c/s.

Voltage: e.g. 220 Volts.

Mains outlets: note whether new wall sockets must be installed; whether long connection cables are required for the demonstration; number of cables required for connection to the mains; whether multiple plugs, etc. are required.

Earth connection: whether available; if necessary, note the materials required, such as earthing clamps, earth wire, plugs, etc..

Broadcast receiver: whether available and in good condition; if necessary, note what type of set should be provided.

Aerial installation: if necessary, note what materials are required.
Microphone: state type required.
Amplifier: e.g. 20-watt amplifier.
Loudspeakers: e.g. four 3-watt loudspeakers.
Gramophone: e.g. "available".
Records: make a selection.
Connection cables: state length and type of cable.
Spare tubes: note types.
Spare fuses: note type and number required.
Tools and auxiliary materials: e.g. pliers, screwdrivers, insulating tape, etc..
Miscellaneous: e.g. brochures, operating instructions, price lists to be taken along.

After a short time the salesman will have gained sufficient experience to enable him to make a suitable choice of the materials required. It is nevertheless advisable to complete the above list in each case, since it will constitute a valuable "aide mémoire" even for the most experienced salesman.

II. The demonstration itself

A first requirement is to keep calm, even when matters do not proceed as smoothly as had been expected. A second requirement is to remain polite. The client naturally knows everything better, and in any case he should remain under that impression. One of the delicate tasks of the salesman is to change the client's mind without his noticing it.

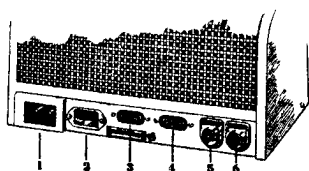

1 = mains connection. 2 = loudspeaker. 3 = receiver. 4 = pick-up. Between 3 and 4: earth terminal. 5 and 6 = microphones.

The 20-watt amplifier type EL 6400 has connections at the rear marked "microphone", "pick-up" and "radio". To avoid wrong connections being made, only the appropriate connectors should be used. The microphone cable, for example, has a special type of connector.

The connection to the broadcast receiver is made via the socket marked "R" and with the aid of the special three-prong plug provided for this purpose. To ensure correct matching, the receiver should have a low-impedance output.

The connection to the gramophone should be made in such a way that the core of the lead is connected to the left-hand contact and the screening to the right-hand contact. To avoid hum, the terminal marked with the "earth" symbol should be connected to a good earth point (water pipe).

The loudspeaker is connected to the appropriate socket on the amplifier (marked with the loudspeaker symbol) by means of the triple-pole plug provided. Usually the 100-volt position of the output voltage adapter is employed. This adapter is located on the output transformer. Most loudspeakers for use with amplifier installations are equipped with a transformer which is so designed that at 100 volts the loudspeaker just operates at full load.

In the United States the output voltage employed is 70 volts instead of 100 volts. The output voltage of Philips amplifiers can likewise be adjusted to 70 volts, so that they can also be used with American loudspeakers. Loudspeakers without matching transformers can also be used, but they should be connected in series. In this case the voltage adapter should be adjusted to a value approximately corresponding to the total impedance of the loudspeakers (in accordance with special directions for operation).

When discussing the merits of the Philips 20-watt amplifier with the client, who may raise queries in connection with competitive makes, the following two important features should be pointed out. High-grade microphones (such as moving-coil and ribbon microphones) can be connected direct to the amplifier. A special pre-amplifier, which naturally makes the installation more expensive, is not required. The amplifier is, moreover, equipped with facilities for mixing two types of sound reproduction, for example gramophone records and announcements.

We shall now revert to the actual demonstration. When all the connections have been made (care should be taken to avoid a tangle of wires, while nails and screws should not be used), a record is placed on the gramophone and started at low volume to establish whether everything is in order. Then the volume control is turned up (but not too far!). The installation should only be operated at greater strength at the special request of the client.

It is very important that the controls should not be continually readjusted while the record is playing. The setting of the volume and the tone control should be left unchanged until the end of the record. The client should be allowed to listen in peace. It can be quickly observed whether he is growing impatient. There will be time enough afterwards for explanations, which should be given calmly, politely and briefly by form, without going into too much technical detail.

After the gramophone records have been successfully demonstrated, the amplifier should be switched over on to "broadcast receiver" (tuned in to a local station). The special points referred to above

should also be observed in this case. If required, the microphone can then also be demonstrated. Always use a table stand or a floor stand. The microphone lead to the amplifier should be screened (special cable).

The microphones are equipped with a built-in, tapped matching transformer. If the standard microphone cable (which has a length of five metres) is used, the microphone should be adjusted so that the arrow points to "10,000 ohms". The microphone should not be specially earthed, since this is effected by means of the microphone cable via the amplifier.



The microphone should be so arranged that it is not in the sound-beam of the loudspeaker, since otherwise loud howling will result owing to acoustic feedback. This would not make a very favourable impression on the client.

For gramophone records the tone control should be adjusted on the "low" side (but not to the extreme position). This will reduce background noise. For speech reproduction the tone control should invariably be adjusted to its "highest" position.



Furthermore, care should be taken to ensure that the loudspeakers are not overloaded (volume control!). A 2-watt loudspeaker should not be operated on 5 or 6 watts. By way of comparison it will be clear that a mouth organ cannot produce the same volume of sound as a cinema organ; if it is blown too hard the music will be seriously distorted.

The question of accessories is very important, for the performance of the equipment can only be guaranteed when suitable materials are used. Philips accessories should always be recommended. The very weak voltages and currents often encountered (in the microphone circuit, for example) impose heavy demands on the quality of the connectors.

For this reason Philips manufacture a wide range of connectors, couplings and sockets, which have been designed to fulfil the stringent requirements of electro-acoustics. Despite the fact that these accessories are relatively expensive, they are being used more and more, because the performance of even the best equipment can be ruined by bad connections.

After a successful demonstration the salesman should strike while the iron is hot. If possible, he should clinch the deal on the spot, for this is after all the object of the demonstration. It is wrong to leave the installation with the prospective client for a number of days free of charge. Experience has shown that the client loses interest quickly if too much time is allowed to elapse.

A few words should be devoted to the subject of acoustic conditions, since they play a decisive part in electro-acoustics. It should be explained to the client that the quality of reproduction in an empty hall is different from that in a hall filled with people. In the former case the reverberation effect is greater. Thus, when used for a demonstration in an empty hall the equipment should be so adjusted that the volume of sound is not excessive. In a hall filled with people the volume should be increased, so that the background noise produced by the audience is drowned. The limits which should be observed in this connection are fairly flexible and must be determined by personal experience.

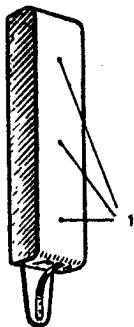

Philips Sound Column (4 built-in loudspeaker units).

For the purpose of improving the acoustic conditions in churches and in other locations which are unfavourable from the acoustic point of view Philips have designed special sound columns. A suitable arrangement of a number of loudspeakers ensures that the sound-beam is directed at the audience or congregation. With these sound columns the ratio of direct sound to reflected sound is more favourable. Experience has shown that even in spaces with a long reverberation time the use of sound columns ensures good intelligibility at the more remote points.

F: Transistors



Much has been published in the newspapers recently about transistors and semi-conductors. What exactly are they?

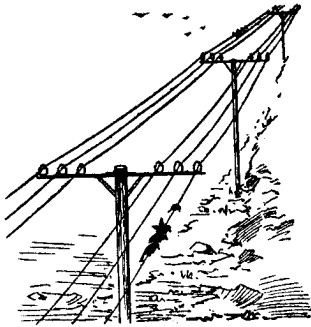

Conductors are substances, such as copper, which permit a ready flow of electrons. Insulators, on the other hand, are substances which do not permit the passage of electric current. Both types are found on a telegraph pole. The current flows through the copper wires and the insulators prevent the current from flowing to the pole and via the pole to earth.

The third type of substance is the so-called semi-conductor. As the name implies, a semi-conductor is a substance through which electric current will flow only with great difficulty. Substances of this type are classified in between the conductors and the insulators.

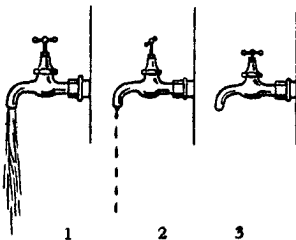

1 = conductor. 2 = semi-conductor. 3 = insulator.

Conductors, semi-conductors and insulators resemble the taps shown here. The conductor offers practically no resistance to the flow of current and resembles the first tap. The semi-conductor has a high resistance; the current leaks through, exactly like the water drips through a leaky tap; the insulator resembles a good closed tap: not a single drop of water passes.



A 10-ton truck load of zinc ore contains about 1 kg of germanium.

contains about 1 kg of germanium. It is refined to a high degree of purity in a large series of processes and formed into a small crystal. The crystal is mounted on a small holder and sealed in a glass envelope together with a metal spring wire, which presses on the crystal. This is the germanium diode.



Germanium diode.

hundred thousand ohms to one megohm. It can withstand a voltage of from 20 to 60 volts and cannot, therefore, be used as a mains rectifier in a radio receiver.

The most familiar example of semi-conductor is germanium. This is a rare element, which has the appearance of a metal. It occurs in zinc ores in very small quantities and is removed from these ores by chemical means. A 10-ton truck load of zinc ore contains about 1 kg of germanium.

The name reminds us of the diode tube. The germanium diode acts as a rectifier and, like the selenium rectifier, passes current in one direction only. This rectifier is very efficient, since a small diode can handle a current of 50 mA. The resistance in the current-passing direction is a few hundred ohms, whereas the resistance in the opposite direction ranges from a few

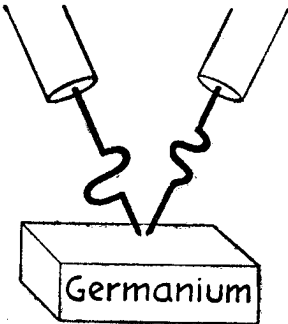

A transistor consists of a germanium crystal and two wires, which press on the crystal at points very close together.



This is a point-contact transistor. The remarkable thing is that the transistor actually operates as an amplifier. If a current flows between the crystal and one of the wires, an amplified current will flow between the crystal and the other wire.

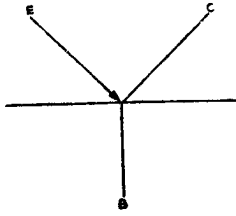

The graphical symbol for a transistor is shown on the left. The three connections are called:
 E = the emitter
 C = the collector
 B = the base.

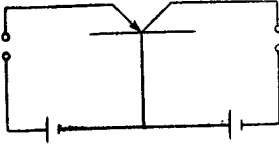

A transistor is always so connected that the emitter is positive with respect to the base and the collector negative in relation to the base.

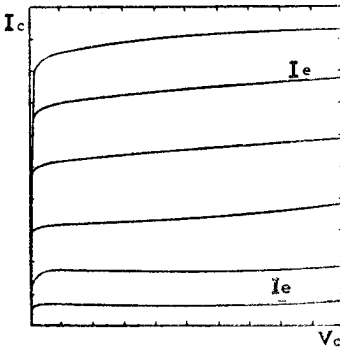

The most important characteristic of a transistor is that of the collector voltage plotted versus the collector current for several different emitter currents as parameter. This characteristic closely resembles that of an ideal pentode.

V_c = collector voltage. I_c = collector current. I_e = emitter current.

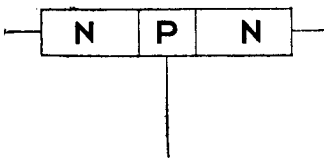

There is yet another type of transistor, which — technically speaking — is even more important than the point-contact transistor. It is the junction transistor, which consists of a germanium crystal comprising three separate, slightly different layers. Dependent on the construction, this transistor is either of the p-n-p or of the n-p-n type.

G: Television

In television a picture is transmitted from the studio to the receiver with the aid of aether waves, which are radiated by a transmitter, just like ordinary radio waves.

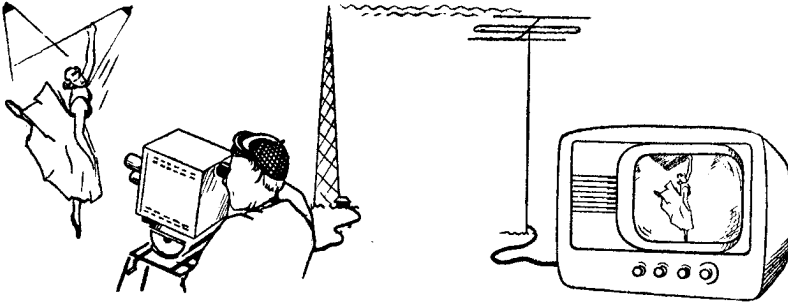

The following comparison will serve to illustrate the processes involved. If we want to know what a certain picture in a museum looks like without having to go there, we can ring the museum and ask for a description of the picture by telephone. We can then draw on a board what we hear on the telephone, but obviously the drawing on the board will not be at all like the original picture.

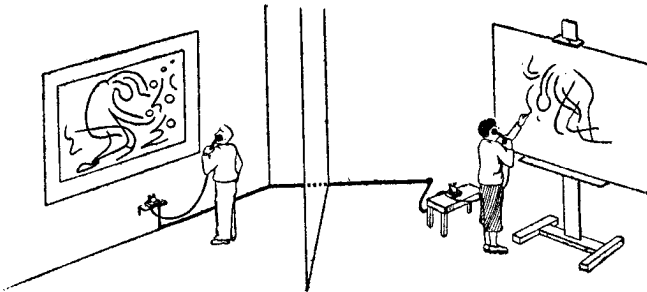

A better method is to arrange with the museum for a grid to be placed over the picture. A similar grid is then placed over the drawing board. We next receive an exact description of what may be seen in each square of the grid, which information is entered in the corresponding square on the drawing board. We start in the top left-hand corner and work from left to right up to the end of the first row, continuing with the second row, and so on. This gives a much better result, but the colours cannot be transmitted and we therefore replace the picture by a black-and-white photograph. The description of the squares given over the telephone will now be roughly as follows: white-white-white-grey-grey-grey-grey-black-black-white-white-black, etc. Clearly the definition of the picture will be better according as the mesh of the grid is smaller.

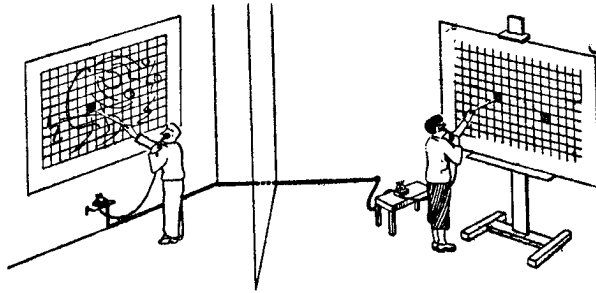

In the studio the television camera records the scene, which is then passed to the transmitter spot by spot. White, black and grey are translated into aether waves, which are transmitted in succession, likewise starting in the top left-hand corner and completing one line after the other until the bottom right-hand corner is reached. The picture is divided into a great number of lines, and the complete picture is transmitted so often that the different images merge into one moving picture.

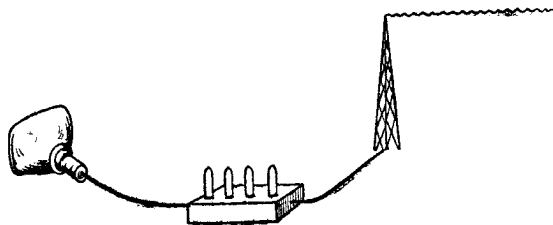

In the receiver the aether waves arrive in the same order of succession and are translated back into the shades white, black and grey. The receiver, too, starts in the top left-hand corner and records line by line what it receives from the transmitter.

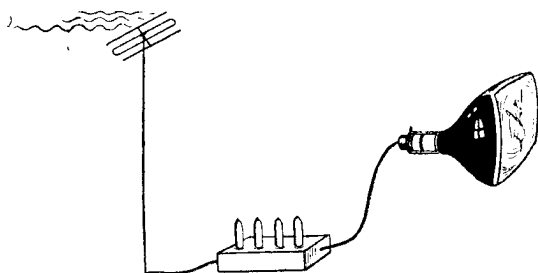

It is essential that the transmitter and the receiver both start at the same point and at the same time. To this end the transmitter sends a separate signal with each picture, which is not translated into light and serves to warn the receiver that it should start recording in the top left-hand corner. This is called "synchronization". The sound relating to the picture is transmitted separately by the same transmitter on a wavelength differing slightly from that on which the picture is transmitted. This enables the receiver to keep the two signals apart.

It is also possible to transmit coloured pictures. This is achieved by analysing the coloured picture into three pictures of a single colour. The individual pictures are then transmitted separately and a signal is sent to the receiver to indicate what colour it should show. Owing to the persistence of the human eye the three separate pictures together appear as the original coloured picture.

