

METCOMMUNICATOR

MICROWAVE TUBES AND DEVICES



VOL. 1, NO. 1

AUGUST 1963

CTPI

METCOM INC. — 76 LAFAYETTE STREET — SALEM, MASSACHUSETTS — TELEPHONE 617-744-8400 — TWX 617-744-5958

Wellesley J. Dodds New President of Elcon

Dr. Edwin Langberg, Chairman of the Board of Elcon Laboratories, Inc., Watertown, Mass., announced the appointment, effective May 1, 1963, of Mr. Wellesley J. Dodds as President of Elcon Laboratories, a wholly owned Research subsidiary of Metcom, Inc., Salem, Mass. Since December, 1961, Mr. Dodds has been Vice President of Engineering at Metcom, where he was responsible for all engineering projects. In his new position as President, Mr. Dodds will assume full responsibility for all functions of Elcon Laboratories.

Prior to joining Metcom, Mr. Dodds was Vice President of Engineering with Bomac Laboratories and has also been associated with Varian Associates and RCA in various engineering capacities. He was a recipient of the RCA Research Award in 1953 and holds approximately twelve patents on microwave tubes and circuits. Mr. Dodds is a Fellow of the IRE, and a member of Sigma Xi (Research), Sigma Pi Sigma (Physics) and Pi Mu Epsilon (Mathematics).

Mr. Dodds' extensive background in the electronic device field fully qualifies him as an excellent choice for his new position. He graduated from South Dakota College in 1938 with a B.S. degree with honors in Physics and Chemistry and Minor in Mathematics. In 1941 he received his M.S. in Physics and Minor in Mathematics at the University of Kansas. His pre-doctoral studies in Bio-Physics were conducted at the University of Illinois, 1941-42, and he was a member of the American Management Association's Executive Action Course in 1961.

Mr. Dodds received Teaching Assistantships in Biology and Physics at South Dakota, Kansas and Illinois during the years 1936 to 1942. He was Power Tube Design Engineer for RCA Tube Division

from 1942 to 1945, then became Research Physicist for RCA Laboratories Division in 1945, where he remained until 1954, working on microwave tube and circuits and special television receiving tubes.



Wellesley J. Dodds

In 1954 and 1955, he was Manager of Microwave Development at RCA Tube Division, and from 1955 to 1959, he was Manager of Wave Tube Development for Varian Associates.

In the latter two positions, he supervised applied research, advanced development and product design of microwave tubes, organized and built up technical staffs, directed technical sales and contract procurement, formulated associated budgets. From 1959 to 1961, he was a member and Secretary of the Varian Technical Policy Committee which established product improvement and new product directions, company wide.

At Bomac, Mr. Dodds' responsibilities covered research through pilot production of microwave, tubes, solid-state devices, atomic

(Continued on Page 2)

Microwave RF Assemblies Developed by Metcom

Discussion by David C. Broderick,
R. F. Assemblies

METCOM has recently demonstrated a capability in the design and development of microwave RF Assemblies, which are used and are intended to be used in radar systems and beacons, having found use in interplanetary space probes and applications such as beacons for guided missiles, aircraft and other areas.

These assemblies consist essentially of a power source, normally a magnetron, an Isocirculator which functions as an isolator for the magnetron, a Duplexer for the transient-receive signals, and Crystal or Receiver Protector which could be in a form of a gaseous TR or semiconductor limiter type of device or some combinations of these devices. More complex structures might also include filters, klystrons, local oscillators and mixers.

Since we incorporate in an assembly several components manufactured by METCOM, we have the advantage of being able to produce assembly characteristics which cannot be readily achieved using components purchased piecemeal and assembled separately.

One such assembly, which could perhaps be considered typical, is worthy of more detailed description and discussion, and will provide some in-sight into our capability in this area. This assembly has been given the METCOM part number MXD-12 and was designed for operation in X-band, incorporating a magnetron, an isocirculator and a gaseous TR tube for crystal protection. This device is of particular note since it is being used in a space application which requires very stringent performance.

Briefly, this package performance includes output power in X-Band of 1½ kilowatts in rather broad pulse.

(Continued on Page 2)

Wellesley J. Dodds -

(Continued from Page 1)

frequency standards, plasma and ferrite devices. He was also a member of the four-man Bomac executive committee.

As Vice President of Engineering at Metcom, Mr. Dodds has been responsible for all aspects of research, development, engineering and pilot production of klystrons, beam tubes and associated devices. He also served as a member of the management committee and as such was available as a consultant and project leader to other departments at Metcom.

Mr. Dodds' other activities include: Past Member and Chairman,

IRE Committee on Electron Devices . . . Past Committee Member and Chairman, AIEE-IRE Annual Conference on Electron Tube Research . . . Past Member IRE Standards Committee . . . Past Member, Administrative Committee of IRE Professional Group on Electron Devices . . . Member of IRE Professional Groups on Electron Devices, Microwave Theory and Techniques, Engineering Management, and Education . . . Chairman, Working Group on Microwave Devices, Advisory Group on Electron Devices, Department of Defense . . . and a Contributor to the Panel on Electronics, Materials Advisory Board, National Academy of Sciences.

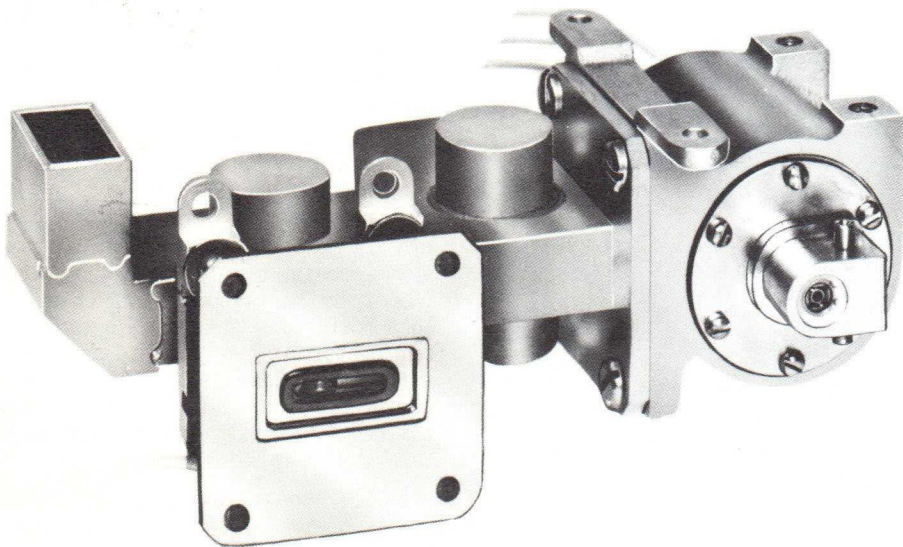

MXD-12

RF Assemblies -

(Continued from Page 1)

Frequency stability is a very important criteria and is maintained both as a function of temperature and other environmental factors such as vibration.

TR leakage energy is maintained at an exceptionally low level, and recovery time is on the order of less than $6\mu\text{sec}$. The receiver loss through the antenna arm of isocirculator and the TR structure is less than 1db.

The isocirculator provides approximately 40db of isolation between the magnetron and the antenna. This serves to protect the magnetron from any mismatch occurring at the antenna and, con-

sequently, to insure frequency stability as a function of low variation.

The isocirculator also serves to direct the signal from the magnetron to the antenna and to direct the echo signal received from the target back into the receiver system with minimum loss.

Since this particular assembly is intended to be used in an interplanetary space probe, environmental conditions become extremely important. To satisfy the requirements of these space conditions, though awkward and somewhat difficult, testing has been accomplished to demonstrate that the assembly has the capability of satisfying these requirements. Included are such unusual tests as a sterilization procedure, which is a soak at

a high temperature, namely 125°C , for a period of approximately 3 days. This high temperature soak includes cycling from room temperature to the hot temperature and back at least twice during this long interval. More typical environmental conditions such as vibration, are also performed on each and every one of these assemblies. The assembly is vibrated in each of three mutually perpendicular planes and performance is monitored before and after vibration to insure that no adverse affect has occurred on the operation of the device. Another space condition which is rather unique to this structure is the ability to perform in a vacuum. The device has been tested at a pressure of 10^{-6} millimeters of mercury and coincidentally at temperatures varying from approximately room temperature to -40°C for performance, and has been found to be capable of providing essentially the performance which was outlined early in this discussion. Of course, the life of the assembly is also an important criteria and this has been measured. All units were life cycle tested over a period of approximately 2 weeks. The units were operated on and off every half hour during this time interval and the performance was monitored at regular intervals. The device was demonstrated to be capable of performing under these conditions for this period of time.

Crossed Field Devices

by Jean Dulac, Chief Engineer
of Crossed Field Devices

Crossed field tubes, commonly called "M" type devices, are characterized by an electron current flowing across an electric field which is perpendicular to the magnetic field. The electrons travel from the cathode toward the anode and give up energy to the rf circuit (anode) in the interaction space.

Metcom, Inc. has been active in the magnetron field since the start of the company's operation.

Fixed tuned and dielectric tuned oscillators have been successfully fabricated for various system requirements. Magnetrons have been designed and developed in the S, C, and X bands with powers up to 10 kilowatts peak. Current programs in the Ku band with peak powers of 2 to 4 kilowatts are well in the development stages.

(Continued on Page 3)

The Metcom Klystron Line

by Louis W. Roberts, V. P. Research and Development

Metcom, Inc. has been active in the klystron field since its very beginning in 1959. Over the four year span, more than 65 different tubes have been developed primarily in X and Ku band. There are, however, a few types in C and K band.



Standard Metcom Klystron

Four distinct categories or classes may be noted among the Metcom types. They are (1) grid tuned reflex tubes, (2) external cavity tuned reflex tubes, (3) dielectrically tuned reflex tubes, and (4) stable fixed tuned two cavity power tubes.

The grid tuned reflex tubes vary in power output between 20 and 500 mw. depending upon the specified beam voltage and current and upon the mode of operation. All of the tubes in the Metcom line are waveguide coupled and utilize either mica or ceramic as a waveguide window element. Tuning is accomplished by varying the grid capacity in the capacity loaded klystron cavity. By utilizing various modes and the utmost in grid capacity variation, tuning capability in excess of 40% is possible with some types. On these types (i.e. MXK-26) micrometers are utilized so that a rough calibration of frequency vs. micrometer reading may be provided. Electronic tuning (accomplished by varying the repeller voltage) is of the order of 30 to 40 megacycles.

The second class of tubes, namely the external cavity tuned types utilize fixed grid positions. No distortion of the grid gaps occurs in the tuning operation. Instead tuning is accomplished by varying the frequency of a very closely coupled high Q cavity, which is a part of the basic tube assembly but not a part of the vacuum tube envelope. Typical of this family of tubes is the 6975/MXK-21. Most of these tubes

are in the low power end of the power spectrum and find their principal usefulness in local oscillator and test equipment service. The external coupled cavity acts as a frequency stabilizing element in addition to providing the tuning capability.

The third class of tubes or dielectrically tuned tubes are the result of a proprietary development of Metcom and sponsored by its own funds. Tuning is accomplished by varying the position of a dielectric rod with respect to the capacitive gap. Tuning ranges as great as 12% are conveniently accomplished in those tubes incorporating welded bellows. Tuning life in these types is several million cycles. Other tubes utilize convoluted bellows configurations and provide roughly 5% tuning range with proportionately lesser bellows life. The tubes are reasonably rugged and find their principal usefulness as parametric pump tubes. Power outputs of 0.5 to 1.0 watt are typical. One "off-



MXK-30
New Dielectrically tuned Klystron

shoot" of this general class of dielectrically tuned tubes is one incorporating very low input power (less than 4 watts). Principal application for this class is for space satellite local oscillator use, where power input is at a premium. Typical output power is of the order of 10 milliwatts. Of the 4 watts of input power required, roughly 1/2 is consumed in the heater and the rest is in the beam.

The fourth and final class of tubes is the two cavity medium power oscillator tubes. The tubes are fixed tuned within a tolerance of less than 0.001%. They feature very low noise output, low heater ripple noise, in-

sensitivity to magnetic effects and excellent frequency temperature stability.

The tubes are extremely rugged and are both convection cooled and liquid cooled, depending upon the power dissipated in the cavity block. Power outputs of 1 to 15 watts are available with beam voltages varying from 1500 to 3000 volts. Principal use of the tube is in CW Doppler systems for helicopters.

Crossed Field Devices -

(Continued from Page 2)

Capabilities exist in various types of output terminations; TNC coaxial output terminations utilizing cavity coupling loops, and waveguide outputs with ridge waveguide matching sections are standard techniques at Metcom.

Metcom Magnetrons are compact in construction. The magnetrons vary from 7 to 18 ounces in weight depending on the frequency and magnetic field requirements. The tubes, cylindrical in shape, have a diameter of 1 1/4 inches, in lengths as small as 2.575 inches. Other packages are of 3 x 3 x 2.75 inches. Frequency-temperature coefficients are under .04Mc/°C in C band, and compensated tubes in X band are under .03Mc/°C, and KU band .130Mc/°C in the temperature range of -55°C to +90°C. The tubes are rugged and capable of taking over 30G vibration from 5 to 2000 cps. Shock levels are well above 200g.

Recently new technical capability has been added to the Metcom know-how in the form of BWO's. BWO's are backward wave oscillators usually with a delay line of the interdigital type, which has the capability of broad band operation by varying the tube voltages. The voltage tunable crossed field devices are particularly attractive in that the frequency band can be voltage swept and that the power output remains essentially flat across the tuned band of operation.

Crossed field tubes incorporate two main types of cathode emitters; re-entrant and non-re-entrant. Magnetrons are built with re-entrant cathodes (continuous emitters). The "M" BWO's are fabricated with non-re-entrant type of emitters. The BWO guns are usually called injection type guns and they are physically mounted outside of the interaction space.

Quality Control

by Ralph C. Fairchild, Supervisor Q. C.

In November of 1961, METCOM, Inc. successfully passed all the requirements necessary for the establishment of the Reduced Inspection Quality Assurance Plan (RIQAP), as outlined by various military quality control specifications and directives, and was accepted as a high quality military supplier under the terms of this program. Metcom is proud to have been selected as a RIQAP supplier to the United States military establishments. We, at Metcom, feel this confidence from the military exemplifies more than any words the actions necessary to establish the high level of quality achieved.

Metcom has established a hard hitting quality conscious production

and engineering high vacuum tube facility fully supplemented by qualified and fully trained quality control personnel. The resulting combination has produced high vacuum tubes exhibiting MTBF statistics as good as any in the industry and vastly superior to most.

To maintain the high standards selected for its quality control and to continue to push for even higher standards, Metcom has placed full responsibility in its Quality Control Department for vendor qualification and review, in process quality standards and final electrical and mechanical quality acceptance.

It is the credo of Metcom quality control personnel that "The customer must be fully satisfied". Following this principle Metcom can offer high vacuum tubes to its customers second to none in performance and useability.

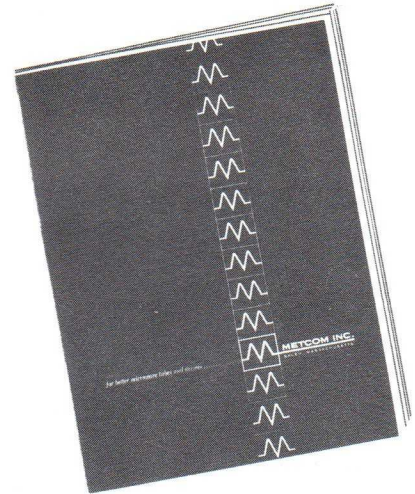

Please write us for full details and listings of our complete line . . . and 1963 Catalogue.

Visit our booth, #4324, at Wescon.

U. S. ARMY ELECTRONICS MATERIEL AGENCY

225 SOUTH EIGHTEENTH STREET
PHILADELPHIA 3, PENNSYLVANIA

IN REPLY REFER TO
SELMA-

9 APR 1963

Mr. Richard J. Broderick, President
Metcom Incorporated
76 Lafayette Street
Salem, Massachusetts

Dear Mr. Broderick:

The Army Electronics Command Reduced Inspection Quality Assurance Plan for TR and ATR Tubes has been in operation during the year 1962 at your facility.

The continuance of operations under R-I-Q-A-P for this period was predicated upon the ability of your managerial and production personnel to maintain a high product quality. This not only justifies our original evaluation of your company's quality control system but also reflects credit upon the personnel who have contributed to the success of the program.

It is always a pleasure to express our sincere appreciation for such a fine achievement.

Sincerely,

ALLEN T. STANWIX-HAY
Brigadier General, USA
Commanding



Metcom's Quality Control in Progress

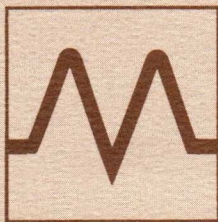

METCOMMUNICATOR

MICROWAVE TUBES AND DEVICES

January 1966

METCOM INC. • 76 LAFAYETTE STREET • SALEM, MASSACHUSETTS • TELEPHONE 617-744-8400

INCREASED BACKLOG TRIGGERS EXPANSION

The order-backlog, which has more than doubled this year, has justified physical expansion of the plant and facilities at METCOM. Acquisition of the Whitten property across the street from METCOM will add 15,000 square feet to the home base and will make possible a number of production benefits. This will make an immediate increase of about one-third of the in-house capability in machine shop requirements for pilot parts, jigs, fixtures and tools. It will allow quadrupling of the in-house space for expanding high power test facilities. (See catalogue) In addition to this acquisition, construction of a new addition to the main building for housing expanded plating facilities and a new chemistry laboratory facility has been started. This will permit a quick-reaction capability of METCOM, a factor that assumes greater importance every day with military demands increasing in all parts of the world. Another little bonus included also is increased parking convenience for customers and visitors in back of the new Whitten building. These new facilities increase METCOM's total floor space available to 96,000 square feet.

CATALOGUE FEATURES FACILITIES INDEX

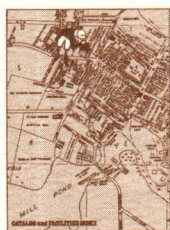

The new METCOM Catalogue is the most complete reflection of the products and facilities of the company ever offered to the industry. In addition to all the standard products that METCOM has been supplying to its customers, it lists the current modifications devised by METCOM engineers to resolve specific engineering conditions involving the entire range of power tubes, gas switching duplex-er tubes etc. The handsome new catalogue incorporates a facilities index supplement that dramatically displays the capability of METCOM to manufacture and to simulate operational conditions of components and test products in depth before delivery. Early distribution of the new catalogue will be made to customers and the industry. In the event your copy has not arrived a memo or call to METCOM will bring one by return mail.

UPGRADING THE PROFESSIONAL QUOTIENT

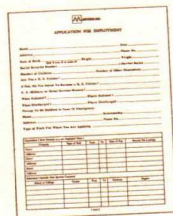

The search for professional competence is a constant factor throughout the electronics industry. This factor is a source of strength and weakness in all areas where there is a concentration of electronic manufacturers. METCOM has attempted to be selective by adding to its professional family only known experts in the areas of its product lines. Two new additions to our staff are Oley Cunningham and David Hobbs who will work with our Power Tube Division. They will concentrate on diversifying our line of high power tetrodes and magnetrons that has begun to assume an ever-greater role in the METCOM productivity pattern.

SUPPORT FOR THE TROOPS AT METCOM

Lights have been burning brightly for long hours at METCOM, Derby Street in Old Salem in recent times. The fact is that any company that expects to participate in Department of Defense contracts has to be prepared for special demands — and also must have an immediate response ready as standard-operating-procedure. This is referred to in the trade as a quick-reaction operation or QR House. It does not mean that the original orders may not be adequate, it usually means that the products did not reach their area of requirement on time due to shipping or other logistical reasons. At times, duplicate orders are required immediately, if not sooner. This is an expensive operation and requires extra work, expense and particularly foresight. METCOM is rapidly becoming known as a quick-reaction house (within its special capabilities) and the staff and crew feel that whatever sacrifices that are required will be compensated for in personal satisfaction gained as a contribution to the men overseas who are asked for so much.

FOOTNOTE TO HISTORY AT METCOM



For the past several years the institutional and product advertising at METCOM has been associated with 17th and 18th Century colonial customs, historical notes, artifacts and ingenious applications of Yankee horse sense to resolve problems or to satisfy a need. The examples cited have, more often than not, been found in the life and mores of old Salem or old Massachusetts Bay settlements and have been related to similar solutions of 20th century applications in the electronics industry. That the series has attracted more than average interest and readership is attested in the five citations awarded for individual insertions by the leading publications in the microwave field. The considerable historical research necessary to make these presentations completely authentic has resulted in a sort of bonus. An eminent contemporary historian, George Willison, disclosed in his book, "Saints and Strangers" that the original Indian name for the notorious King Philip of King Philip's War, the son of the great Massasoit, was METACOM. Quoting Willison, "Massasoit was succeeded by the oldest of his sons, Wamsutta. Accompanied by his next brother, METACOM, the chiefs went to Plymouth to renew the treaty. That done, they were given Christian names . . . Wamsutta was called Alexander, METACOM became Philip . . . who succeeded as chief on the death of his brother." The arm of historical coincidence is long and no one is reading anything into the original name of METCOM or Microwave Electronic Tube Co. of Massachusetts and Metacom. Actually the closest we can come to a tie-in with King Philip would be Phil Bagnell, our sales manager, and that's pretty far out.

AN/SPS 40, NEW CONCEPT IN COMPONENT ASSEMBLY

Not all the advances in electronics are based upon physical sciences or chemical reactions. Other factors including the time element, convenience and reliability in operation contribute toward the ultimate goal: successful operation under the worst conditions prescribed in the customer's specifications. When all of these conditions are met and tested performance proves to be well above previous norms AND when two or more systems are delivered as a tested package, it is obvious that the concept is going to set patterns for future operations. This is just what is happening at METCOM currently. Metcom is presently marketing AN/SPS 40 radar integrated and pre-tested package of components for original equipment, a high power coaxial switch plus a balanced coaxial duplexer and high power coaxial load and a high power very low loss low pass filter. The advantages of this type of delivery to the manufacturer of original equipment, in simple time and convenience alone, are tremendous although it places greatly increased responsibilities for testing and performance on the supplier; the concept of marketing integrated and tested packages to manufacturers by component suppliers is staggering in its possibilities for those companies who have the capability to carry this out. At the present time METCOM is in the vanguard of what may prove to be the pace-setting trend in marketing in 1966.

COME TO METCOM: BRING YOUR WIFE

Good news for those customers, buyers, manufacturers representatives and government officials who visit METCOM personally at some time during the year, is that Old Salem has been named a National Maritime Site and the facilities for antique buyers, historians, artifact-seekers, etc. will be greatly expanded. Undoubtedly the actual Federal homes and internationally known sights in Salem like the Witch House, House of Seven Gables and the collections of the local museums offer greater incentives to the real antiquarians than the rebuilt replicas of colonial settlements such as Sturbridge Village, etc. (This does not mean we are saying your wife is an antique). For shoppers, who seem to favor the carved and colored spread eagles, gatepost pineapples and wrought iron artifacts, the picking will be better than ever. When you visit again, bring your wife and family.

How Much Protection?

Indian Burn Out to Diode Burn Out

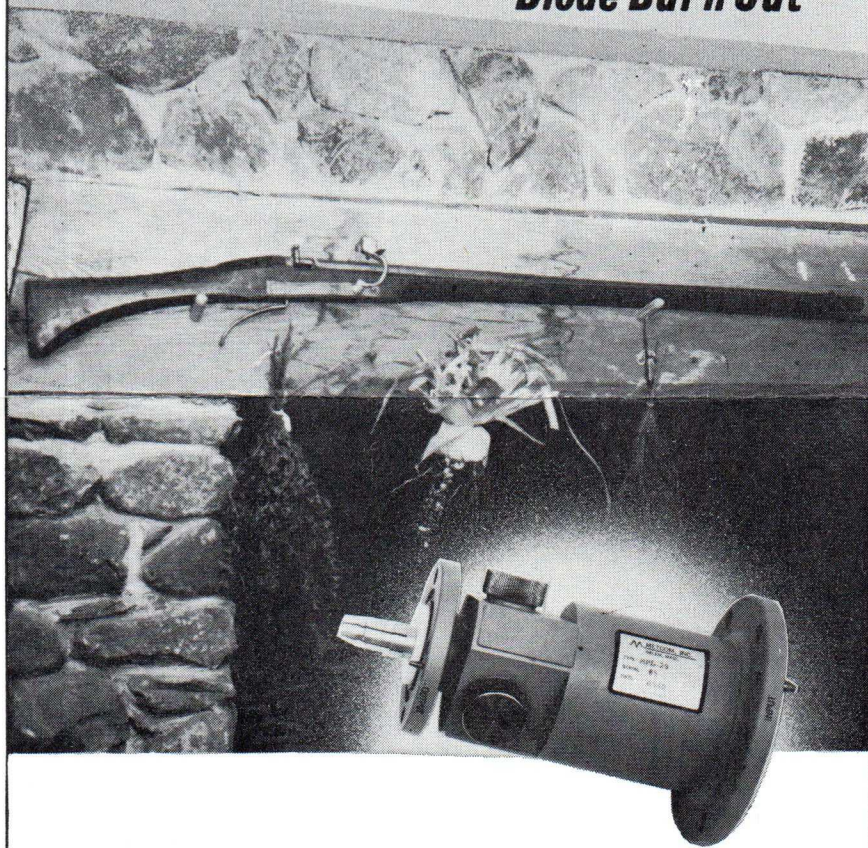

The Settlers of 17th Century Salem found themselves faced with staggering problems, not least among them, the possibility of Indian attack. Many methods such as dogs, watchmen, and geese in the attic were used to warn settlers of impending attack. However, the settler's real protection was the single-shot, smoothbore muzzle loader usually found over the fireplace. It was the muzzle loader that provided the protection necessary to survive in that new and hostile environment.

Today, in Salem, METCOM offers its customers a similar margin of protection for radar receiver circuits with SOLID STATE DIODE LIMITERS that are designed to reduce the spike leakage energy from the duplexer into the sensitive parametric amplifiers used in today's receivers. METCOM'S comprehensive testing produces SOLID STATE DIODE LIMITERS with unusually high reliability and exceptionally long life.

A new Technical Publication on Diode Power Handling Capabilities is now available . . . Please write: Metcom, Inc., Salem, Mass.

NAT SAYS:

*"Buy Metcom
Solid State
Diode Limiters"*



NAT B. METCOM

METCOM'S
INFORMATIVE
KLYSTRACHAUN

This Metcom Ad will appear in the...

January issue of *Microwaves* and
the February issue of *Microwave
Journal*

This ad was prepared to offer to Solid State Limiter users a comprehensive report prepared and published by Harold Heins in the January issue of *Microwaves* covering the predictable burnout levels of PIN and Varactor diodes under pulsed or CW conditions



METCOM INC.

SALEM, MASSACHUSETTS

microwave tubes and devices

for better

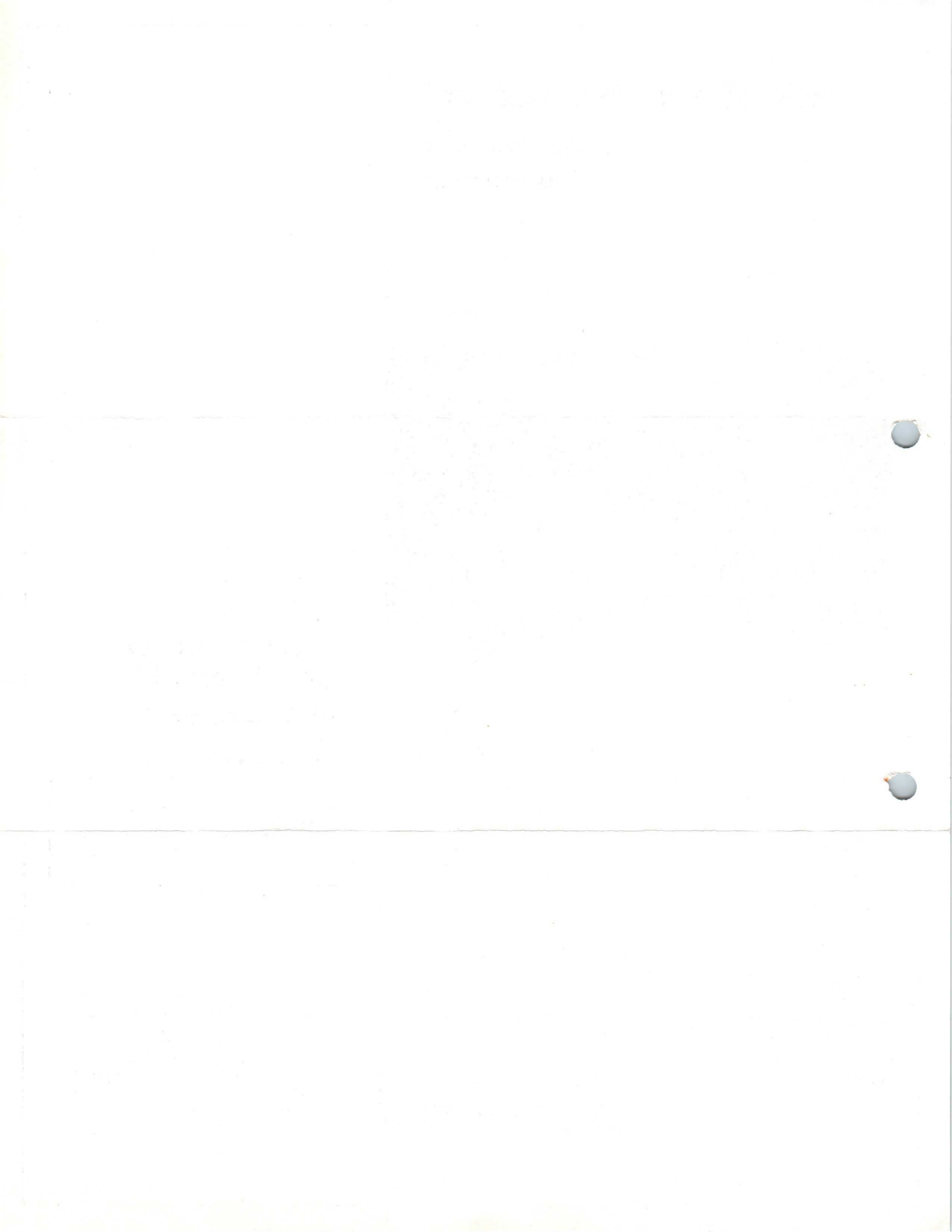



“The important message inside is intended for a vast audience of electronic engineers — however, it is equally important even if the audience is only half-vast.”

"Nat, Nat Metcom, where the devil were you?" the Boss roared. "If you can't take

your coffee break with the rest of the crew, pack your bag and get out of here." "Coffee, shmoffee, sure I just nipped across the street to Moran's for a snapper of Medford rum. Ah-h it sure puts the heart into a man even though

they've watered it down in the last hundred years."

"Now look here, Nat, I can't have you drinking on the job — you might set a bad example for all these expensive electronic engineers I'm paying — what would happen if they all went over to Moran's when a tough problem came up?" "All I can say, Boss, is that it's not such a bad idea. You might come up with the answer to the space race, if they all got high enough."

"Well, you better knock it off and start producing — By the way, what have you done all week?"

"What have I done, are you daft, man, sure I got you the front page story in the *KLYSTRACHAUN NEWS & FISHWRAPPER*, didn't you see it?"

"How can I see it, much less read it, when its only the size of a postage stamp. At any rate, what was the headline?"

"Here it is, 'METCOM'S COMPLETE LINE OF Ku REFLEX KLYSTRONS NORMALLY ASSOCIATED WITH LOCAL OSCILLATOR APPLICATIONS ALSO MAY BE USED AS PARAMETRIC AMPLIFIER PUMPS.'"

"Well, that's not bad for a starter, what else did it say?"

"That's it, Salty, the whole story except for a big ad on the front page — it says, MORAN'S FOR MEDFORD RUM — QUICKEST WAY TO GET IN ORBIT."



**NAT B.
METCOM**

*"Metcom's Informative
Klystrachaun"*

DESCRIPTION: Reflex Klystron, Tuner, Waveguide Output, Mechanically Tuned. $F = 16$ to 17kMc .

ABSOLUTE RATINGS:

Parameters:	Ef	Ers	Er	Irs	F	TE	Alt.
Units:	V	Vdc	Vdc	Adck	Mc	°C	ft.
Maximum:	$6.3 \pm 10\%$	350	0-500	45	—	150	— 73,500
Minimum:	—	—	0	—	—	—	—
Test Cond.:	6.3	300	110	— 16.5	—	—	—

Test	Conditions	Min.	Max.	Unit
Heater Current:	—	lf:500	600	mA
Heater Cathode Leakage:	Ehk= $\pm 45\text{Vdc}$;	lhk:—	100	μAdc
Total Reflector Current:	Er= -140 to -200Vdc ;	lr:—	10	μAdc
Reflector Leakage Current:	Er= -140 to -200Vdc ;	lrl:—	6	μAdc
Emission:	Ef=5.7; Er/max.Po;	$\Delta lk/lk:—$	10	%
Cathode Current:	Er/max.Po;	Irs:—	35	mAdc
Power Output:	F=16.0 to 17.0 kMc; Er/max. Po;	Po:20	—	mw
Reflector Voltage (2):	F=16.5kMc; Er/max.Po;	Er:—100	—200	Vdc
*Electronic Tuning Range:	Er/50% max. Po; F=16.5 $\pm 0.7\text{kMc}$;	F:50	—	mc
Modulation Sensitivity:	Er/max.Po;	:1.3	3.5	Mc/V
*Tuner Shaft Sensitivity (1):	—	:—	350	Mc/v
Life Test:	Group C	t:500	—	hrs.
Life Test End Point:	Power Output;	Po: 15	—	mw

A Pump with a History and a Future

Here is the DATA you requested
through Reader Service card from

electronics

P DURHAM
ENGLISH ELECTRIC VALVE CO LTD
CHELMSFORD
ESSEX

CH TECH PUBL
ENGLND



From a 17th Century Well Sweep Pump to a new parametric amplifier pump Klystron, conceived and in production at Metcom. The new Klystron features are: a dielectric tuner, a wider frequency range selection than any other Pump Klystron, a new locking device, and a tuner that can be physically changed to meet different needs and designs. The parametric Pump Klystron is now in production, samples and specifications are available. The Pump Klystron can be adapted or ordered to custom design. Unlike other Klystrons, the user is not limited to specific frequency selections.

DIELECTRICALLY TUNED KLYSTRONS

As you requested . . .

We are sending you more information concerning the Metcom Pump Klystron for Parametric Amplifiers featured in this ad.

The typical specifications for tubes presently in production and in use in field systems are tabulated on the back of this sheet. Should your requirements not be filled by the data on this sheet, the facilities of the Metcom Klystron engineering department are at your service for modification or redesign. We appreciate your inquiring and we hope to be of service to you in the near future.

for better microwave tubes and devices



METCOM INC.
SALEM, MASSACHUSETTS

THIS AD APPEARED IN THE MARCH ISSUES OF MICROWAVE JOURNAL,
SOLID STATE DESIGN, MICROWAVES AND ELECTRONICS.

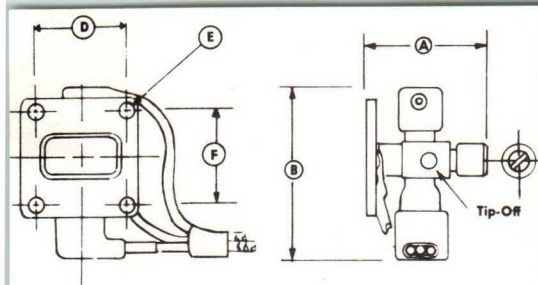

Flange mates with UG-39 or 40/U Flange.

REF	DIMENSIONS IN INCHES
A	2.000 Max
B	2.375 Max
D	1.220 ± .004
E	0.220 Dia.
F	1.280 ± .004
J	0.700 ± .015

FIGURE #1

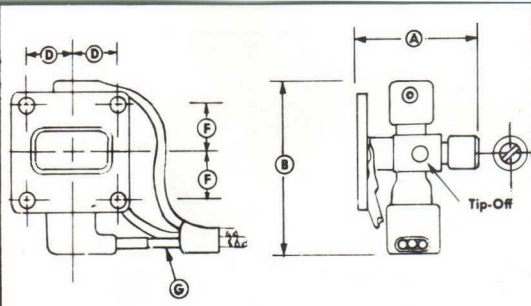

Flange mates with UG-419 or 541/U Flange.

REF	DIMENSIONS IN INCHES
A	1.750 Max.
B	2.375 Max.
D	0.495-0.499
F	0.478 ± .002
G	18.00
J	0.700 ± .015

FIGURE #2

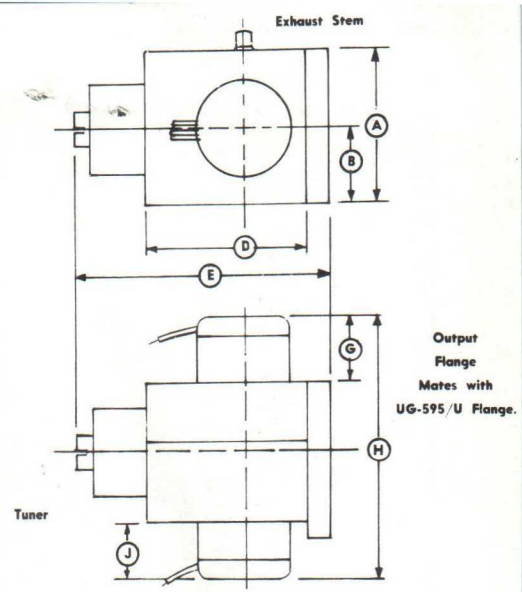

REF	DIMENSIONS IN INCHES
A	7/8
B	7/16
D	7/8
E	1 5/8 Max.
G	7/8
H	1 1/2 Approx.
J	5/16

TUBE NUMBER	Typical Power Output mw	Typical Tuning Range G. C.	Typical Beam Voltage Vdc	Typical Beam Current Idc	Typical Reflector Voltage -Vdc	Outline Drawing
MXK-30	500 mw	7.0-8.5	500 V	60 ma	-300	Figure 1
MXK-63	500	8.4-9.6	500	60	-300	Figure 1
MXK-67	500	8.5-10.0	500	60	-300	Figure 1
MXK-61	500	8.55-9.155	500	60	-300	Figure 1
MXK-60	500	9.6-10.2	500	60	-300	Figure 1
MXK-62	100	9.8-11.2	400	50	-300	Figure 1
MXK-68	500	10.0-11.5	500	60	-300	Figure 1
MXK-54	500	10.7-11.7	500	60	-300	Figure 1
MXK-55	500	11.7-12.7	500	60	-300	Figure 1
MXK-69	500	11.5-12.5	500	60	-300	Figure 1
MKK-30	100	12.4-15.0	400	40	-180	Figure 2
MKK-29	60	13.2-13.5	300	30	-100	Figure 2
MKK-31	100	16.0-18.0	450	40	-180	Figure 2
MKK-18	300	17.0-18.0	600	40	-300	Figure 2
MKK-32	100	22.5-25.0	400	40	-250	Figure 3
MKK-19	30	23.6-24.5	375	30	-180	Figure 3

- (1) All Klystrons have 6.3 Volt Heaters.
- (2) Any Klystron listed above can be delivered with 6.3 Volt 0.5 Ampere Heaters.
- (3) All Klystrons listed above have uniform power response over the specified Tuning Range.
- (4) All Klystrons listed above and shown on the figures above are supplied with 18" Flying Leads with 0.375" Tinned Ends.
- (5) Should the customer desire, any Klystron shown can be supplied with base and top cap connections in lieu of Flying Leads.



Please return to T.P.D.

MICROWAVE ELECTRONIC TUBE COMPANY, INC.
76 LAFAYETTE STREET • SALEM, MASSACHUSETTS



Metcom, strong in engineering talent, has combined over 160 years of engineering know-how with the best in manufacturing facilities. Your inquiries are earnestly solicited on any problems you may have in the field of microwave tubes and devices.

METCOM

MICROWAVE ELECTRONIC TUBE CO., INC.

GAS SWITCHING DUPLEXER TUBES

L BAND TUNABLE BANDPASS PRE TR TUBES

Tube Type	Type	Frequency In Mc	Peak Power In Kw	Average Power In Watts	Description
6633	BandPass TR	1220-1365	2000	2000	Broadband High Power TR
7166	BandPass TR	1215-1365	2000	4000	Short Length—Improved 6633
MLT-13	BandPass TR	1250-1350	50	50	Broadband Crystal Protector
7152	Pre- TR	1250-1350	2000	4000	Broadband High Power Pre- TR

L BAND ATR TUBES

MLA-10	ATR	1300	2000	4000	Hard Pumped Hard Brazed Fixed Tuned ATR
--------	-----	------	------	------	--

S BAND-TUNABLE-BANDPASS PRE-TR TUBES

Number Designation	Type	Frequency In Mc	Peak Power In Kw	Average Power In Watts	Brief Description
1B55A	Band Pass TR	3365-3740	740	600	Fixed Tuned TR
1B58A/ MST-12	Band Pass TR	2664-2964	750	600	Fixed Tuned TR
5853	Band Pass TR	2900-3200	750	600	Fixed Tuned TR
5927	Band Pass TR	3100-3500	750	750	Fixed Tuned TR
6117/ MST-11	Band Pass TR	2664-2964	750	600	10 Hole Flange 1B58A
MST-10	Band Pass TR	2700-2900	4	5	Low Power 1B58A
MST-15	Band Pass TR	2900-3200	4	4	3 Element Crystal Protector
6636	Dual Band Pass TR	2700-2900	750	750	Dual 1B58A
MST-16	Coaxial Tunable TR	2800-3000	100	100	Type N Coaxial Input and Output
MST-20	Coaxial Bandpass TR	2800-3000	750	750	Type N Coaxial Input and Output
MST-22	Dual Bandpass TR	2700-2900	1000	1000	Dual Three Element TR

S BAND ATR TUBES

Number Designation	Type	Center Frequency In Mc	Peak Power In Kw	Average Power In Watts	Brief Description
1B44	ATR	2750	750	750	Hard Pumped Hard Brazed Fixed Tuned ATR
1B53	ATR	3479	750	600	Hard Pumped Hard Brazed Fixed Tuned ATR
1B56	ATR	2850	750	750	Hard Pumped Hard Brazed Fixed Tuned ATR
5792	ATR	2950	750	750	Hard Pumped Hard Brazed Fixed Tuned ATR
5793	ATR	3050	750	750	Hard Pumped Hard Brazed Fixed Tuned ATR
5921	ATR	3200	750	750	Hard Pumped Hard Brazed Fixed Tuned ATR
5922	ATR	3400	750	750	Hard Pumped Hard Brazed Fixed Tuned ATR
6024	ATR	2800	750	600	Hard Pumped Hard Brazed Fixed Tuned ATR
MSA-10	ATR	2800	1000	1200	Fast RT ATR
MSA-13	ATR	2950	2000	2000	Hard Pumped Hard Brazed Fixed Tuned ATR
MSA-14	ATR	3050	2000	2000	Hard Pumped Hard Brazed Fixed Tuned ATR

C BAND-TUNABLE BANDPASS PRE- TR TUBES

Number Designation	Type	Frequency In Mc	Peak Power In Kw	Average Power In Watts	Brief Description
6905/MCT-10	Dual Band Pass TR	5395-5905	3000	4500	Dual TR
6906	Band Pass	5395-5905	5	7.5	TR with Phase Control
6624/MCT-13	Band Pass TR	5350-5450	85	85	3 Element TR
6639	Tunable TR	5450-5650	15	15	Tunable TR

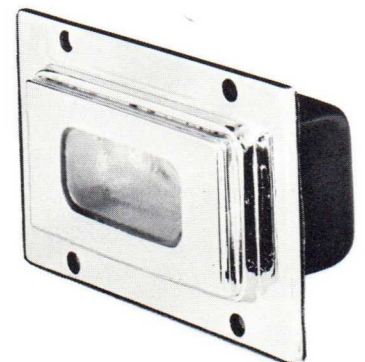
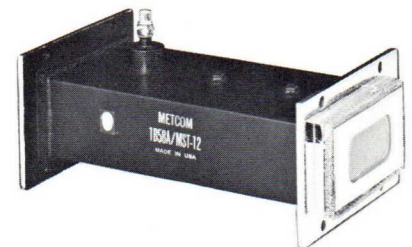
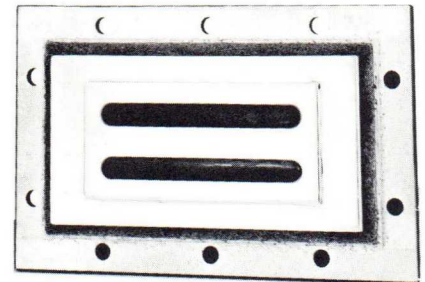

C BAND-TUNABLE BANDPASS PRE- TR TUBES (Continued)

No. Designation	Type	Frequency In Mc	Peak Power In Kw	Average Power In Watts	Description
6640/MCT-16	Dual Band Pass TR	5400-5900	700	700	Fixed Tuned Dual TR
6568/MCT-17	Band Pass TR	5395-5905	3000	4500	Fixed Tuned TR
5865	Band Pass TR	5395-5905	300	300	Fixed Tuned TR
5925	Band Pass TR	5200-5530	1000	1000	Fixed Tuned TR
MCT-11	Band Pass TR	5395-5905	3000	4500	6568-Choke Flange, Low Power Side
MCT-15	Tunable TR	5540-5560	1	125	Fast R.T. — 6639
MCT-18	Pre TR	5395-5905	3000	4500	Fixed Tuned Pre TR
MCT-12	Dual Band Pass, Pre TR	5400-5900	10	10	Dual Pre TR
MCT-20	Dual Band Pass TR	5250-5310	1000	1000	Fixed Tuned Dual TR
MCT-21	Band Pass TR	5395-5905	500	500	High Power 5865
MCT-19	BandPass TR	5400-5900	.4	.004	Saddle Mount
MCT-20	BandPass TR Dual	5250-5310	1000	1000	Dual TR with Ceramic Windows
MCT-22	BandPass TR	5395-5905	2000	3000	Single Ceramic Window Special Flange
MCT-24	BandPass TR	5250-5350	300	300	BandPass Type
MCT-27	BandPass TR	5395-5905	500	500	Crystal Protector
MCT-28	Coaxial BandPass TR	5395-5905	10	10	Type N Input and Output



C BAND ATR TUBES

Number Designation	Type	Center Frequency In Mc	Peak Power In Kw	Average Power In Watts	Brief Description
6591/MCA-10	ATR	5400	150	150	Hard Pumped Hard Brazed Fixed Tuned ATR
6022	ATR	5365	1000	1000	Hard Pumped Hard Brazed Fixed Tuned ATR
6081	ATR	5640	300	300	Hard Pumped Hard Brazed Fixed Tuned ATR
6455/MCA-12	ATR	5640	300	300	Hard Pumped Hard Brazed Fixed Tuned ATR

X BAND-TUNABLE BANDPASS PRE- TR TUBES

Number Designation	Type	Frequency In Mc	Peak Power In Kw	Average Power In Watts	Brief Description
1B24A/MXT-14	Tunable TR	8490-9600	100	100	Integral Cavity Tunable
1B63A/MXT-15	Band Pass TR	8490-9578	200	200	Band Pass Fixed Tuned
1B63B	Band Pass TR	8490-9578	200	200	1000 Hour Life 1B63A
6378/MXT-20	Tunable TR	8490-9600	100	100	1B24A Without Reservoir
6334/MXT-19	Dual Band Pass TR	8490-9578	200	200	Dual 1B63A Small X-Band Flanges
7381	Dual Band Pass TR	8490-9610	150	150	6334 Outline for High & Low Temperature Environment
6642	Dual Band Pass TR	8490-9578	200	200	6334 with Large X-Flange Input and small X-Flange Output
6645	Band Pass TR	8490-9578	100	100	1B63A with Heaters for Low Temperature Operation
6645-A	Band Pass TR	8490-9578	100	100	1B63A for use in High and Low Temperature Environment without heaters
6795-A/MXT-13	Band Pass TR	9000-9400	40	40	Narrow Band Crystal Protector
MXT-10	Band Pass TR	9100-9500	10	10	Narrow Band Crystal Protector
MXT-12	Dual Band Pass TR	8490-9578	200	200	.100 Common Wall 6334
MXT-17	Band Pass TR	8490-9578	200	200	High Rep Rate Fast RT TR
MXT-21	Band Pass TR	9240-9450	5	5	4-Element Crystal Protector for High and Low Temperature Environment
MXT-22	Dual TR	8490-9578	100	100	Dual TR with Phase Control
MXT-23	Single TR	8490-9578	100	100	Single TR with Phase Control
MXT-24	Dual TR	8600-9600	500	500	Large X In Small X Out Dual TR Special Input Flange
MXT-27	Dual TR	8490-9578	250	250	Dual TR for High and Low Temperature Operation without heaters
MXT-29	Tunable TR	9300-10000	100	100	Modified 6378 for use on high and low Temperature environment
MXT-31	Dual Band Pass TR	8490-9578	500	500	Large X In Small X Out Dual TR Standard Flanges
MXT-32	Dual Pre TR	8500-9600	200	200	Dual Pre TR 30 db Signal Reduction
MXT-33	Band Pass TR	8500-9600	10	10	Short Length Broadband Crystal Protector
MXT-34	Dual Band Pass TR	8490-9578	10	10	3 Element Dual Crystal Protector
MXT-26	BandPass TR Dual	8490-9578	500	500	Impedance Input Flange
MXT-37	BandPass TR	8700-8900	.125	25	50 Kc Rep Rate
MXT-38	BandPass TR	8700-8900	.05	5	50 Kc Rep Rate
MXT-39	BandPass TR	8490-9610	200	200	1B63A To Operate at +125°C and Severe Environmental Conditions
MXT-40	BandPass TR Dual	8490-9578	500	500	Impedance Flange
6232	BandPass TR	8490-9578	200	200	Special Flange 1B63A



X BAND-TUNABLE BANDPASS PRE- TR TUBES (Continued)

Number Designation	Type	Center Frequency In Mc	Peak Power In Kw	Average Power In Watts	Brief Description
MXT-46	BandPass TR	8490-9578	10	10	Foreshortened Crystal Protector Min. Breakdown 75 mw.
MXT-47	BandPass TR Dual	8490-9578	200	200	6334 with 100 mw. Min. Breakdown
MXT-48	BandPass TR Dual	8490-9578	300	300	Dual TR with phase match $\pm 3^\circ$
MXT-49	BandPass TR	8490-9578	300	300	Single BandPass TR Phase Match $\pm 3^\circ$
MXT-51	Cross Guide Duplexer	9325-9425	100	100	Cross Guide Duplexer
MXT-52	BandPass TR	8490-9578	10	10	Crystal Protector
MXT-53	BandPass TR Dual	8490-9578	200	200	Min. Breakdown 200 mw Impedance Flange Input — Struts for Vibration Support -Foreshortened
MXT-54	BandPass TR Dual	8400-9578	500	500	Impedance Flange Input Special
MXT-56	BandPass TR	8490-9578	10	10	Low Insertion Loss Low Minimum Breakdown Power—Foreshortened TR
MXT-58	BandPass TR	8490-9578	200	200	1B63A Tapped Holes Input and Output Flange
MXT-59	BandPass TR	8490-9578	10	10	Foreshortened TR — 25° $\pm 100^\circ\text{C}$ 7381 Vibration Values



X BAND ATR TUBES

Number Designation	Type	Center Frequency In Mc	Peak Power In Kw	Average Power In Watts	Brief Description
1B35A	ATR	9300	250	250	Hard Brazed Hard Pumped Fixed Tuned ART
1B37A	ATR	8750	250	250	Hard Brazed Hard Pumped Fixed Tuned ART
5864	ATR	9375	250	250	Hard Brazed Hard Pumped Fixed Tuned ATR for RG51/U Guide
5883	ATR	8800	250	250	Hard Brazed Hard Pumped Fixed Tuned ATR
6163/MXA-11	ATR	9050	250	250	Hard Brazed Hard Pumped Fixed Tuned ATR
6393	ATR	9300	250	250	Hard Brazed Hard Pumped Fixed Tuned ATR
6396	ATR	9300	250	250	Hard Brazed Hard Pumped 6393 in half height guide
MXA-10	ATR	9300	30	30	Hard Brazed Hard Pumped ATR for Low Power High Temperature Operation
MXA-12	ATR	9300	250	250	Hard Brazed Hard Pumped ATR for High and Low Temperature Environment
MXA-13	ATR	9650	30	30	Hard Brazed Hard Pumped Fixed Tuned ATR for High & Low Environment

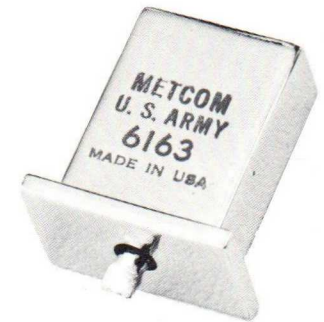

K BAND-TUNABLE BANDPASS PRE- TR TUBES

Number Designation	Type	Frequency In Mc	Peak Power In Kw	Average Power In Watts	Brief Description
6282/MKT-11	Band Pass TR	23350-24950	50	25	3 Element Band Pass TR

METCOM NEW LINE OF CiTRIMS* RECEIVER PROTECTORS

No. Designation	Frequency In Mc	Peak Power In Kw	Average Power In Watts	Solenoid Voltage VDC	Attenuation with CiTRims Closed
MXT-28	9600-10,000	1	1	28	40db Min.
MXT-30	8490-9578	250	250	28	40db
MXT-35	8375-9375	250	250	21	40db
MXT-36	9600-10,000	1	1	28	40db
MXT-43	8490-9578	250	250	28	40db
MXT-44	8490-9578	250	250	28	40db
MXT-50	8500-9600	500	500	28	40db
MXT-57	8490-9578	250	250	28	40db
MCT-25	5400-5900	700	700	28	40db



*Copyright applied for

DUPLEXERS

METCOM has available an extensive line of waveguide and coaxial duplexers. We solicit your inquiries concerning Duplexer Problems in any frequency range, power level, or configuration.

COAXIAL FERRITE ISOLATORS

METCOM manufactures a complete line of BroadBand Coaxial Ferrite Isolators with Type N or TNC Connectors in S, C, and X-Band.

Detailed Specifications available upon request.

CRYSTAL MIXERS

METCOM has available an extensive line of wave guide Crystal Mixers—included in the line are low cost high performance units for commercial application, as well as complete MIL low noise crystal mixers.

KLYSTRONS

X BAND REFLEX

Number Designation	Frequency k MC	Minimum Power Output mW		Resonator Voltage V	Reflector Voltage Min. Max.		Brief Description
6310 MXK-14	8.5-10.0	15	200	-75	-165	Single Screw Tuner — Waveguide coupling—3 pin Pee wee base and reflector cap.	
		40	300	-90	-250		
6312/MXK-15	8.5-10.0	15	200	-75	-165	Single Screw Tuner Wageguide coupling 18" leads	
		40	300	-90	-250		
6314/MXK-16	8.5-10.0	15	200	-75	-165	Lock nut tuning Waveguide output 18" leads	
		40	300	-90	-250		
6315/MXK-17	8.5-10.0	30	250	-50	-120	Single Screw Tuner Waveguide Coupling 18" Leads	
6316/MXK-18	8.5-10.0	15	200	-75	-165	Lock Nut Tuning Waveguide Output Viking Connector	
		35	300	-90	-250		
6781/MXK-11 X	8.5-10.0	15	200	-75	-165	Single Screw Tuner Waveguide Output Viking Connector	
		40	300	-90	-200		
6975/MXK-10 X	8.5- 9.6	20	300	-55	-135	Heater Current 0.4—0.5 A External Cavity Tuning Waveguide Output 3 pin Pee Wee Base and Reflector Cap	
		30	300	-90	-250		
MXK-12 X	8.5-10.0	15	200	-75	-165	Single Screw Tuner Waveguide Output Viking Connector	
		40	300	-90	-200		
MXK-19	8.5-10.0	15	210	-75	-165	Single Screw Tuner on Cathode side of tube, completely insulated tube body and tuner—Deutch connector	
		35	300	-90	-200		
MXK-20	11000	15	200	-75	-165	6781 Centered at 11000 KMc	
		40	300	-90	-200		

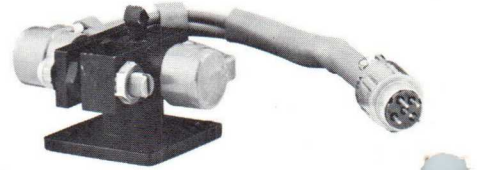

SPARK GAPS

Number Designation	Breakdown Voltage		Peak Power Kw	Average Power W	Peak Current A
	Min.	KV. Max.			
MDS-10 X	16.0	18.0	45	25	450
MDS-12 X	18.0	20.0	55	175	110
MDS-13 X	8.5	10.0	14	45	28
MDS-14 X	10.5	12.0	195	585	390
MDS-15 X	23.0	27.0	2200	2200	3700
MDS-16 X	5.5	6.5	500	500	30
MDS-17 X	14.0	16.0	1300	1600	2100
MDS-18 X	16.0	18.0	1100	1400	1820
MDS-19 X	6.5	7.5	500	500	30

MXK-21/6975 X
MXK-22 X

MAGNETRONS

Number Designation	Frequency Mc	Peak Output Watts	Peak Anode Voltage KV		Peak Anode Current A	Pulse Duration us	Duty Cycle	Brief Description
MCM-10 X	5500-5600	10000	7.5	4.0	.200	.0003	Fixed-tuned Pulsed	
MCM-11 X	5400-5900	100	1.3	.8	1.0	.002	Tunable Pulsed Beacon Application	
MCM-12 X	5400-5900	400	2.0	1.1	1.0	.002	Tunable Pulsed Beacon Application	
MCM-13 X	5400-5900	1000	2.8	1.9	1.0	.002	Tunable Pulsed Beacon Application	
MCM-14 X	5400-5900	400	2.2	1.2	1.0	.002	Tunable Pulsed Beacon Application	

MCM-15, 16, 17, 18, 19, 20, 21 X

C-BAND

Number Designation	Frequency Mc	Peak Output Watts	Peak Anode Voltage KV		Peak Anode Current A	Pulse Duration us	Duty Cycle	Brief Description
MXM-10 X	9375 ± 30	800	2.8	1.5	.250	.0004	Fixed-tuned-Pulsed	
MXM-11 X	9000-9500	100		.8	1.0	.002	Tunable-Pulsed Beacon Application	
MXM-12 X	9375 ± 30	3500	3.7	4.33	.250	.0004	Fixed-tuned-Pulsed	
MXM-13 X	8500-8900	100	1.325	.9	1.0	.002	Tunable-Pulsed Beacon Application	
MXM-14 X	8900-9600	100	1.225	.9	1.0	.002	Tunable-Pulsed Beacon Application	

MXM-15 X
MXM-16 X



WAVEGUIDE COMPONENTS

Number Designation	Band	Frequency MC	Description
MXP-10	X	9375 ± 30	Duplexer Tee
MXP-11	X	9375 ± 30	Crystal Mixer
MXP-12	X	9375 ± 30	Double Bend Section
MXP-13	X	9375 ± 30	Flexible Wave Guide Section

PRESSURIZING WINDOWS

S BAND

Number Designation	Frequency Coverage	Max. VSWR	Peak Power (Kw)	Pressure Differential (psig)	W/G Size
MSW-1	2675-2925	1.10	750	30	RG-48/U Solderable
MSW-3	2800-3200	1.20	750	30	Flange Mounted
MSW-5	2700-2900	1.20	750	30	Flange Mounted
MSW-6	2675-2925	1.10	1000	30	RG-48/U Solderable
MSW-7	2800-3200	1.20	750	30	Solderable
MSW-10	2600-3700	1.30	750	30	Triple slot solderable
MSW-2	2670-2620	1.1	750	30	RG-48/U Solderable Viewing Window
MSW-4	2600-3700	1.2	1000	30	RG-48/U Flange Mounted
MSW-8	2600-4000	1.5	1000	30	RG-48/U Flange Mounted
MSW-10	2600-3700	1.3	—	30	RG-48/U Triple Slot Solderable

C BAND

Number Designation	Frequency Coverage	Max. VSWR	Peak Power (Kw)	Pressure Differential (psig)	W/G Size
MCW-1	5200-5900	1.20	500	30	RG-50/U Solderable
MCW-2	5100-5320	1.15	500	30	RG-49/U Solderable
MCW-3	4900-5100	1.15	500	30	RG-49/U Solderable
MCW-4	5250-5850	1.10	800	45	Triple slot solderable
MCW-5	5800-8200	1.10	500	30	Triple slot solderable
MCW-7	5100-5900	1.25	500	30	RG-49/U Solderable
MCW-8	5450-5825	1.12	750	30	RG-49/U Solderable
MCW-8	5450-5825	1.12	750	30	RG-49/U Solderable
MCW-10	4900-5100	1.15	100	30	RG-49/U Solderable

X BAND

Number Designation	Frequency Coverage	Max. VSWR	Peak Power (Kw)	Pressure Differential (psig)	W/G Size
MXW-1	9150-9600	1.10	430	30	Flange Mounted
MXW-2	8600-10000	1.10	430	30	Flange Mounted
MXW-3	9210-9410	1.10	250	30	RG-51/U Solderable
MXW-4	8830-9330	1.10	430	30	Flange Mounted
MXW-5	9200-9420	1.10	250	30	RG-52/U Solderable
MXW-6	8830-9330	1.10	430	30	Flange Mounted
MXW-7	8700-8900	1.10	430	30	Flange Mounted
MXW-8	8645-9555	1.15	430	30	Flange Mounted
MXW-9	6150-6850	1.3	250	30	RG-50/U Solderable
MXW-10	9200-9420	1.10	250	30	RG-52/U Solderable
MXW-11	8530-8750	1.10	250	30	RG-52/U Solderable
MXW-12	8650-8870	1.10	250	30	RG-52/U Solderable
MXW-13	8870-9090	1.10	250	30	RG-52/U Solderable
MXW-14	8990-9210	1.10	250	30	RG-52/U Solderable
MXW-15	9250-9405	1.10	430	50	Flange Mounted
MXW-16	8500-9600	1.12	500	30	Mica Flange Mounted
MXW-17	9400-9600	1.20	250	30	RG-52/U Solderable
MXW-18	8490-9600	1.15	430	30	Flange Mounted
MXW-19	9150-9600	1.10	430	30	Flange Mounted
MXW-22	8500-9600	1.12	500	30	Flange Mounted
MXW-24	10200-10300	1.3	500	30	RG-52/U Solderable
MXW-25	8490-9578	1.12	500	30	RG-51/U Solderable
MXW-28	8490-9578	1.12	500	30	RG-52/U Mica Flange Mounted
MXW-29	9000	1.2	500	30	RG-52/U Solderable
MXW-35	9900	1.10	150	30	RG-52/U Solderable
MXW-40	8400-9600	1.08	200	30	Triple slot Solderable
MXW-42	8490-9578	1.15	200	30	Flange Mounted
MXW-43	8500-10240	1.2	200	30	RG-52/U Solderable
MXW-44	8500-9600	1.2	300	30	Triple slot Solderable
MXW-49	9100	1.15	300	30	Flange Mounted
MXW-21	8100-12400	1.20	—	30	RG-52/U Mica Solderable
MXW-23	9200-9420	1.10	250	30	MXW-10 .060 Kovar
MXW-26	9200-9420	1.10	250	30	MXW-10 .040 Kovar
MXW-27	9300 ± 20	1.10	250	30	RG-52/U Solderable

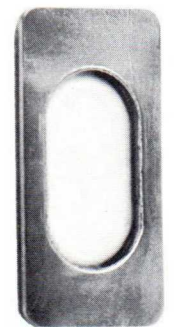
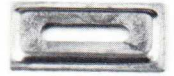

Sales Representatives

NEW ENGLAND STATES

George Gregory Associates
99 Elm Street
West Newton, Massachusetts
Tel.: Bigelow 4-4832

UPPER NEW YORK STATE

E W Stone Company
308 Merrit Avenue
Syracuse, New York
Tel.: Howard 9-3825

SOUTHERN N. Y., N. Y. CITY AND NORTHERN N. J.

CDB Enterprises
501 Broadway
Hicksville, N.Y.
Tel.: Wells 8-8644

EASTERN PA., SOUTHERN N. J., MARYLAND, COLORADO, UTAH, WYOMING, SOUTHERN DELAWARE AND TENNESSEE

J. H. Electronic Sales Company
P. O. Box 6844
Towson, Maryland
Tel.: Valley 5-4441

Newtown, Pa.
Tel.: Worth 8-3076

WASHINGTON, D. C.

Mr. Robert Mathias
1507 M Street
Washington, D.C.
Tel.: Columbia 5-3080

VIRGINIA AND NORTH CAROLINA

Mr. Ted Britt
1507 M Street
Washington, D. C.
Tel.: Columbia 5-3080

FLORIDA AND HUNTSVILLE, ALABAMA

Chris Small Company
1703 Conway Road
Orlando, Florida
Tel.: Garden 2-7342

DAYTON, OHIO

Paul J. Bockenstedt & Associates
P. O. Box 175
Dayton 24, Ohio
Tel.: Beverly 3-0849

ILLINOIS, INDIANA, WISCONSIN AND OHIO

H. G. Pretat, Inc.
4 North Cicero Avenue
Chicago, Illinois
Tel.: Columbus 1-3146

NORTH DAKOTA, SOUTH DAKOTA AND MINNESOTA

Scott Electronic Sales
6500 Xerxes Avenue
So. Minneapolis 23, Minnesota
Tel.: Walnut 6-3919

MISSOURI, KANSAS, NEBRASKA

W. E. Fry Co.
Broadway & 34th Street
Kansas City, Missouri
Tel.: Jefferson 5236

IDAHO AND EL PASO COUNTY, TEXAS

Kelley Enterprises
336 E. 4th Street
Loveland, Colorado
Tel.: NOrmandy 7-1376

CALIFORNIA & SEATTLE, WASHINGTON

C. W. Swift & Associates
15166 Ventura Blvd.
Sherman Oaks, California
Tel.: TRiangle 3-2046

CANADIAN SALES

The Ahearn & Soper Co., Ltd.
384 Bank Street
Ottawa 4, Canada
Tel.: CE 6-9441

EXPORT SALES

Dage Corporation
219 East 44th Street
New York 17, New York
Tel.: Murray Hill 2-6755

ARIZONA and NEW MEXICO

Fryco Co.
Lighthall Bldg.
Scottsdale, Arizona
Tel.: WHitney 5-3281
5-8071

MICROWAVE ELECTRONIC TUBE COMPANY, INC.
76 LAFAYETTE STREET • SALEM, MASSACHUSETTS