

MILLIMETER-WAVE HIGH POWER TWTs

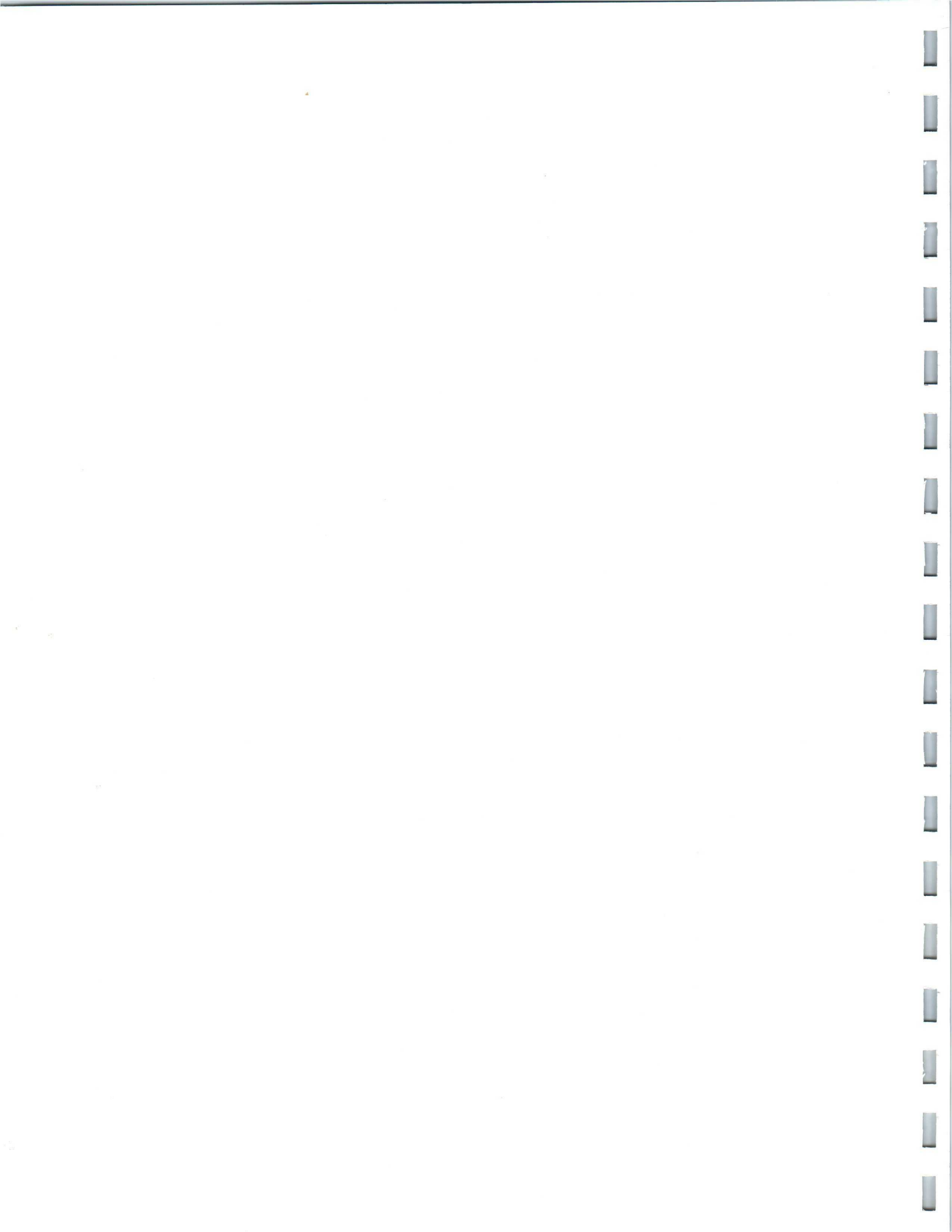



**MILLIMETER WAVE
HIGH POWER TWTs**

JUNE 1989

**HUGHES AIRCRAFT COMPANY
ELECTRON DYNAMICS DIVISION
3100 WEST LOMITA BOULEVARD
P.O. BOX 2999
TORRANCE, CA 90509-2999**

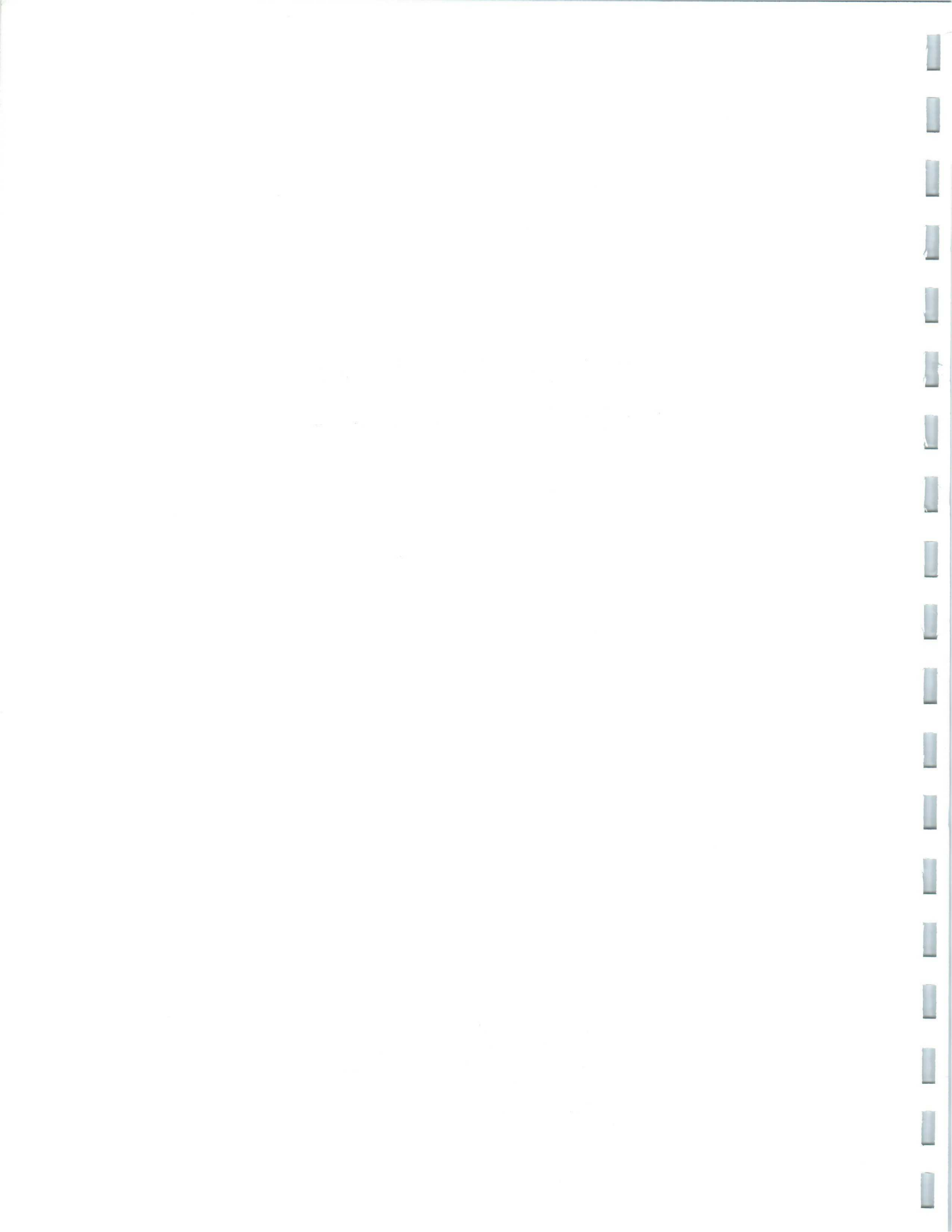
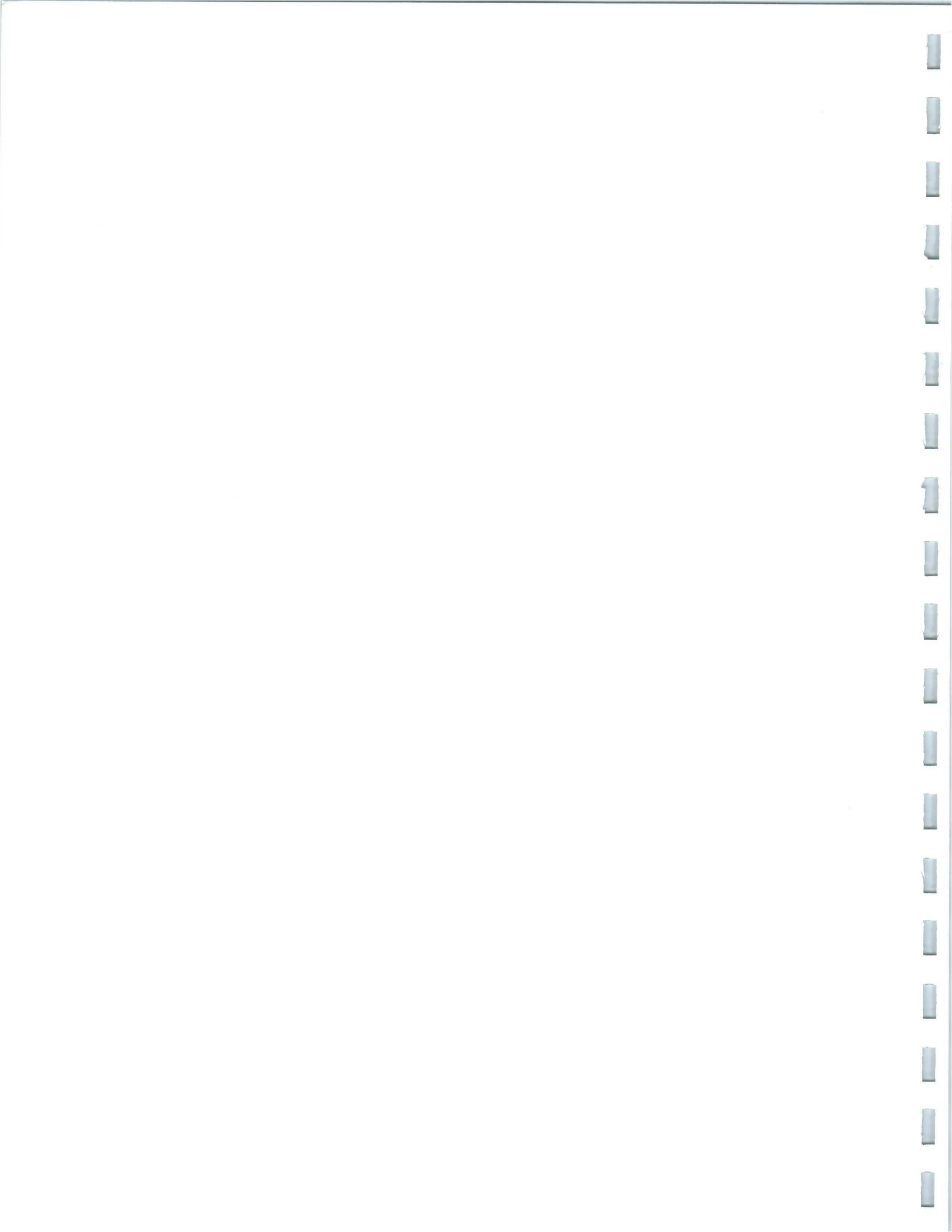

TABLE OF CONTENTS

<u>Section</u>		<u>Page No.</u>
1.0	INTRODUCTION	1-1
2.0	Ka-BAND TWTs	2-1
	914H, 200 W, CW, 30 GHz	
	951H, 400 W, CW, 30 GHz	
	933H, 1.0 kW, CW, 30 GHz	
	913H, 100 W, CW, 37 GHz	
	8910H, 4.0 kW, Pulsed, 35 GHz	
3.0	Q-BAND TWTs	3-1
	944H, 100 W, CW, 42 GHz	
	946H, 100 W, CW, 45 GHz	
	947H, 150 W, CW, 45 GHz	
	915H, 250 W, CW, 45 GHz	
	915HF, 250 W, CW, 45 GHz	
4.0	V-BAND TWTs	4-1
	960H, 5 W, CW, 60 GHz	
	961H, 75 W, CW, 65 GHz	
5.0	W-BAND TWTs	5-1
	982H, 80 W, Pulsed, 94 GHz	
	980H, 1.0 kW, Pulsed, 94 GHz	



1.0 INTRODUCTION

Hughes Aircraft Company has been at the forefront of the design and development of millimeter-wave traveling-wave tubes (TWTs) over the last twenty (20) years. Indeed, since the original millimeter-wave TWTs were produced in the early sixties, Hughes has been the primary supplier of these devices worldwide.

A listing of Hughes designed and manufactured millimeter-wave TWTs is given in Table 1-1. Also included is a curve, Figure 1-1, showing projected power output capabilities of our coupled-cavity millimeter-wave TWTs. Note that for purposes of carry-over from other Hughes TWT catalogs, we have defined the term millimeter-wave to include TWT products from 26 GHz up to 100 GHz.

Applications of our high frequency TWTs encompass systems for radar, communications, ECM, plasma physics, energy, space, and millimeter-wave instrumentation.

As a demonstration of capability at very high power levels at millimeter frequencies, coupled-cavity TWTs have been produced at power outputs of 5 kW CW at 55 GHz (reference the Model 819H TWT from the enclosed TWT list for coupled-cavity devices). These TWTs were produced as far back as the mid-Sixties for plasma physics research.

For communications applications, several coupled-cavity TWTs have been developed; e.g., the Model 951H TWT producing 400 watts of CW power output and the Model 933H TWT producing 1.0 kW of CW power output. Higher in frequency at 45 GHz is a series of TWTs that deliver 100 to 300 watts of CW power output. Although designed for the communications community, these tubes can be modified in frequency or power or gain for CW or pulsed power applications for practically any space, airborne, or terrestrial requirement.

Pulsed, gridded, high power TWTs are generally considered for radar or certain ECM programs—Hughes Electron Dynamics Division (EDD) has developed several devices including the 8910H TWT at 35 GHz and the 982H TWT at 94 GHz.

Because of the very small dimensional tolerances at high frequencies, piece part costs have been very high, until now. To address this problem, Hughes EDD has established new manufacturing methods to reduce circuit piece part costs. Ultra-precision CNC diamond turning technology has been recently adapted to the production of the cylindrical coupled-cavity circuit. Hughes has established a special-purpose diamond turning machine and facility, which is producing very highly repeatable circuits over the 30 to 100 GHz frequency range. Precision fine blanking techniques have also been established and are currently producing ferruleless circuits for applications at 30 and 45 GHz. In a continuing effort to further reduce the complexity and

TABLE 1-1
HUGHES EDD MILLIMETER-WAVE TWTS

Model/Type	Frequency	Power Level	CW/Pulsed	Focusing
914H	30 GHz	200 W	CW	PPM
951H	30 GHz	400 W	CW	PPM
933H	30 GHz	1 kW	CW	Solenoid
8910H	35 GHz	4 kW	0.05	PPM
913H	37 GHz	100 W	CW	PPM
915H	45 GHz	250 W	CW	PPM
915HF	45 GHz	250 W	CW	PPM
941H	45 GHz	200 W	CW	PPM
946H	45 GHz	100 W	CW	PPM
947H	45 GHz	150 W	CW	PPM
948H*	45 GHz	1 kW	CW	Solenoid
813H	55 GHz	1 kW	CW	Solenoid
819H	55 GHz	5 kW	CW	Solenoid
960H	60 GHz	5 W	CW	PPM
962H*	60 GHz	30 W	CW	PPM
961H	65 GHz	75 W	CW	PPM
964H*	60 GHz	200 W	CW	PPM
980H	94 GHz	1 kW	0.10	Solenoid
981H	94 GHz	200 W	0.20	Solenoid
982H	94 GHz	80 W	0.50	PPM
984H*	94 GHz	20 W	CW	PPM
987H*	94 GHz	100 W	CW	PPM

*Early stage of development.

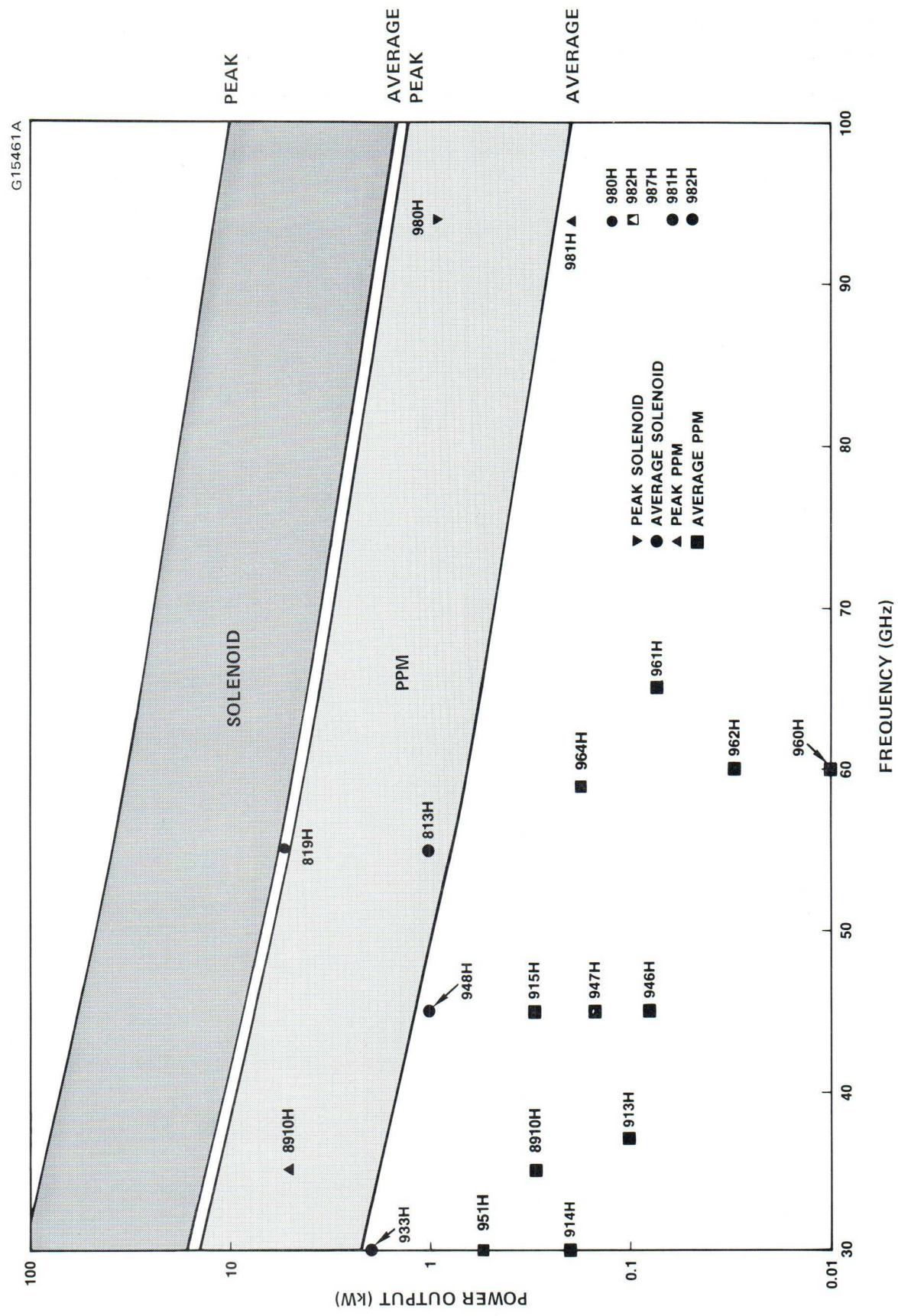

Figure 1-1 Projected average and peak power limits for PPM and solenoid focused millimeter-wave TWTs.

manufacturing costs of millimeter-wave circuits, Hughes is currently investigating and developing integral folded waveguide circuits which are produced using precision wire EDM techniques. With this technique, each circuit section is manufactured as a single piece.

Included in the following paragraphs are comments and specifications on our high power millimeter-wave TWTs.

2.0 Ka-BAND TWTs

914H Ka-Band TWT

The 914H is a communication, coupled-cavity traveling-wave tube producing 200 watts of CW power output over the 30.0 to 31.0 GHz frequency band. The electron gun utilizes a mod anode, and the beam is PPM focused. The 914H is direct air cooled and operates with a single-stage depressed collector.

The operating characteristics of the 914H are listed in Table 2-1. 914H RF performance is shown in Figure 2-1. A photograph of the packaged 914H TWT is shown in Figure 2-2. An installation control drawing is shown in Figure 2-3.

TABLE 2-1
OPERATING CHARACTERISTICS OF THE 914H

<u>RF Characteristics</u>	
Frequency	30.0 to 31.0 GHz
Power Output	200 watts
Gain	35 dB
Duty	CW
<u>Electrical Characteristics</u>	
Cathode Voltage	-16.0 kV
Cathode Current	0.078 A
Collector Voltage	-10 kV
Collector Current	0.071 A
Body Current	0.007 A
Heater Voltage	6.0 V
Heater Current	1.0 A

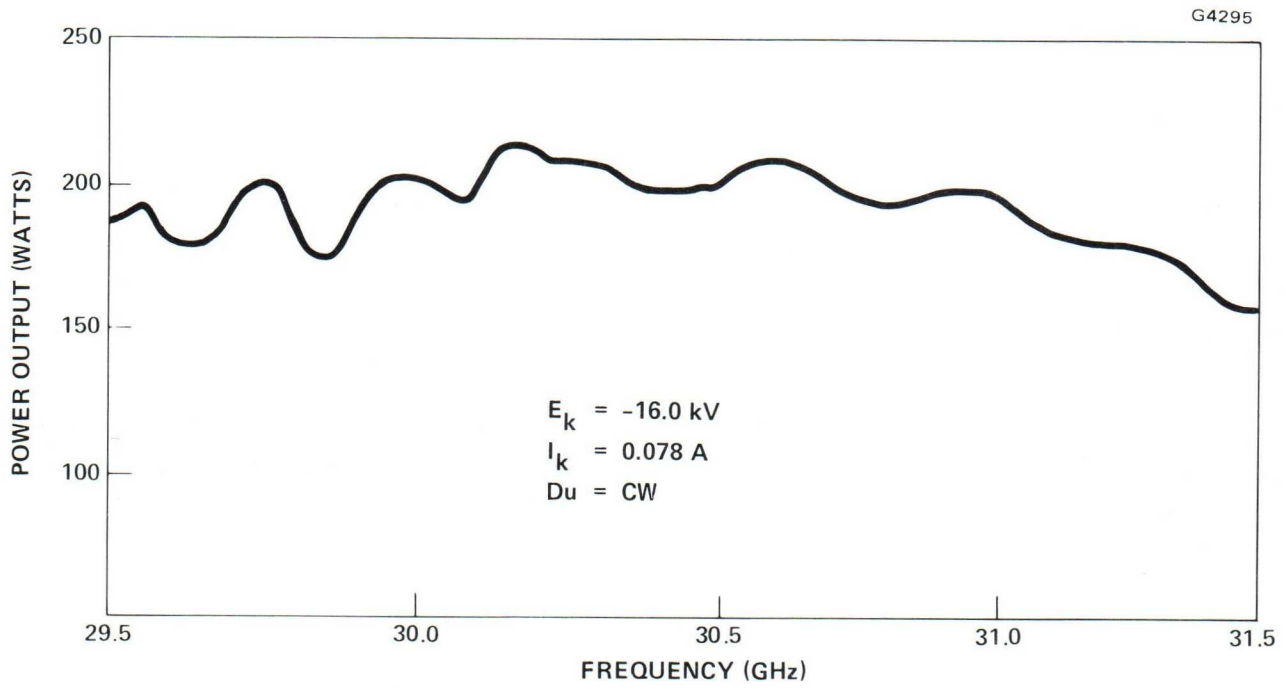

Figure 2-1 Power output vs frequency for the 914H TWT.

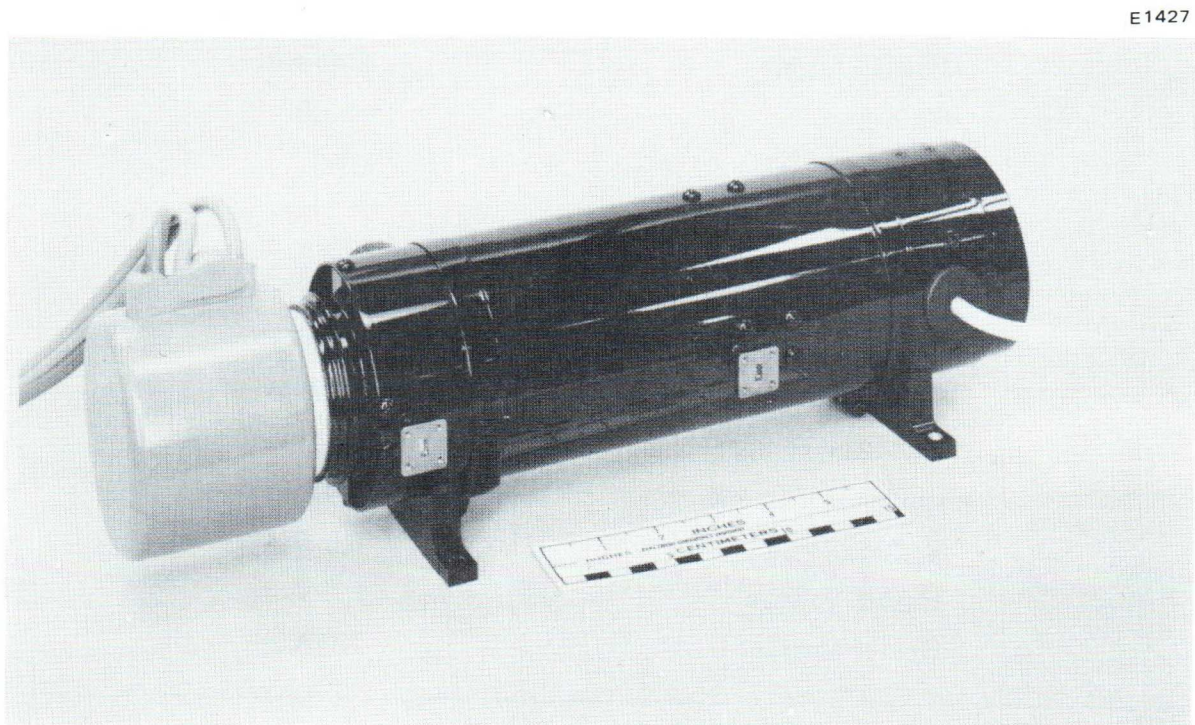

Figure 2-2 Photograph of 914H TWT.

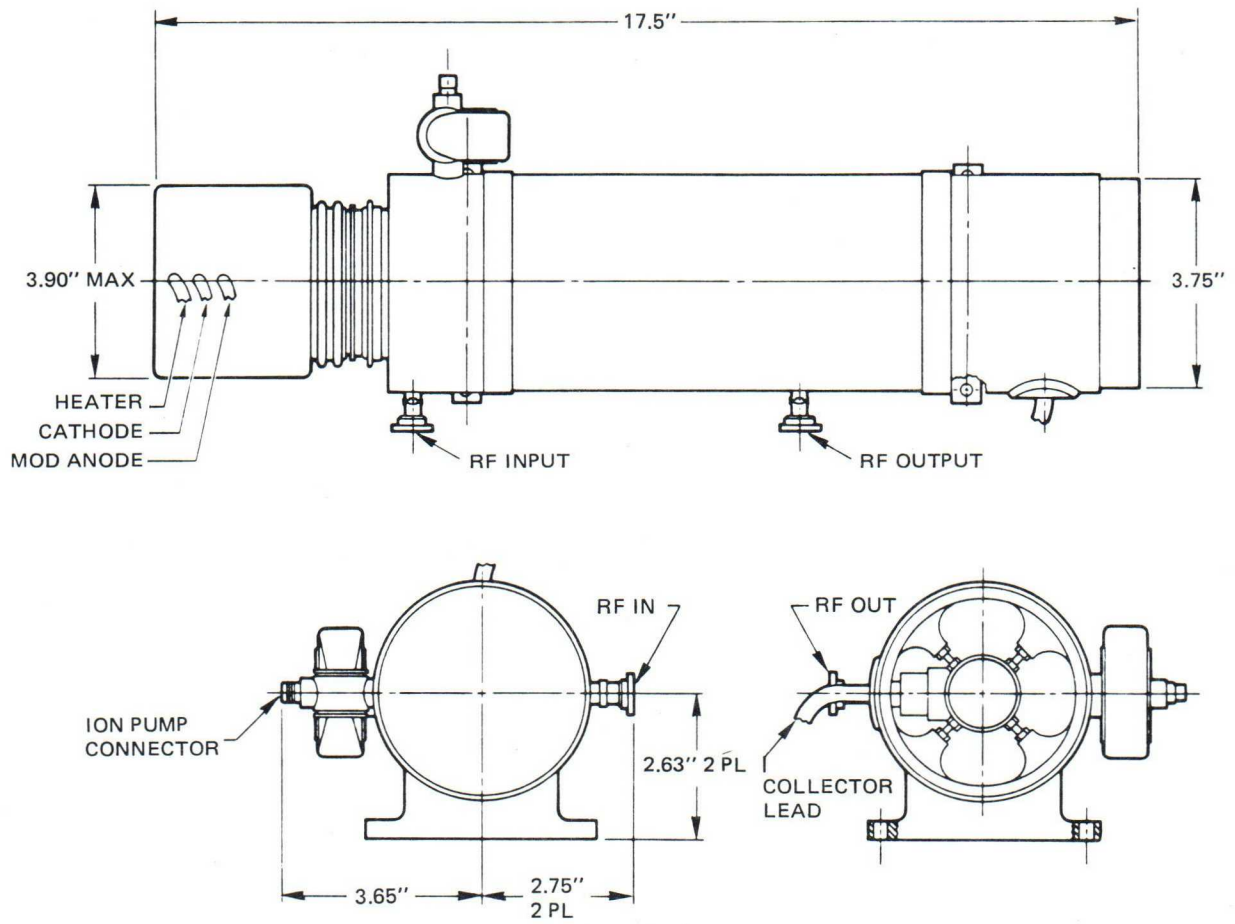

Figure 2-3 914H installation control drawing.

951H Ka-Band TWT

The 951H is a ferruleless coupled-cavity TWT developed for ground-terminal satellite uplink communication. The TWT produces 400 watts of CW power output over the 29.0 to 30.0 GHz frequency band. The electron gun employs a mod anode electron gun, and the beam is PPM focused. A single-stage depressed collector is used to increase the overall efficiency, and the tube is liquid cooled.

The 951H operating characteristics are listed in Table 2-2. Power output versus frequency is shown in Figure 2-4. The phase linearity performance of the 951H is shown in Figure 2-5. A photograph of the PPM-focused 951H TWT is shown in Figure 2-6. An installation control drawing is shown in Figure 2-7.

TABLE 2-2
OPERATING CHARACTERISTICS OF THE 951H

<u>RF Characteristics</u>	
Frequency	29.0 to 30.0 GHz
Power Output	400 watts
Gain	50 dB
Duty	CW
<u>Electrical Characteristics</u>	
Cathode Voltage	-24.5 kV
Cathode Current	0.2 A
Body Current	0.005 A
Collector Voltage	-12.5 kV
Anode Voltage	0 to +200 V
Heater Voltage	7.5 V
Heater Current	1.4 A

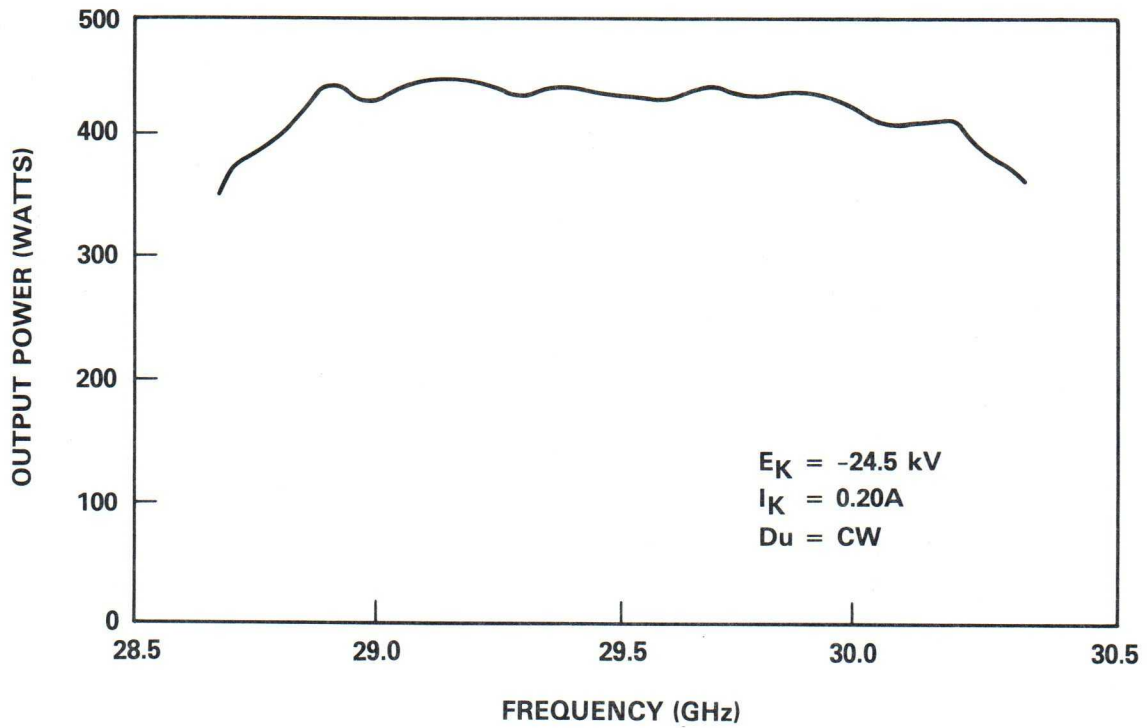

Figure 2-4 Power output vs frequency for the 951H TWT.

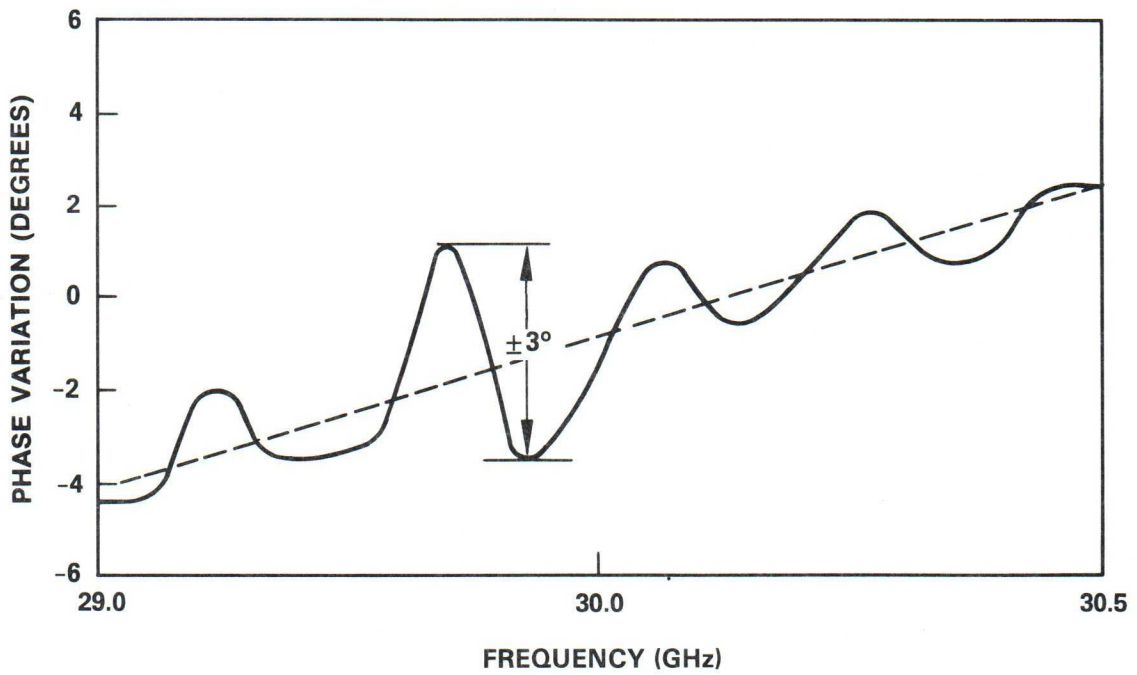

Figure 2-5 951H nonlinear phase variation with frequency.

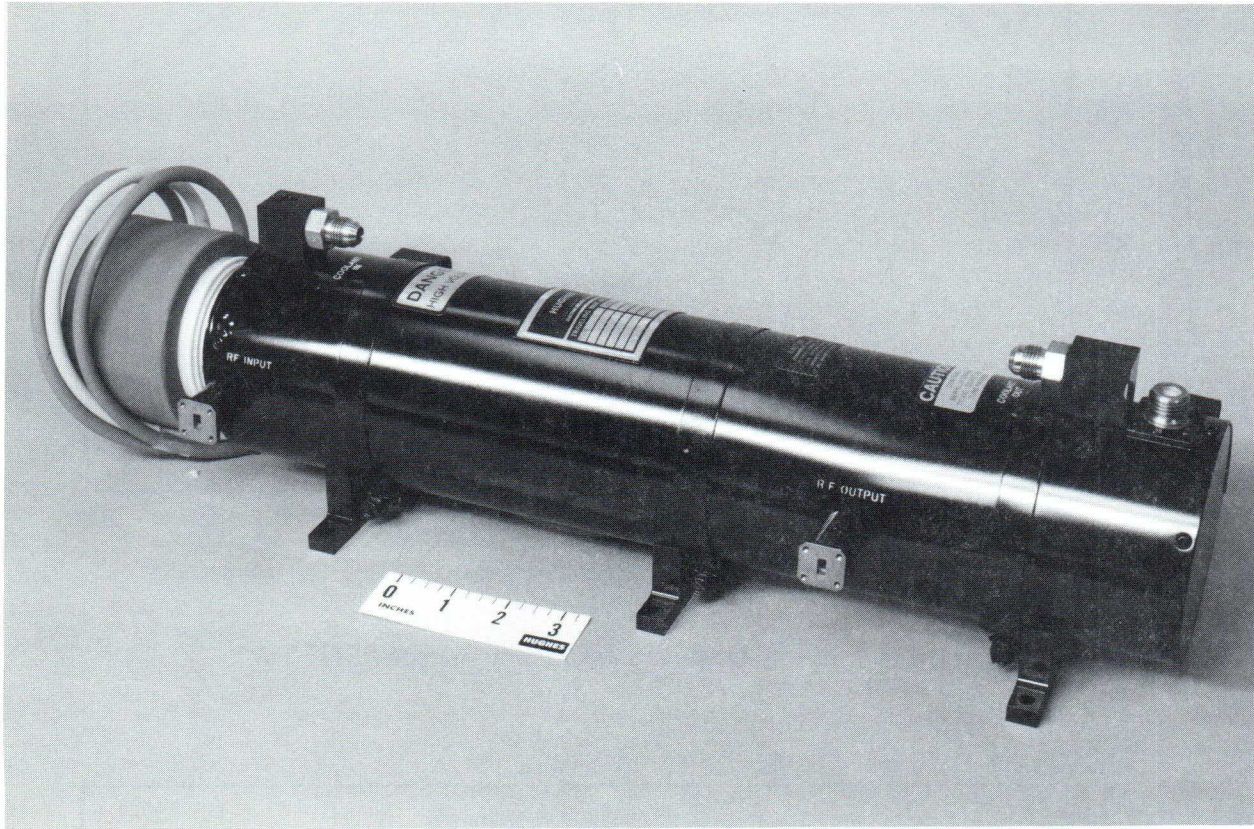

Figure 2-6 Photograph of 951H TWT.

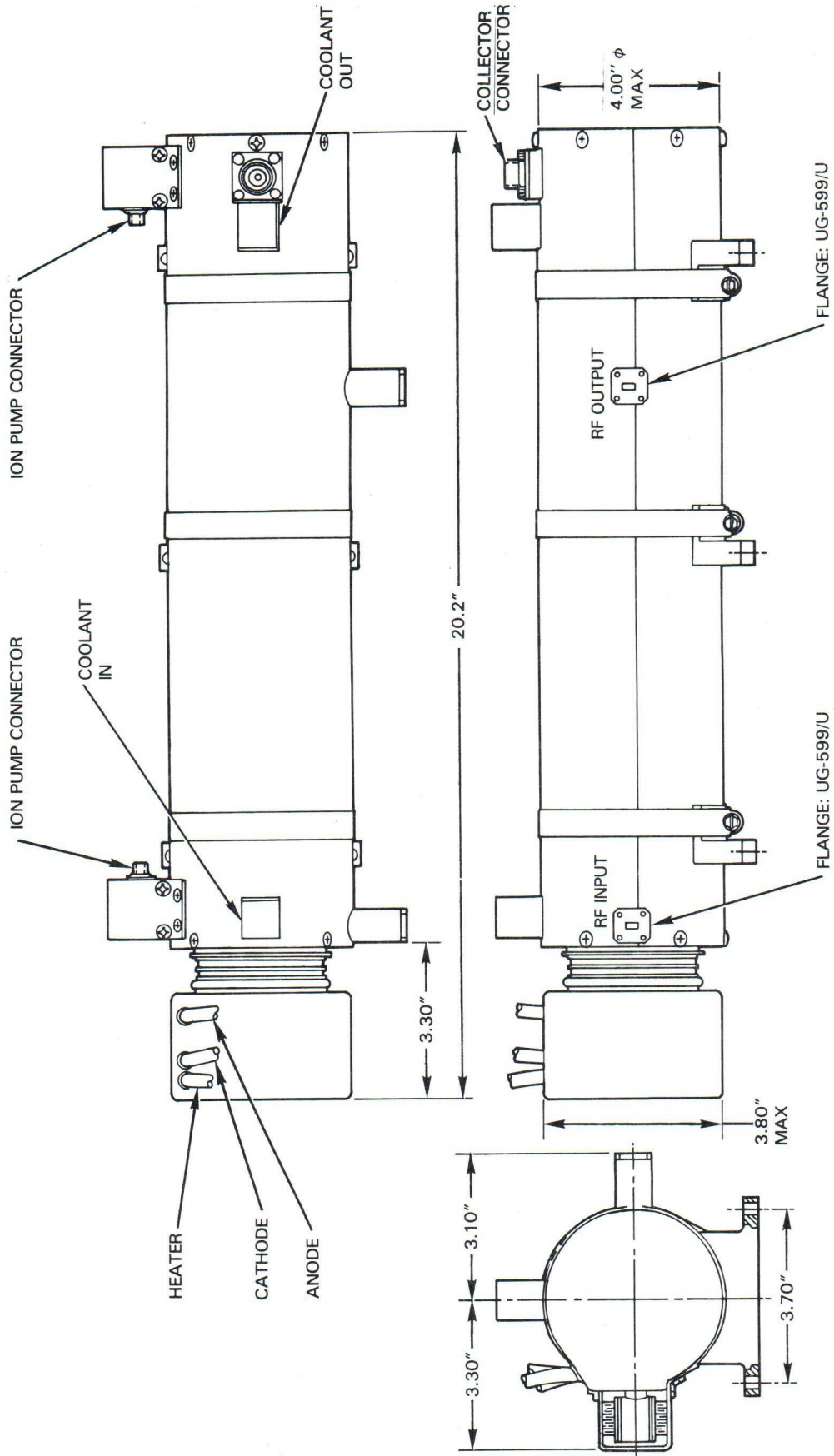

Figure 2-7 951H installation control drawing.

933H Ka-Band TWT

The 933H is a 1.0 kW, CW TWT developed for ground terminal communication application. The tube incorporates a small, lightweight, integrally wrapped solenoid. The overall tube weight is 55 pounds. The 933H features deionized water cooling and a single-stage depressed collector for efficiency enhancement. The electron gun incorporates a mod anode and operates at a low cathode loading, 2.0 A/cm² for long life. A summary of the operating parameters of the 933H TWT is given in Table 2-3.

933H TWT power output versus frequency performance is shown in Figure 2-8. A photograph of the 933H TWT is shown in Figure 2-9. An installation control drawing is shown in Figure 2-10.

TABLE 2-3
OPERATING CHARACTERISTICS OF THE 933H

<u>RF Characteristics</u>	
Frequency	30.0 to 31.0 GHz
Power Output	1.0 kW
Gain	35 dB
Duty	CW
<u>Electrical Characteristics</u>	
Cathode Voltage	-28.0 kV
Cathode Current	0.6 A
Body Current	0.015 A
Collector Voltage	-12.0 kV
Anode Voltage	0 to +200 V
Heater Voltage	7.0 V
Solenoid Voltage	100 V
Solenoid Current	15.0 A

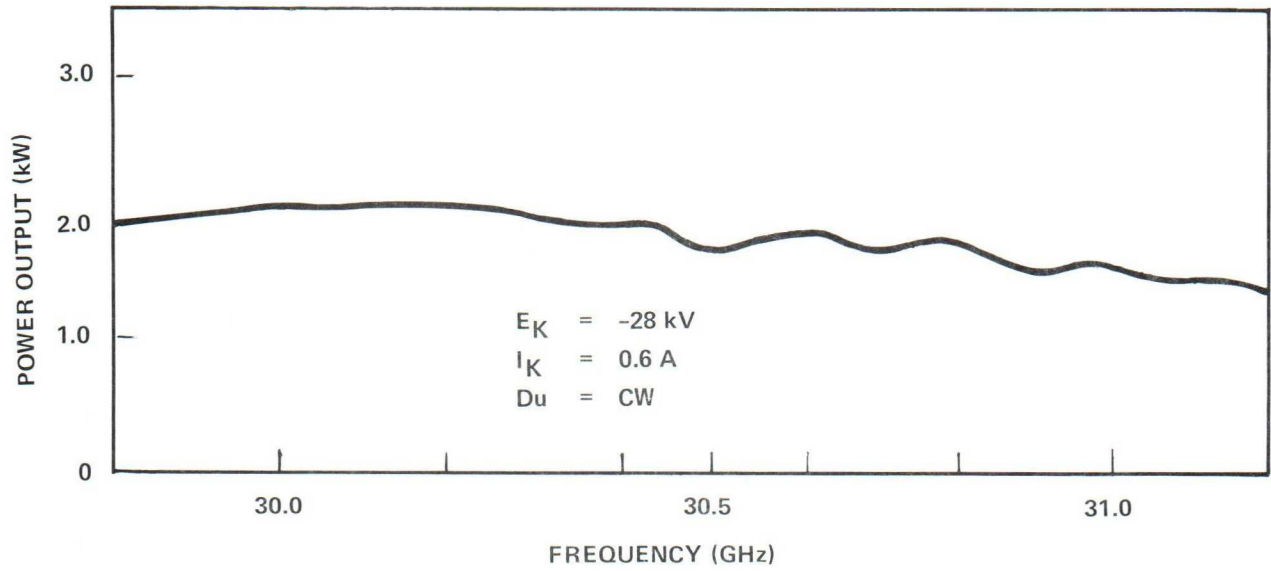

Figure 2-8 Power output vs frequency for the 933 TWT.

08-85562

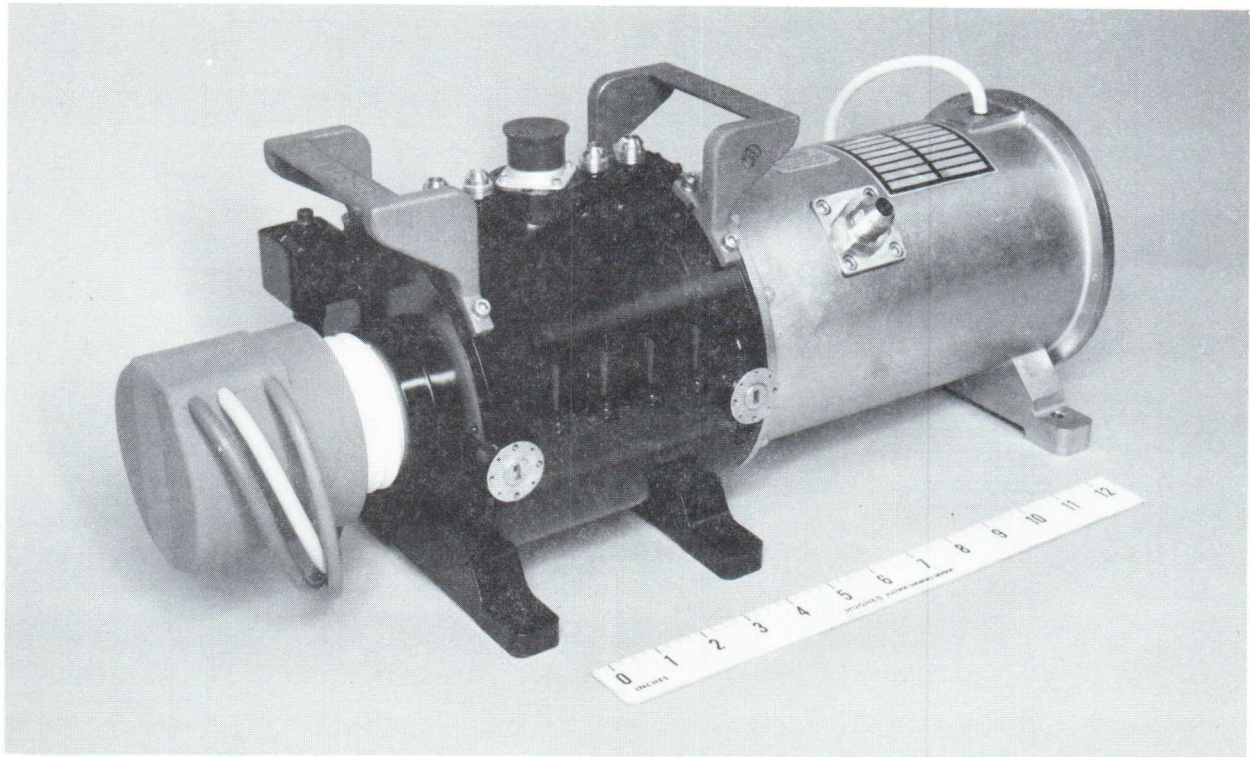

Figure 2-9 Photograph of 933 TWT.

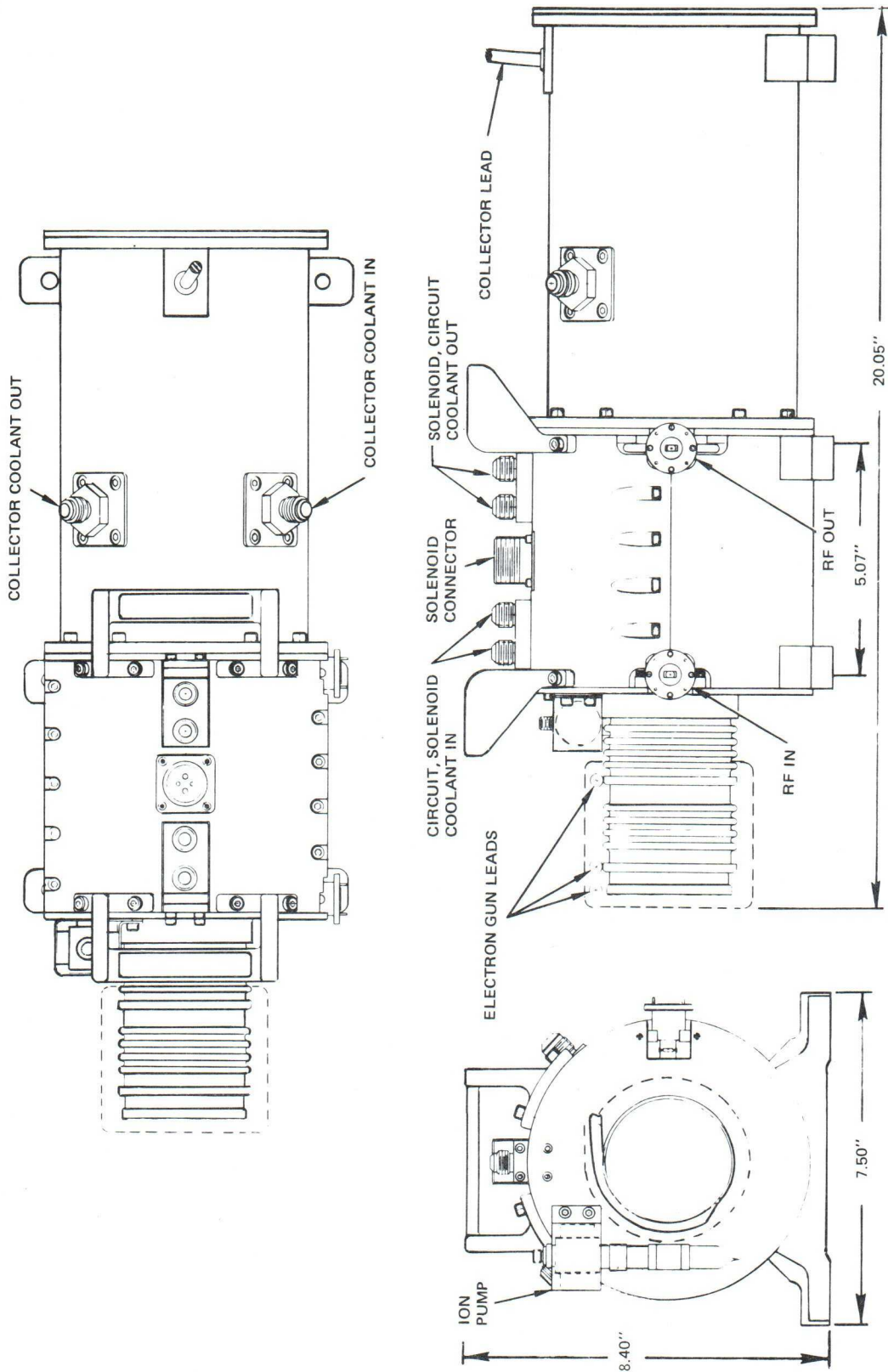

Figure 2-10 933H installation control drawing.

913H Ka-Band TWT

The 913H is an air-cooled coupled-cavity traveling-wave tube producing 100 watts of CW power output over the 36.44 to 38.44 GHz frequency band. The beam is controlled using a mod anode, and beam focusing is accomplished using periodic permanent magnets (PPM). A summary of the operating characteristics is given in Table 2-4. The 913H operates with depressed collector. Power output versus frequency performance is shown in Figure 2-11. A photograph of the 913H is shown in Figure 2-12. An installation control drawing is shown in Figure 2-13.

TABLE 2-4
OPERATING CHARACTERISTICS OF THE 913H

<u>RF Characteristics</u>	
Frequency	36.44 to 38.44 GHz
Power Output	100 watts
Gain	45 dB
Duty	CW
<u>Electrical Characteristics</u>	
Cathode Voltage	-16.0 kV
Cathode Current	0.078 A
Collector Voltage	-9.0 kV
Collector Current	0.071 A
Body Current	0.007 A
Heater Voltage	6.0 V
Heater Current	1.0 A

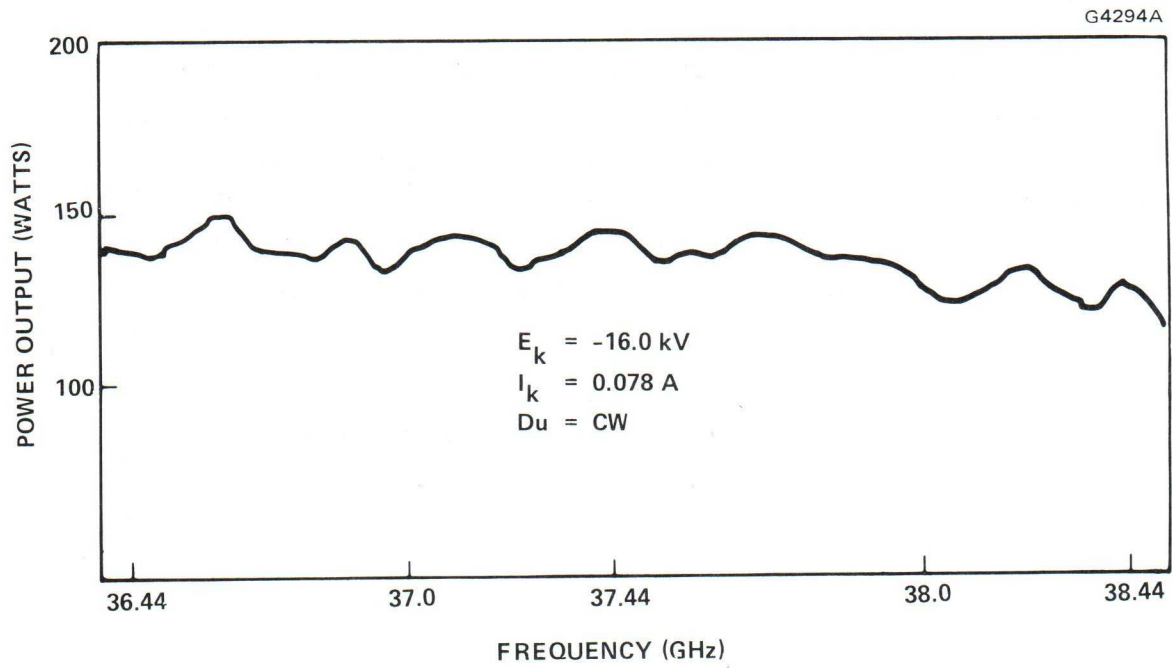

Figure 2-11 913H power output vs frequency.

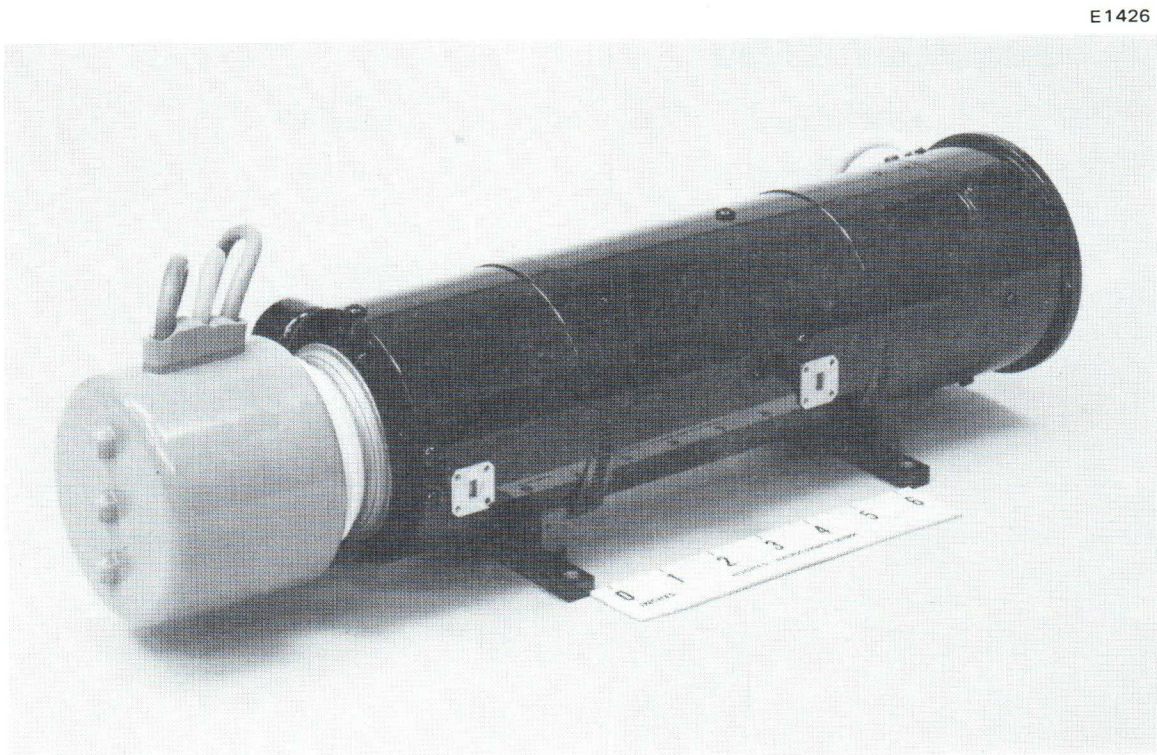

Figure 2-12 Photograph of 913 TWT.

G10857A

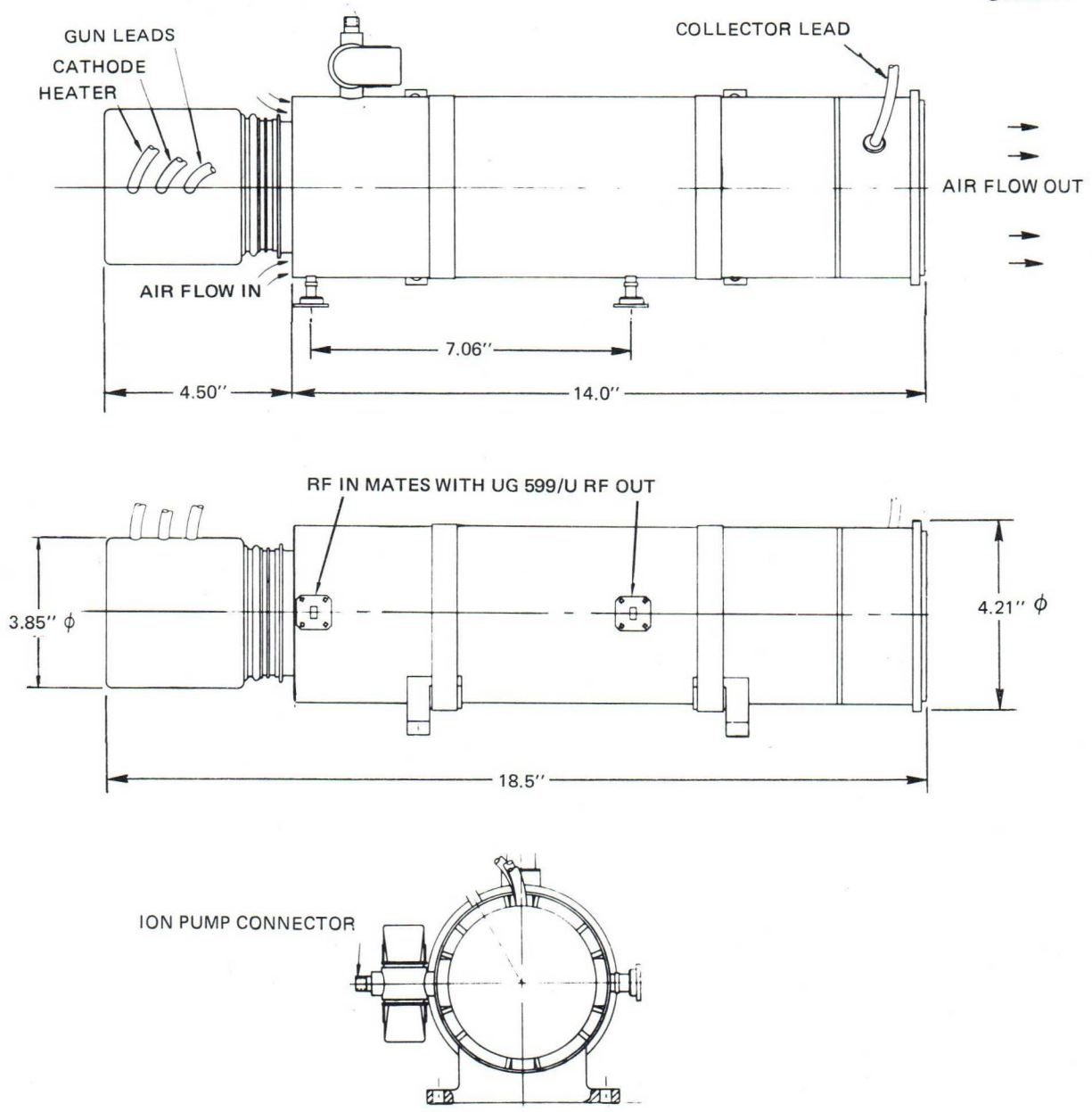

Figure 2-13 913H installation control drawing.

8910H Ka-Band TWT

The 8910H is a 4.0 kW, pulsed Ka-band TWT. Beam modulation is provided by a shadow-gridded electron gun. The tube is designed for PPM focusing and a single-stage depressed collector. A beam scraper is used to increase the thermal ruggedness of the tube. Both liquid- and air-cooled versions of the 8910H are available.

The 8910H TWT produces 4.0 kW of power output over a 10-percent bandwidth. The 8910H operating characteristics are listed in Table 2-5.

The RF performance at 5 percent duty cycle is shown in Figure 2-14. A photograph of the 8910H is shown in Figure 2-15, and an installation control drawing of the air cooled tube is presented in Figure 2-16.

TABLE 2-5
OPERATING CHARACTERISTICS OF THE 8910H

<u>RF Characteristics</u>	
Frequency	33.5 to 36.5 GHz
Power Output	4.0 kW
Gain	45 dB
Duty	5%
<u>Electrical Characteristics</u>	
Cathode Voltage	-37 kV
Cathode Current	1.2 A
Collector Voltage	-18 kV
Body Current	0.25 A
Grid Pulse Voltage	300 V
Grid Bias Voltage	-400 V

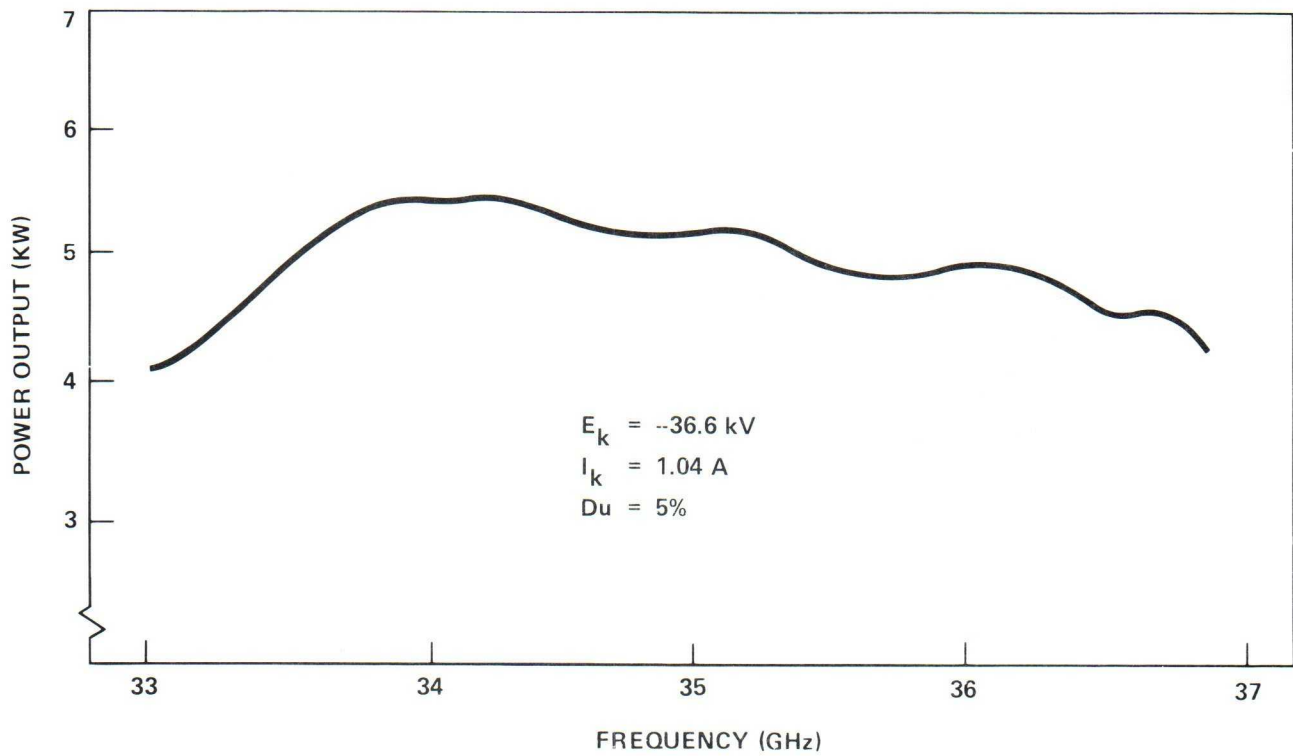

Figure 2-14 Power output vs frequency for the 8910H TWT.

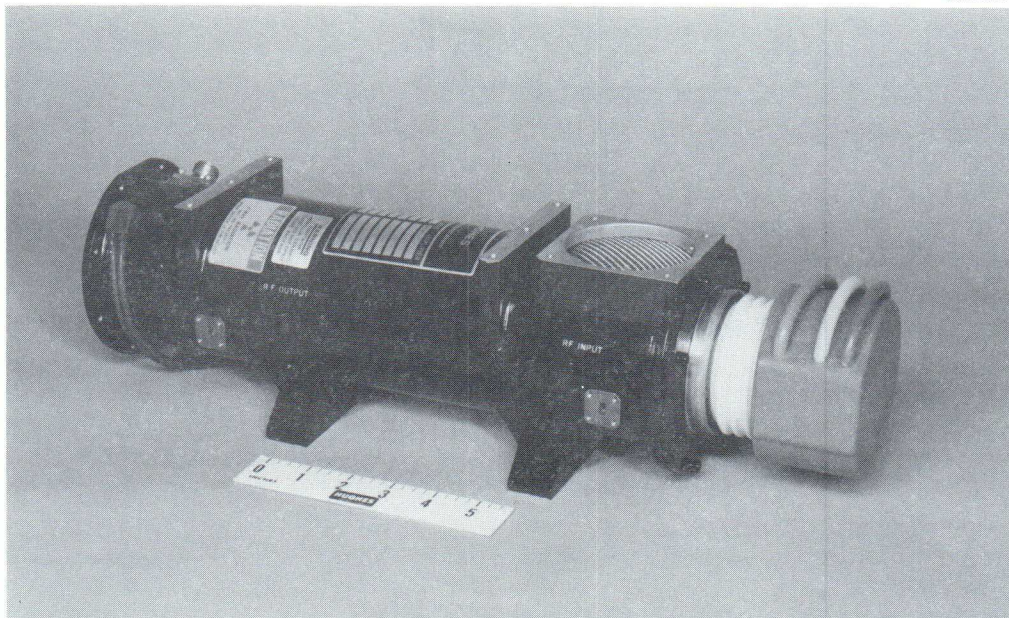

Figure 2-15 Photograph of air cooled 8910H TWT.

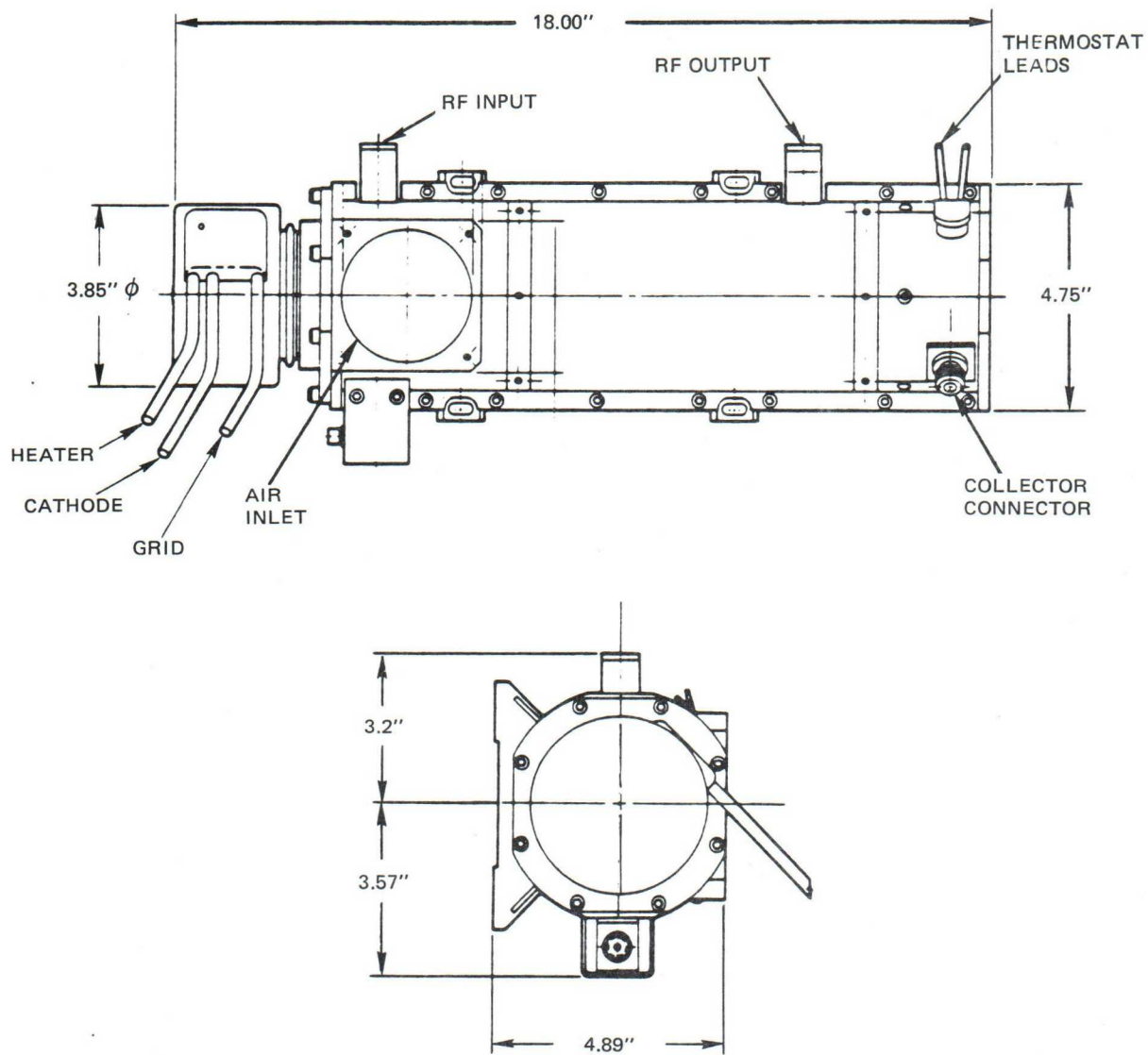

Figure 2-16 8910H installation control drawing.

3.0 Q-BAND TWTS

944H Q-Band TWT

The 944H is a 100 watt CW TWT operating over the 42.0 to 42.5 GHz frequency band. The tube is designed for long life at 1.0 A/cm² cathode loading. The 944H is PPM focused and utilizes a single-stage depressed collector for efficiency enhancement. A summary of the operating parameters of the 944H TWT is given in Table 3-1.

944H TWT power output versus frequency performance is shown in Figure 3-1. A photograph of the air-cooled 944H is shown in Figure 3-2. An installation control drawing is shown in Figure 3-3.

TABLE 3-1
OPERATING CHARACTERISTICS OF THE 944H

<u>RF Characteristics</u>	
Frequency	42.0 to 42.5 GHz
Power Output	100 watts
Gain	50 dB
Duty	CW
<u>Electrical Characteristics</u>	
Cathode Voltage	-14.5 kV
Cathode Current	0.046 A
Collector Voltage	-8.0 kV
Collector Current	0.041 A
Body Current	0.005 A
Heater Voltage	6.0 V
Heater Current	1.0 A

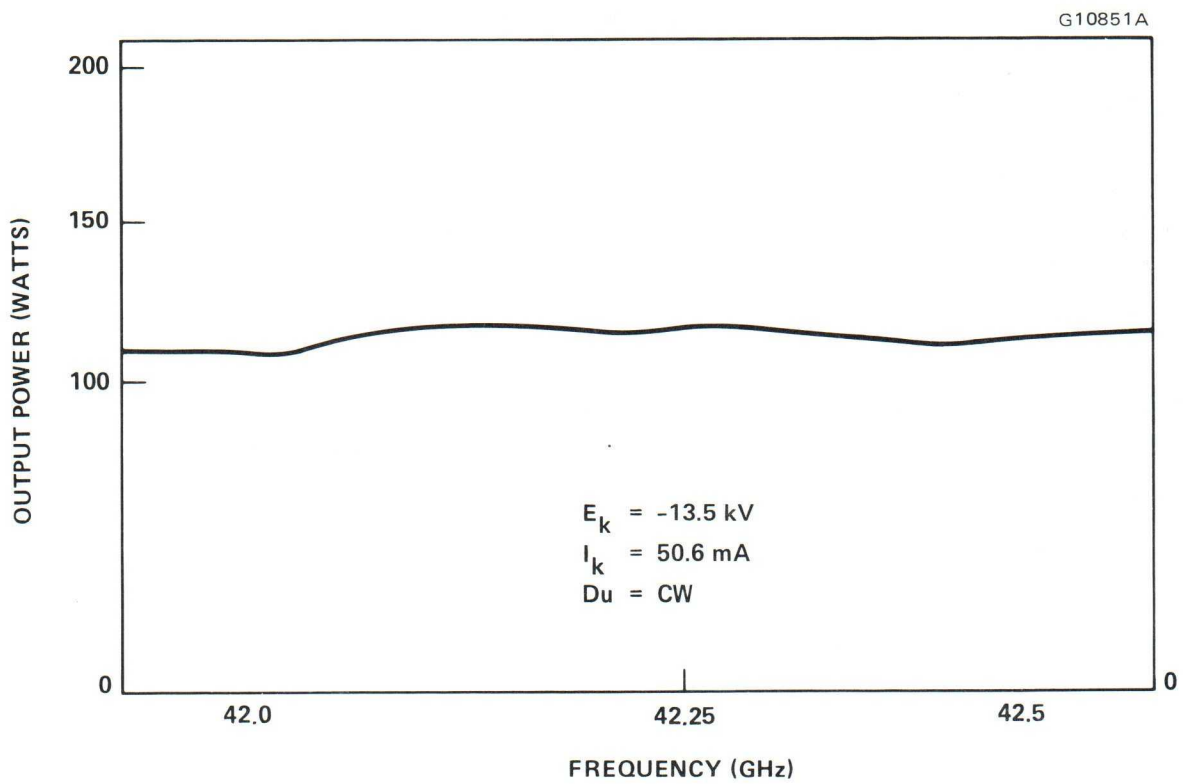

Figure 3-1 944H power output vs frequency.

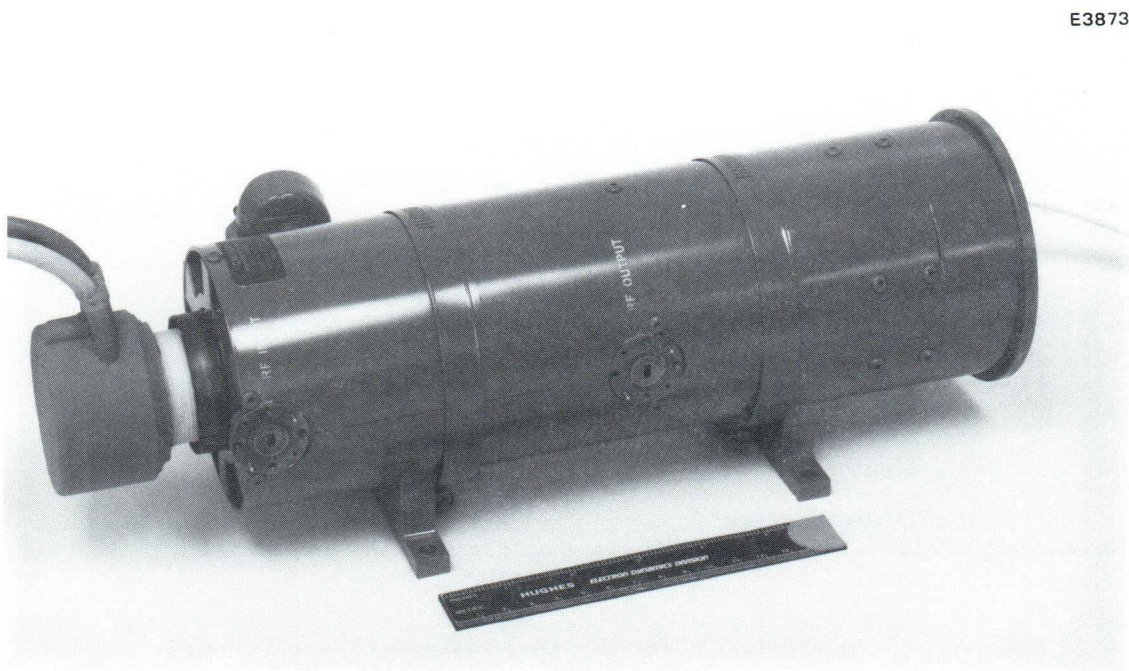

Figure 3-2 Photograph of 944H TWT.

G10701A

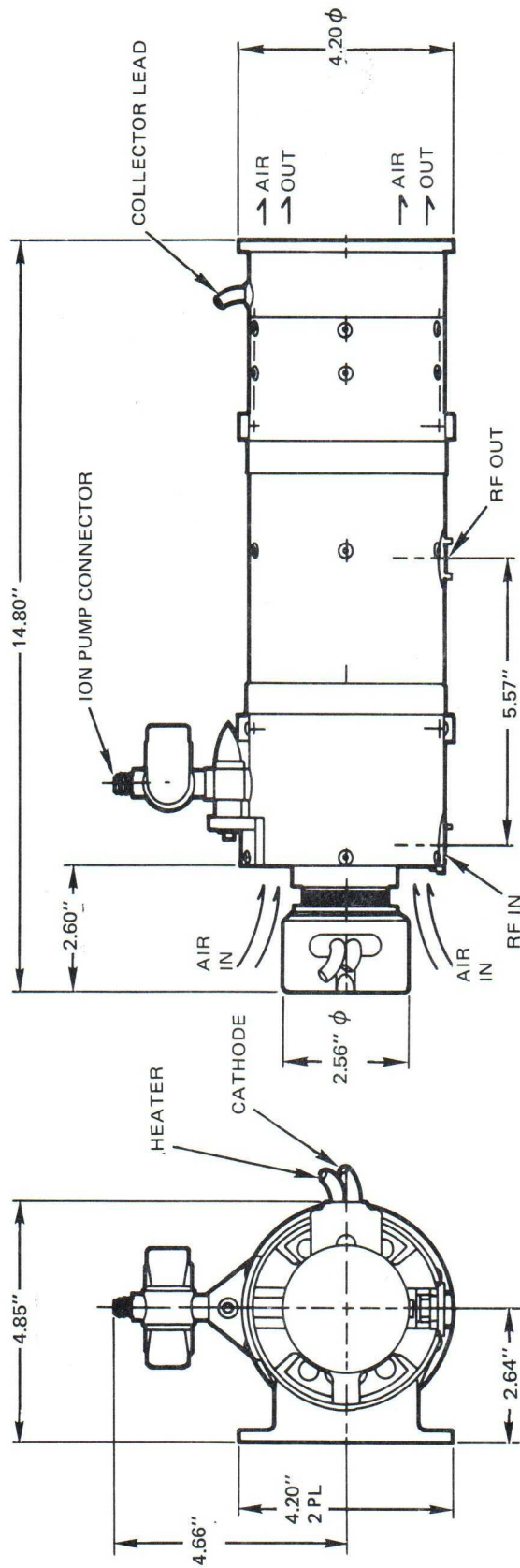

Figure 3-3 944H installation control drawing.

946H Q-Band TWT

The 946H TWT is a 100 watt, CW TWT that operates over the 43.5 to 45.5 GHz frequency band. The tube features a ferruleless cavity structure and is packaged for conduction cooling to a base-plate. The beam is PPM focused, and the electron gun incorporates a mod anode. To enhance the overall efficiency, the 946H employs a single-stage depressed collector.

The operating characteristics of the 946H TWT are listed in Table 3-2. Power output versus frequency performance is shown in Figure 3-4. A photograph of a conduction-cooled 946H TWT is shown in Figure 3-5. An installation control drawing is shown in Figure 3-6.

TABLE 3-2
OPERATING CHARACTERISTICS OF THE 946H

<u>RF Characteristics</u>	
Frequency	43.5 to 45.5 GHz
Power Output	100 watts
Gain	50 dB
Duty	CW
<u>Electrical Characteristics</u>	
Cathode Voltage	-16.5 kV
Cathode Current	0.060 A
Collector Voltage	-9.0 kV
Collector Current	0.057 A
Body Current	0.003 A
Mod Anode Voltage	0 to +100 V
Heater Voltage	5.0 V
Heater Current	0.8 A

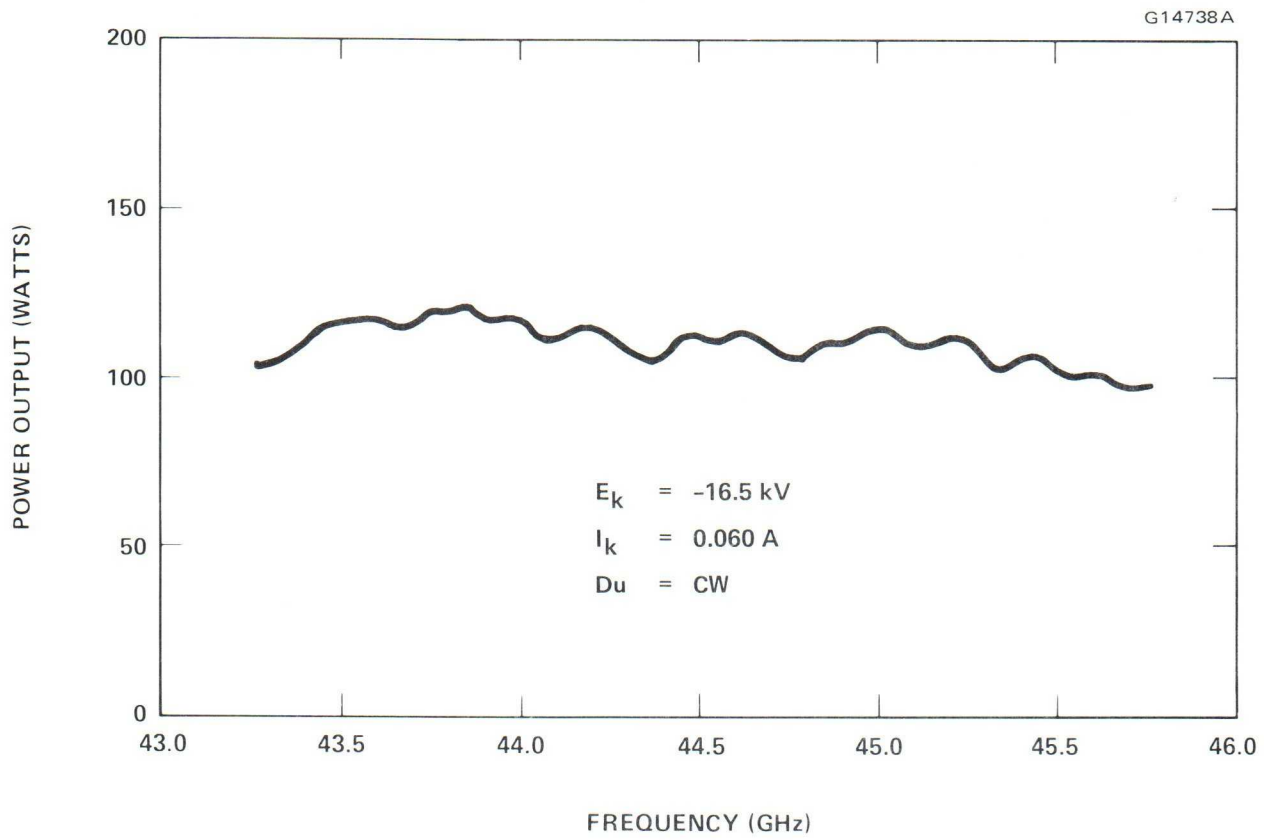

Figure 3-4 946H power output vs frequency.

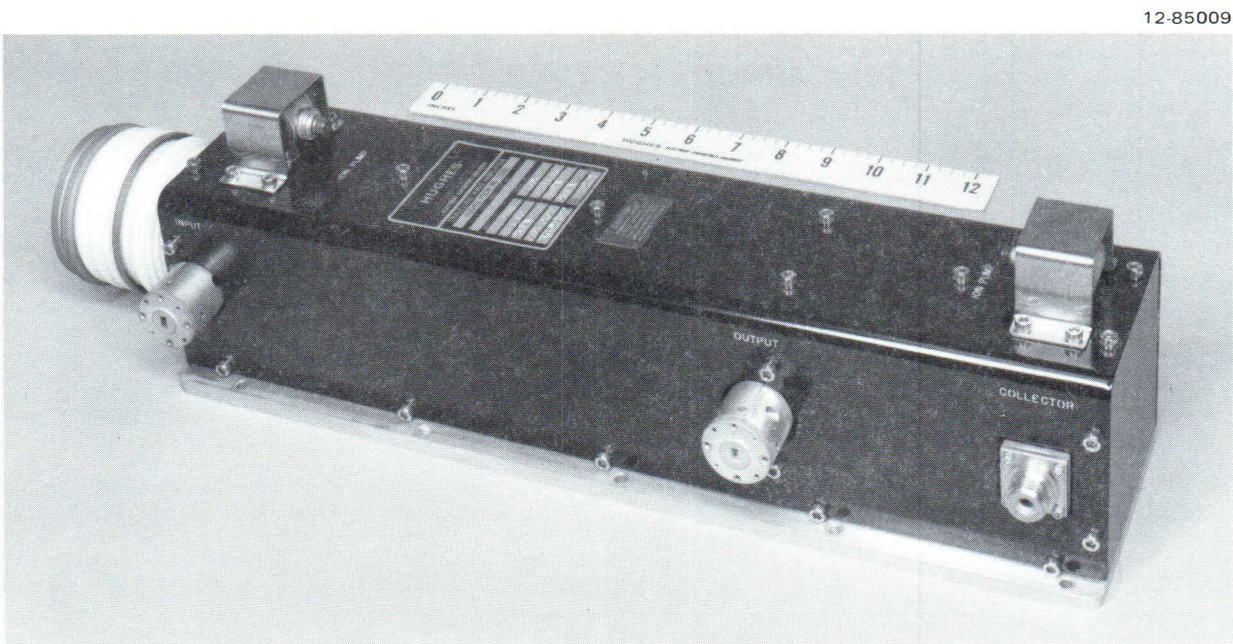

Figure 3-5 Photograph of 946H TWT.

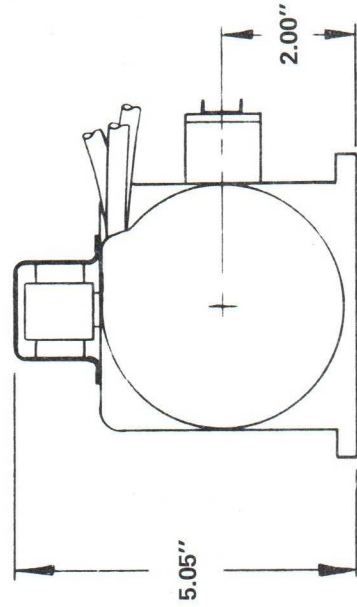
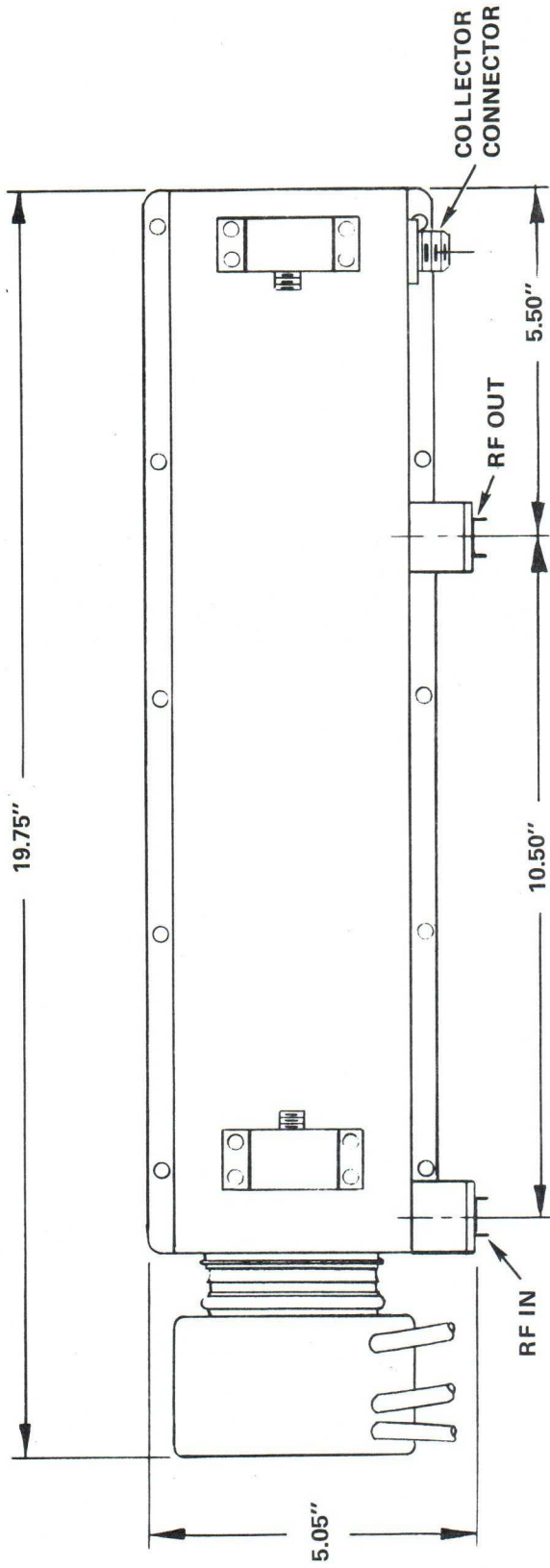

Figure 3-6 946H installation control drawing.

947H Q-Band TWT

The 947H is a ferruleless coupled-cavity TWT which produces 150 watts CW power output over the 43.5 to 45.5 GHz bandwidth. The tube employs PPM focusing, single-stage depressed collector, mod anode electron gun, and forced-air cooling.

The 947H TWT operating characteristics are listed in Table 3-3. CW power output versus frequency performance is shown in Figure 3-7. A photograph of the 947H TWT is shown in Figure 3-8. An installation control drawing is shown in Figure 3-9.

TABLE 3-3
OPERATING CHARACTERISTICS OF THE 947H

<u>RF Characteristics</u>	
Frequency	43.5 to 45.5 GHz
Power Output	150 W
Gain	50 dB
Duty	CW
<u>Electrical Characteristics</u>	
Cathode Voltage	-18.8 kV
Cathode Current	0.083 A
Collector Voltage	-12 kV
Collector Current	0.077 A
Body Current	0.006 A
Mod Anode Voltage	0 to +100 V
Heater Voltage	5.0 V
Heater Current	1.0 A

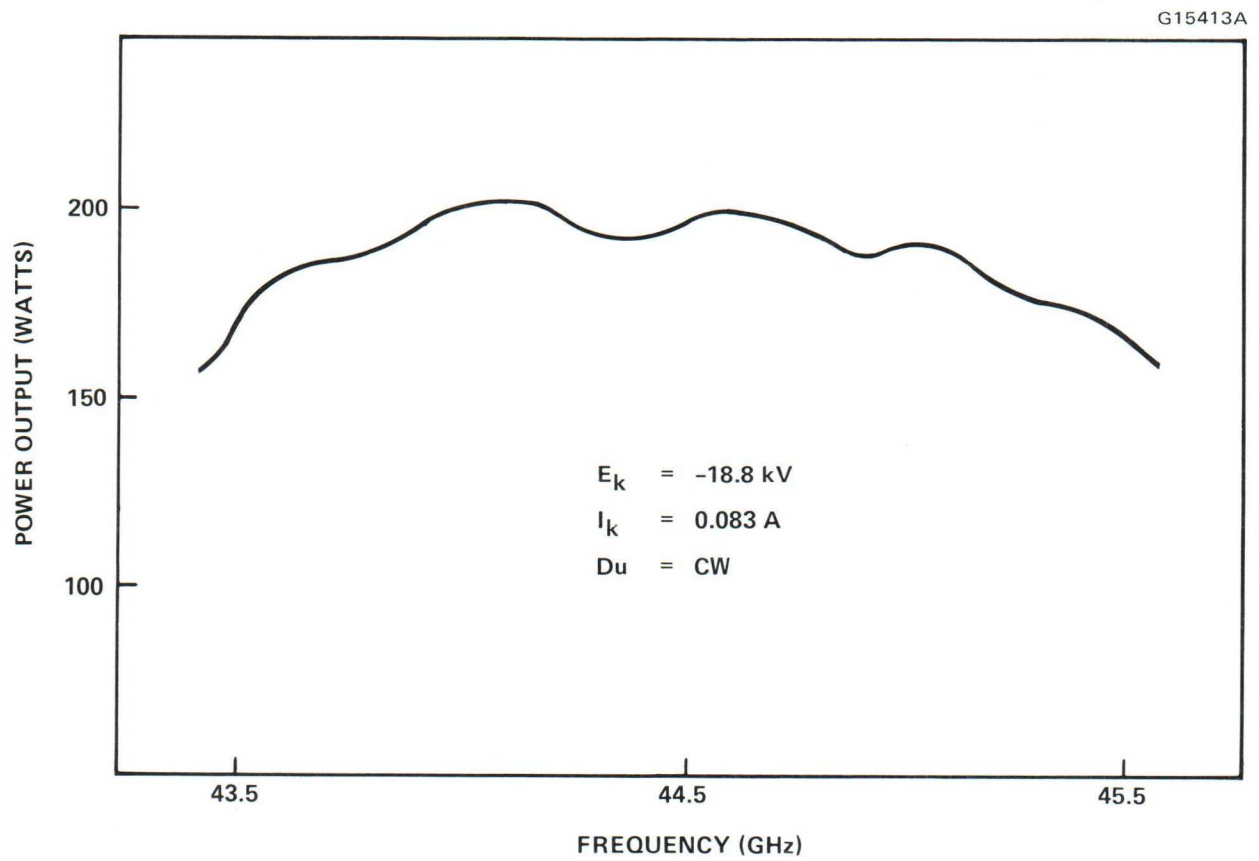

Figure 3-7 947H power output vs frequency.

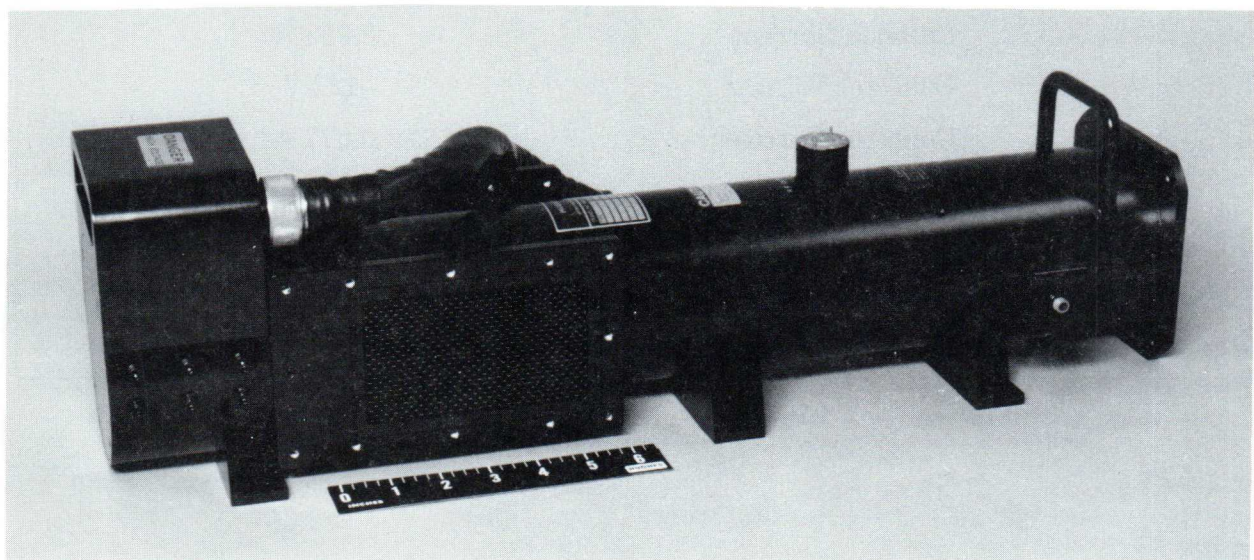

Figure 3-8 Photograph of 947H TWT.

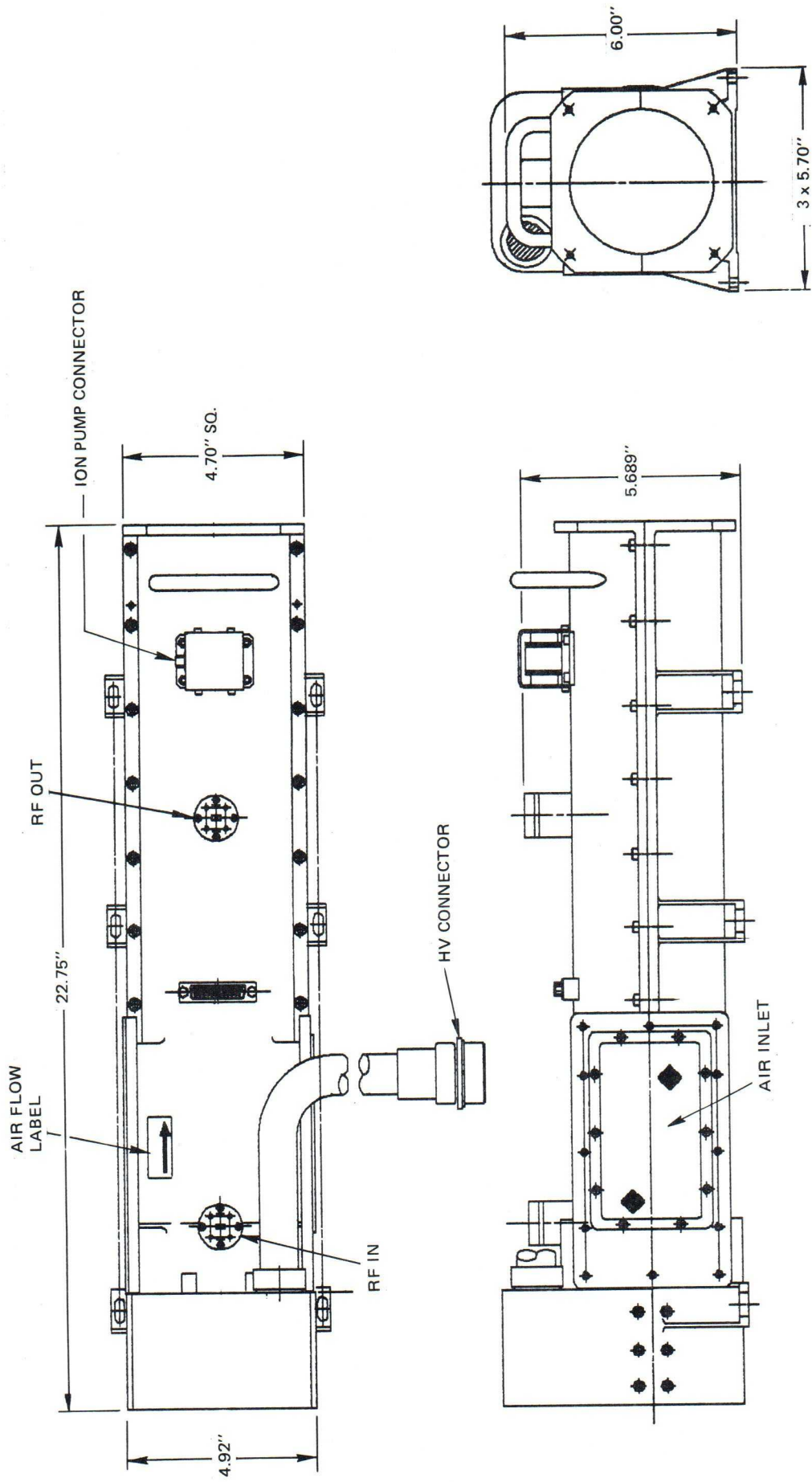

Figure 3-9 947H installation control drawing.

915H Q-Band TWT

The Hughes Model 915H is a high-power TWT providing 250 watts of CW power output over the 43.5 to 45.5 GHz frequency band. The electron gun for the 915H incorporates a mod anode; the focusing of the beam is provided by a PPM magnetic circuit; and a single-stage depressed collector is used to improve the tube efficiency (greater than 20 percent). A summary of the tube's operating characteristics is given in Table 3-4.

Typical power output performance is shown in Figure 3-10. A photograph of a packaged 915H TWT is shown in Figure 3-11, and the installation control drawing is shown in Figure 3-12. The 915H TWT is offered in both water-cooled and air-cooled configurations. With the exception of cooling differences, TWT interfaces are the same for either device.

TABLE 3-4
OPERATING CHARACTERISTICS OF THE 915H

<u>RF Characteristics</u>	
Frequency	43.5 to 45.5 GHz
Power Output	250 watts
Gain	50 dB
Duty	CW
<u>Electrical Characteristics</u>	
Cathode Voltage	-22.5 kV
Cathode Current	0.100 A
Collector Voltage	-12 kV
Collector Current	0.092 A
Body Current	0.008 A
Mod Anode Voltage	0 to +100 V
Heater Voltage	5.0 V
Heater Current	1.0 A

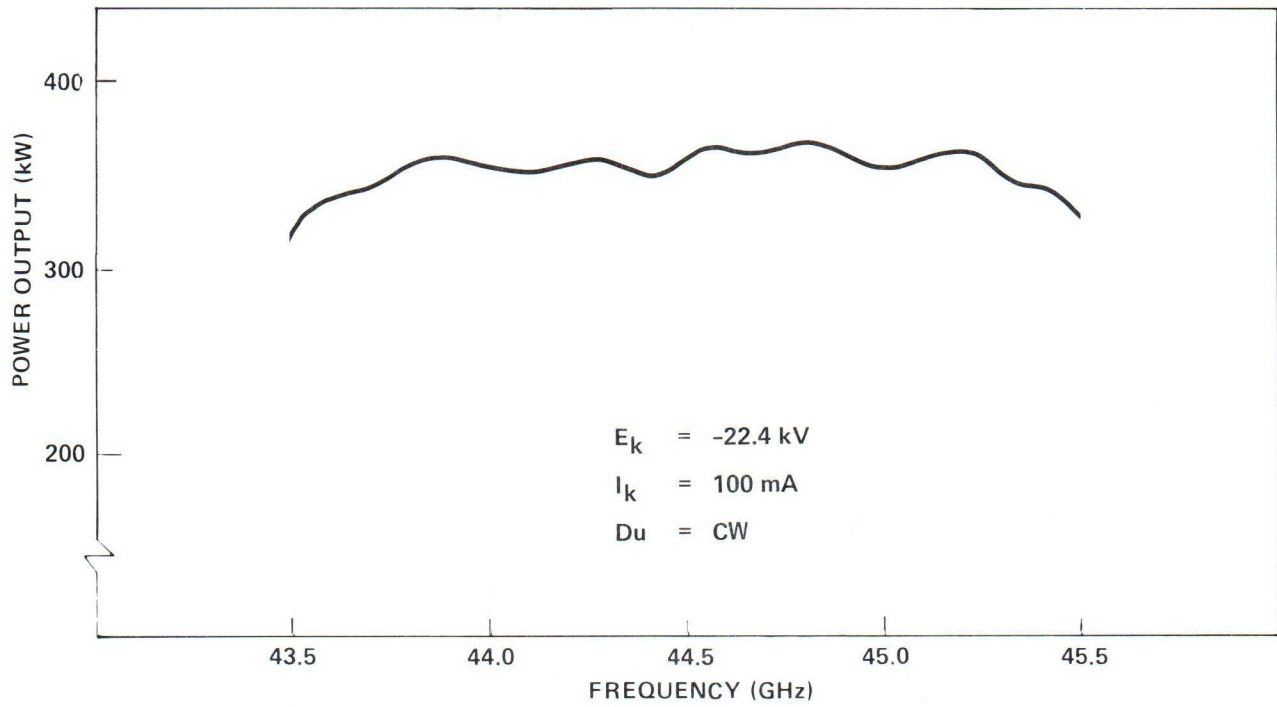

Figure 3-10 Power output vs frequency for the 915H TWT.

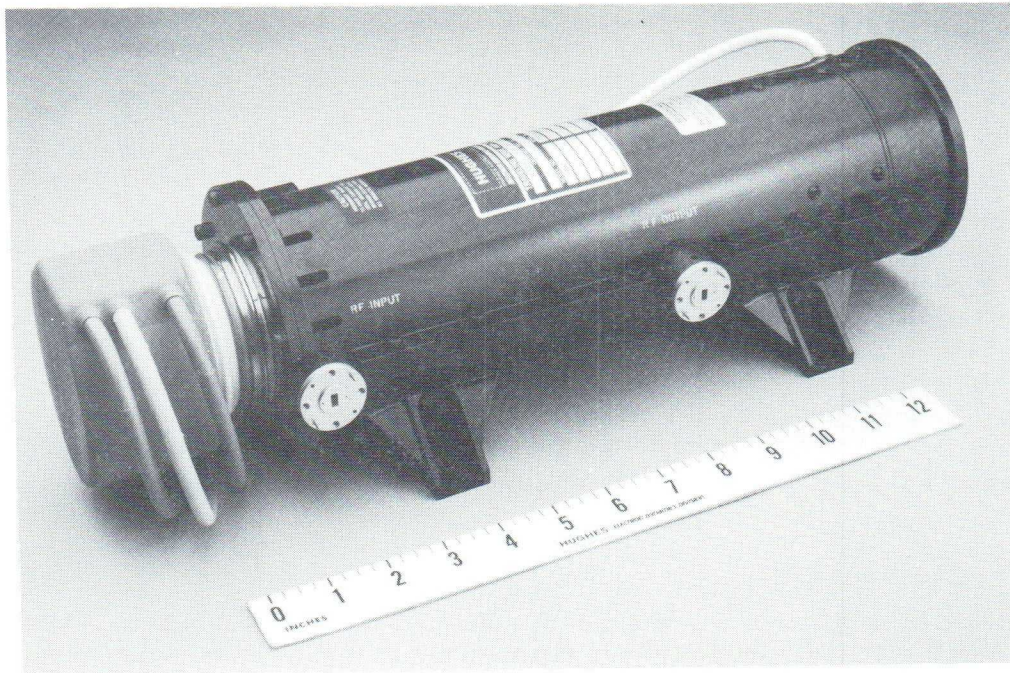

Figure 3-11 Photograph of 915H TWT.

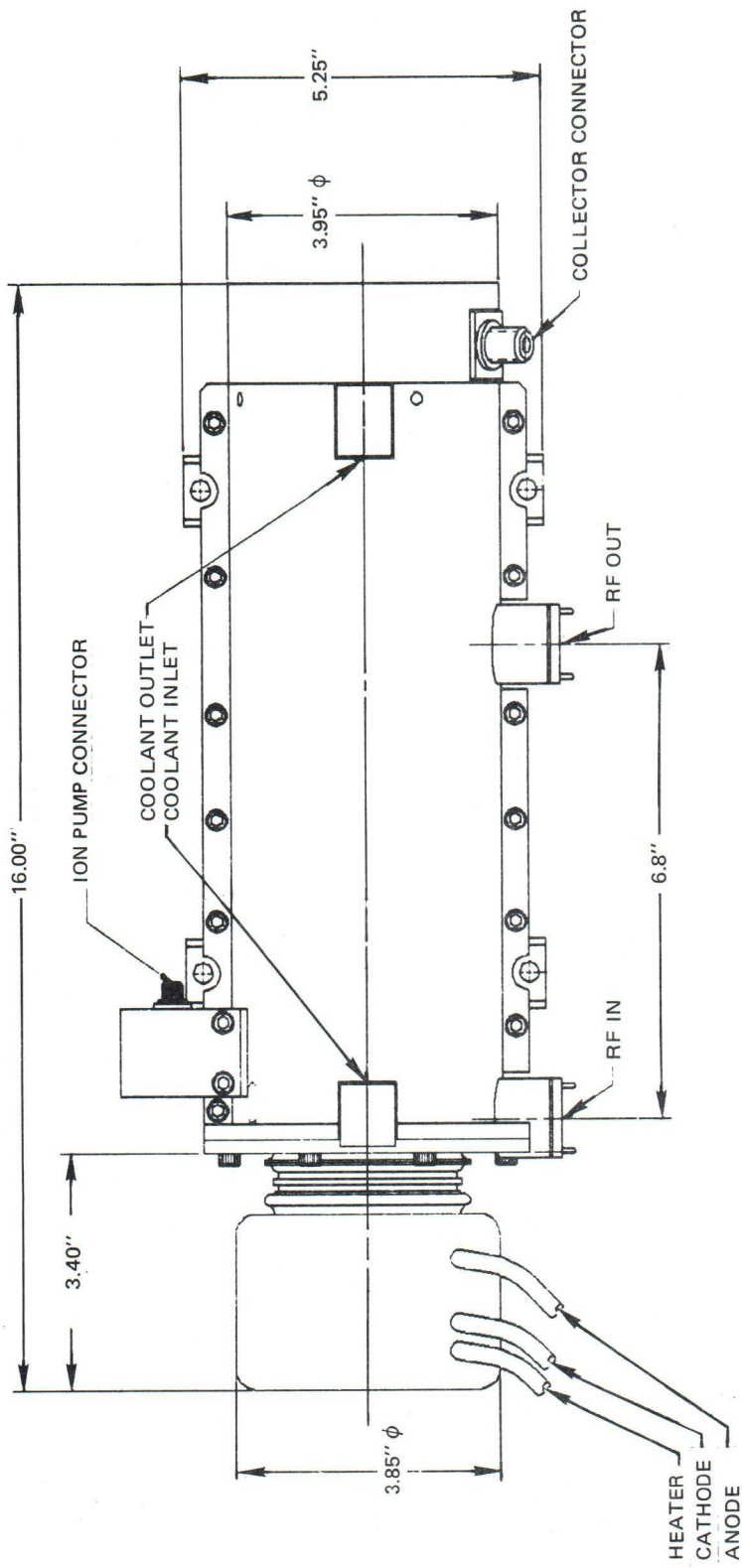

Figure 3-12 915H installation control drawing.

915HF Q-Band TWT

A modified configuration of the 915H TWT, designated the 915HF, has been developed that uses a ferruleless RF circuit. This tube is air cooled and designed to meet the same performance requirements as the 915H. The ferruleless circuit results in cavity parts consisting of a simple disc and washer assembly. The simplicity of these cavity parts will allow mass production at low parts cost. A schematic comparing the standard ferruled cavity and the ferruleless cavity is shown in Figure 3-13.

The 915HF uses the same proven mod anode electron gun, depressed collector, and PPM focusing circuit assemblies. Operating characteristics of the 915HF are given in Table 3-5 and are essentially identical to the 915H TWT. Power output versus frequency performance is shown in Figure 3-14. A photograph of the air cooled 915HF TWT is shown in Figure 3-15. An installation control drawing is shown in Figure 3-16. The ferruleless TWT can also be offered in a liquid-cooled configuration.

TABLE 3-5
OPERATING CHARACTERISTICS OF THE 915HF

<u>RF Characteristics</u>	
Frequency	43.5 to 45.5 GHz
Power Output	250 watts
Gain	50 dB
Duty	CW
<u>Electrical Characteristics</u>	
Cathode Voltage	-22.5 kV
Cathode Current	0.100 A
Collector Voltage	-11 kV
Collector Current	0.092 A
Body Current	0.008 A
Mod Anode Voltage	0 to +100 V
Heater Voltage	5.0 V
Heater Current	1.0 A

STANDARD

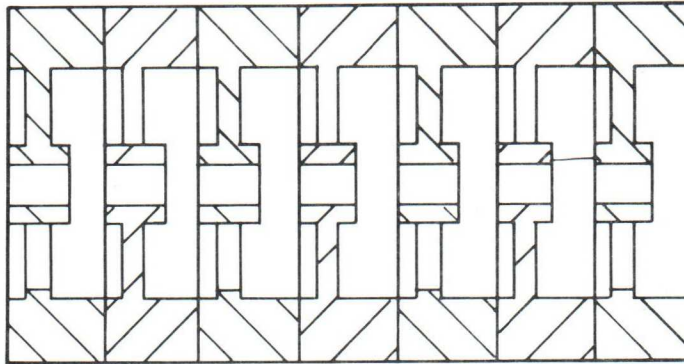

NON-REENTRANT

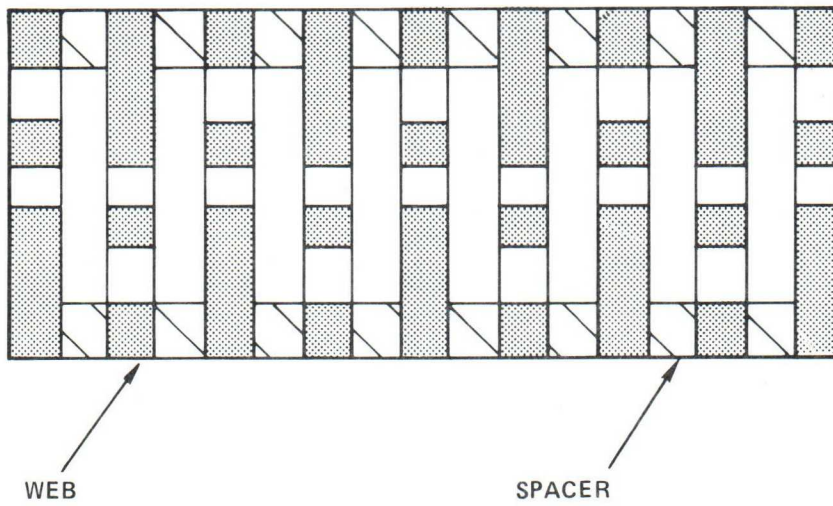

Figure 3-13 Schematics of standard and ferruleless RF circuit.

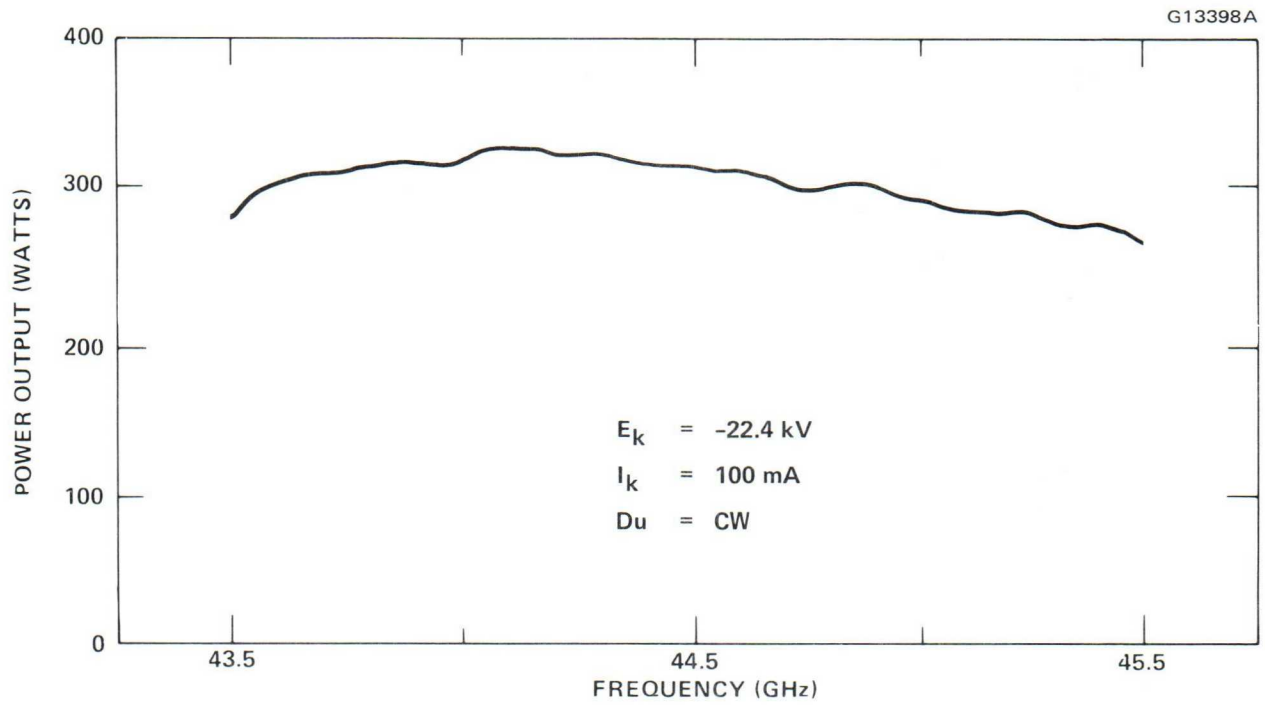

Figure 3-14 915HF power output vs frequency performance.

10-84501

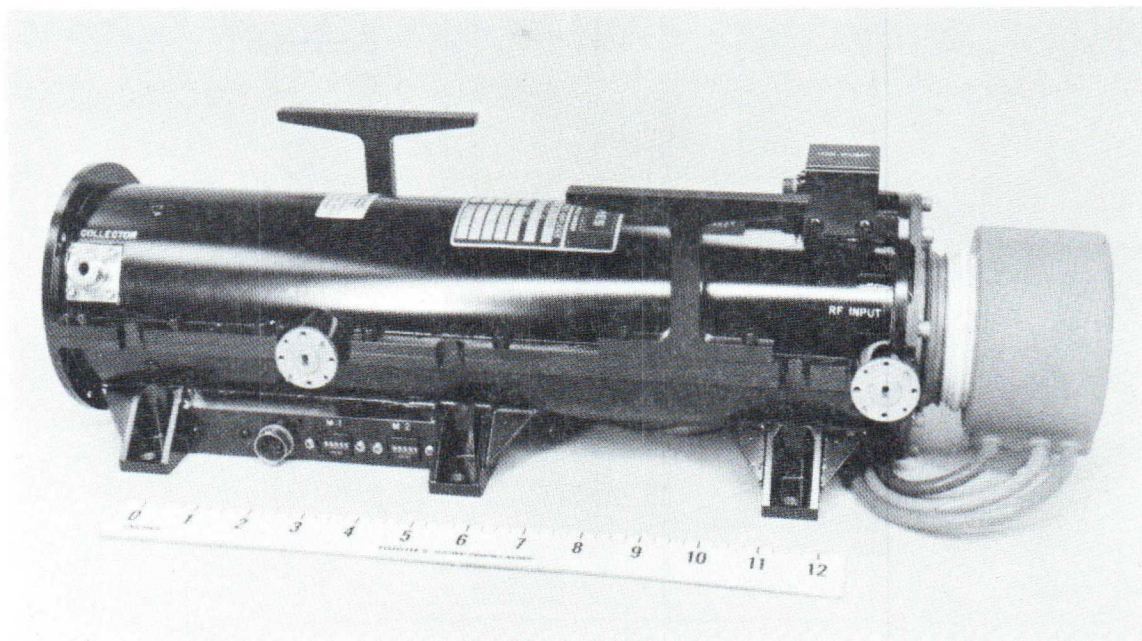

Figure 3-15 Photograph of 915HF TWT.

G14221A

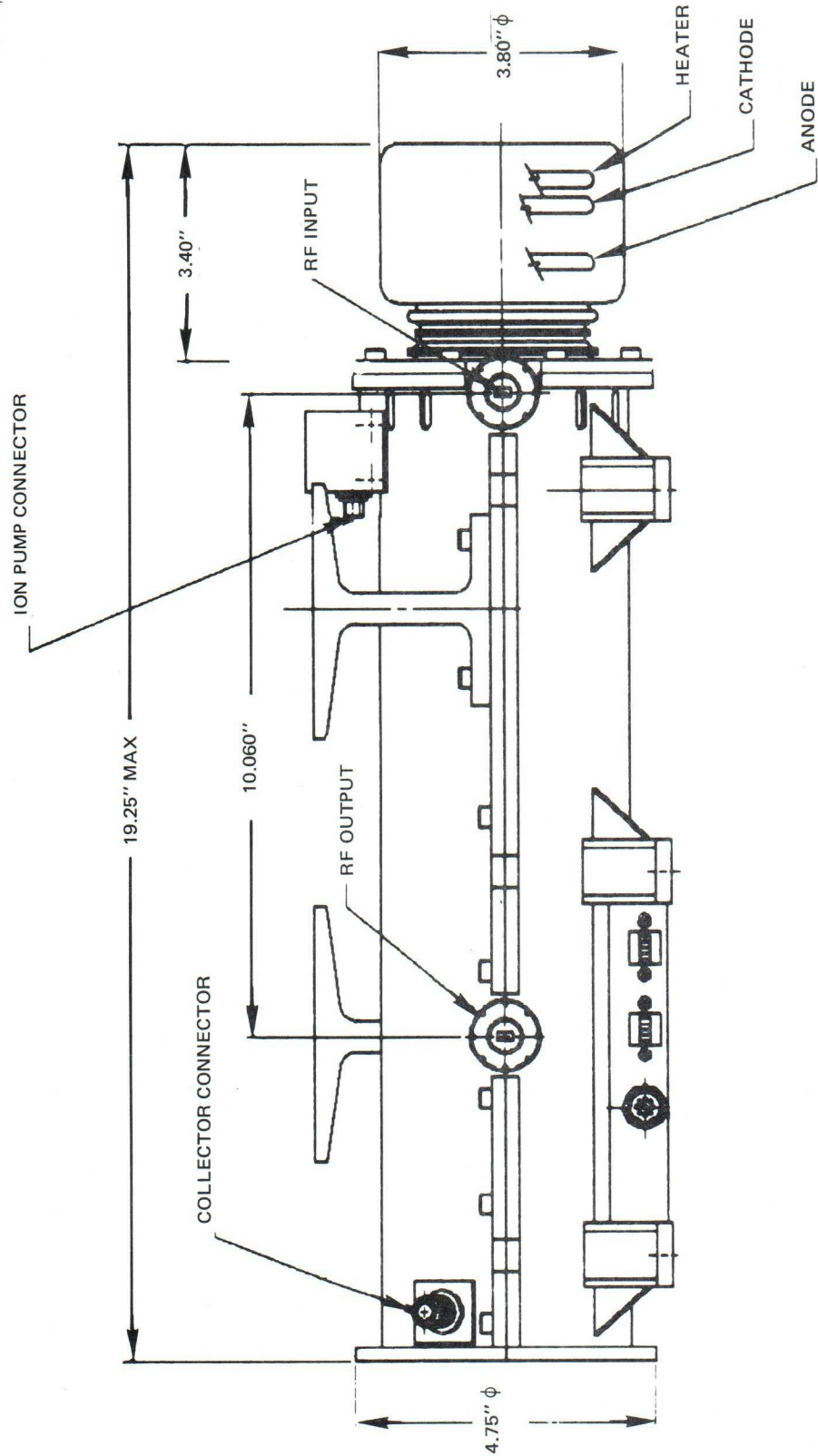

Figure 3-16 915HF installation control drawing.

4.0 V-BAND TWTS

960H V-Band TWT

The 960H TWT is a 5-watt CW device operating in the V-band frequency range. The tube is designed for long life applications with a cathode loading of 1.0 A/cm^2 . The tube is PPM focused and uses a single-stage depressed collector for improved efficiency.

The operating characteristics for the 960H are listed in Table 4-1. CW power output versus frequency is given in Figure 4-1. A photograph of an air-cooled 960H is shown in Figure 4-2. An installation control drawing is shown in Figure 4-3.

TABLE 4-1
OPERATING CHARACTERISTICS OF THE 960H

<u>RF Characteristics</u>	
Frequency	60 GHz
Power Output	5 watts
Gain	45 dB
Duty	CW
<u>Electrical Characteristics</u>	
Cathode Voltage	-8 kV
Cathode Current	0.020 A
Collector Voltage	-4 kV
Collector Current	0.017 A
Body Current	0.003 A
Heater Voltage	6.0 V
Heater Current	1.0 A

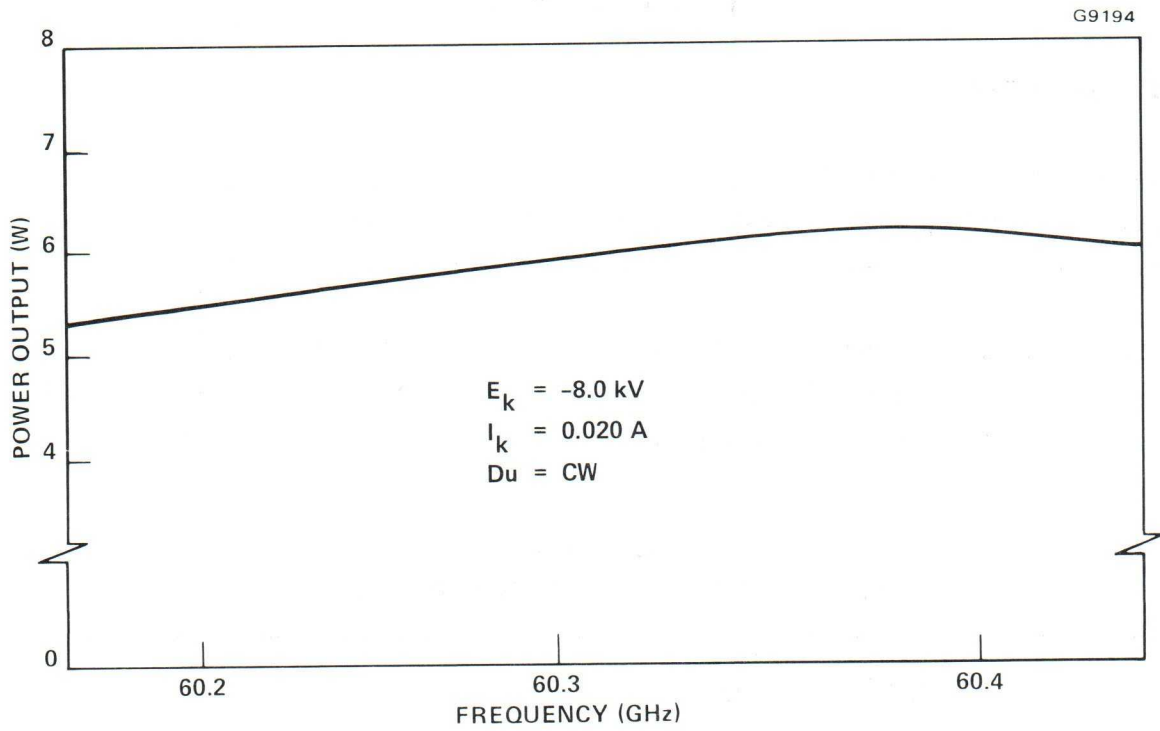

Figure 4-1 960H power output vs frequency.

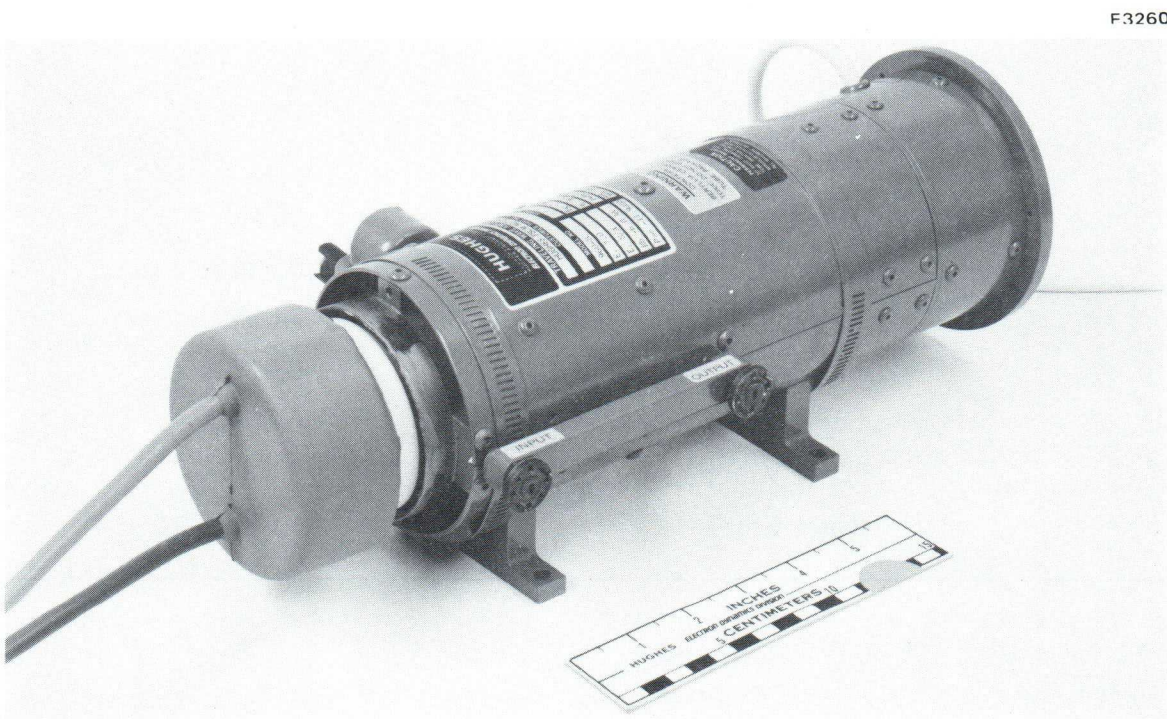

Figure 4-2 Photograph of 960H TWT.

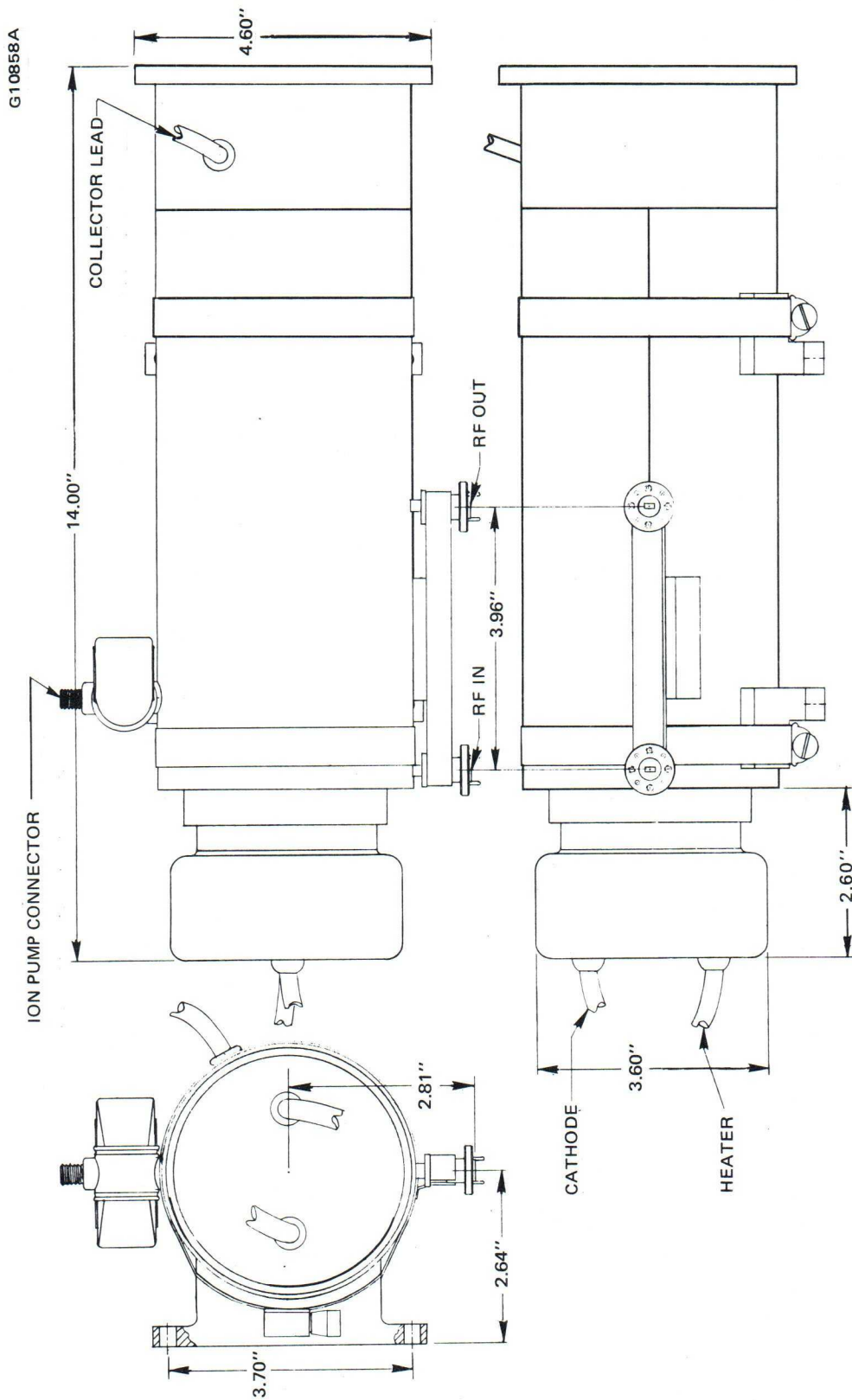

Figure 4-3 960H installation control drawing.

961H V-Band TWT

The 961H is a high-power coupled-cavity TWT that is being developed for a space communication system at V-band. The tube employs an M-type cathode operating at 2.0 A/cm^2 . The tube produces 75 watts over a 3.0 GHz bandwidth. The 961H is PPM focused and uses a four-stage depressed collector for an overall efficiency of greater than 30 percent. The multistage collector will be cooled by direct radiation to space and the tube body will be cooled by conduction to a baseplate.

The operating characteristics of the 961H are listed in Table 4-2. Power output performance versus frequency is shown in Figure 4-4. A photograph of the 961H TWT is shown in Figure 4-5. The installation control drawing for the space tube is shown in Figure 4-6.

TABLE 4-2
OPERATING CHARACTERISTICS OF THE 961H TWT

<u>RF Characteristics</u>	
Frequency	65 GHz
Power Output	75 watts
Gain	50 dB
Duty	CW
<u>Electrical Characteristics</u>	
Cathode Voltage	-19.6 kV
Cathode Current	0.07 A
Multiple Stage Collector	4 stages
Body Current	0.002 A
Heater Voltage	5.0 V
Heater Current	1.0 A

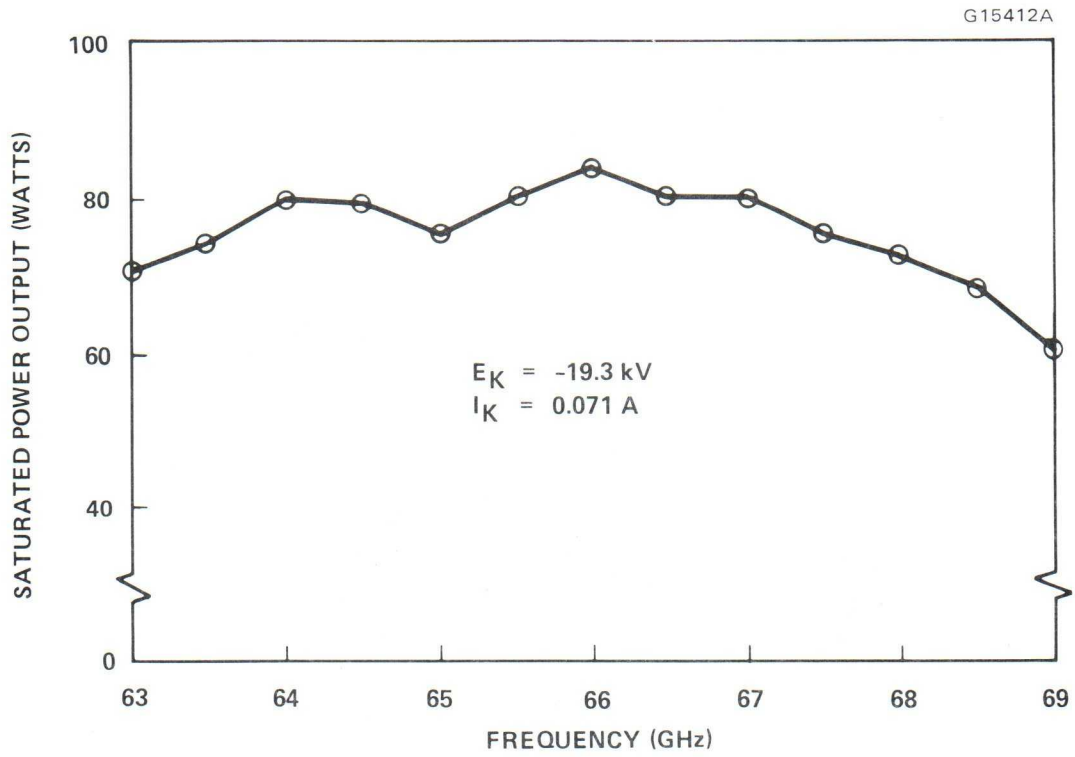

Figure 4-4 961H RF power output vs frequency.

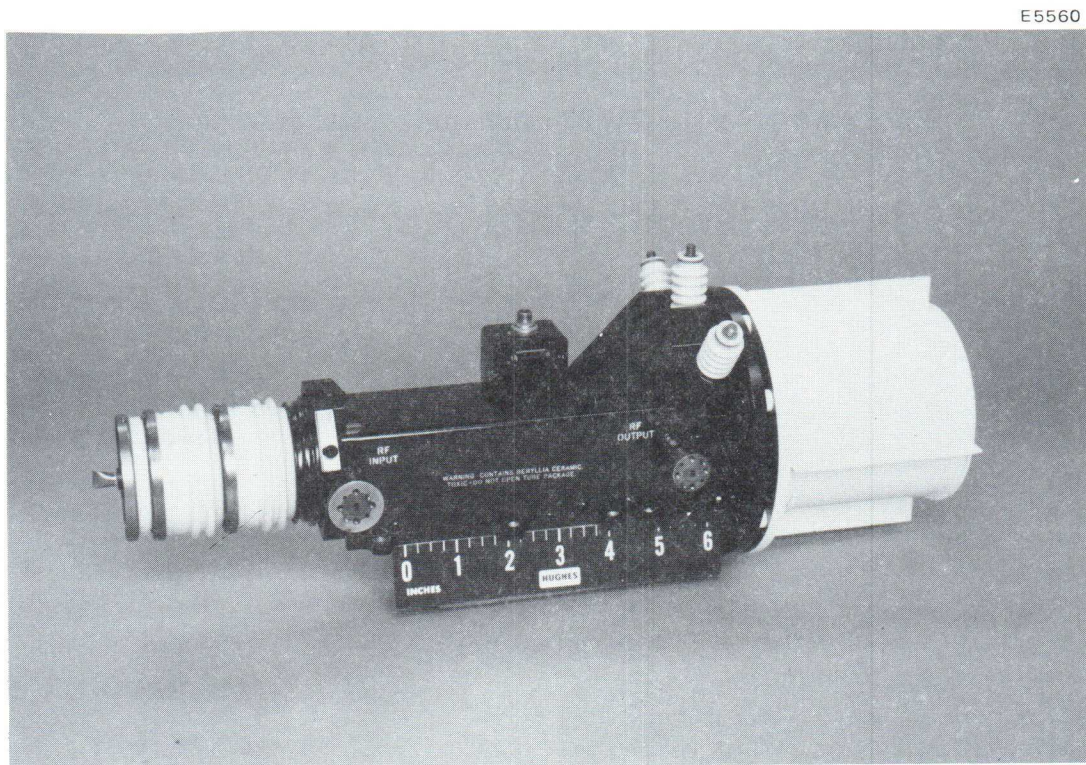

Figure 4-5 Photograph of conduction cooled body/radiation cooled collector 961H TWT.

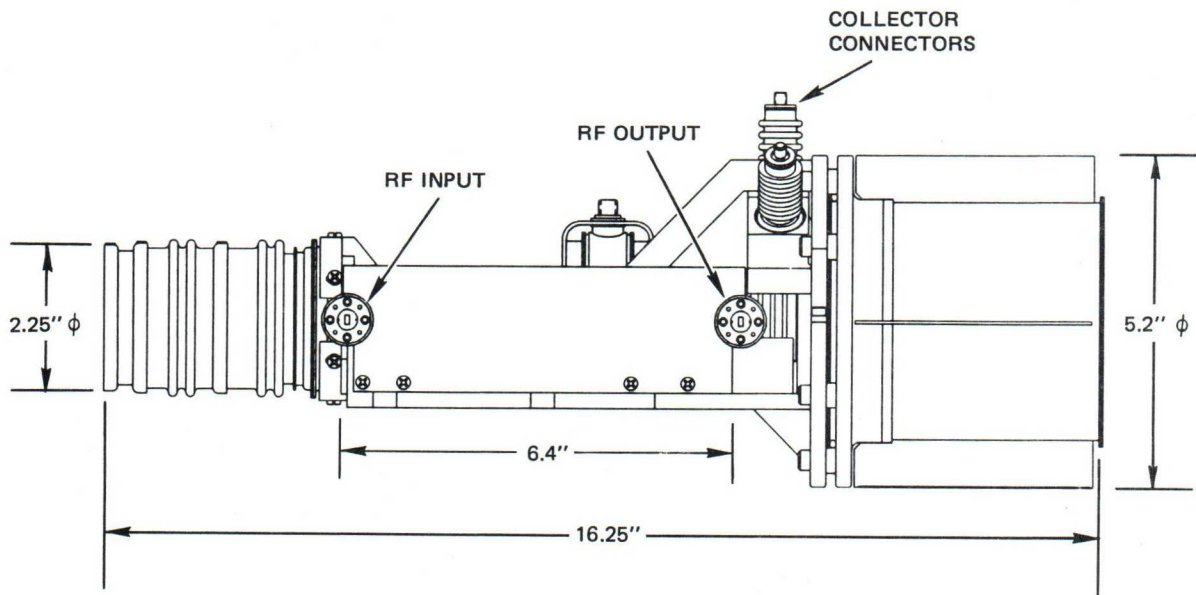

Figure 4-6 961H TWT installation control drawing.

5.0 W-BAND TWTS

982H W-Band TWT

The 982H is an 80 watt, 50 percent duty, 94 GHz TWT. The tube is designed for PPM focusing and broad bandwidth. Modulation is provided by an aperture grid, and the tube uses a single-stage depressed collector. To increase the thermal ruggedness of the coupled-cavity circuit, a beam scraper is incorporated. Both liquid- and air-cooled versions of the 982H TWT are available.

The operating characteristics of the 982H TWT are listed in Table 5-1. RF power output versus frequency is shown in Figure 5-1. A liquid cooled 982H TWT is shown in Figure 5-2. An installation control drawing is shown in Figure 5-3.

TABLE 5-1
OPERATING CHARACTERISTICS OF THE 982H

<u>RF Characteristics</u>	
Frequency	92.75 to 94.75 GHz
Power Output	80 watts
Gain	50 dB
Duty	50 percent
<u>Electrical Characteristics</u>	
Cathode Voltage	-21 kV
Cathode Current	0.091 A
Collector Voltage	-10 kV
Body Current	0.008 A
Grid Pulse Voltage	1.0 kV
Grid Bias Voltage	-300 V
Filament Voltage	5.0 V
Filament Current	1.0 A

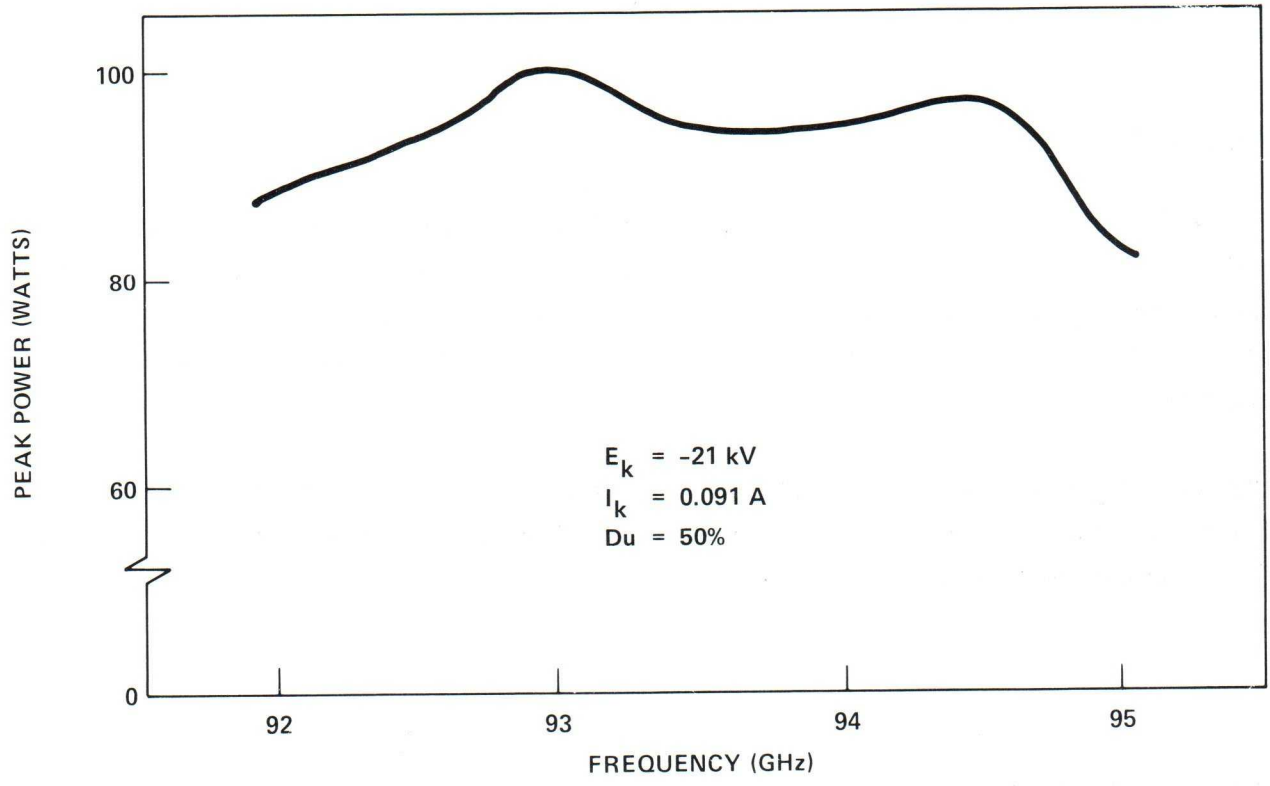

Figure 5-1 982H RF power output vs frequency.

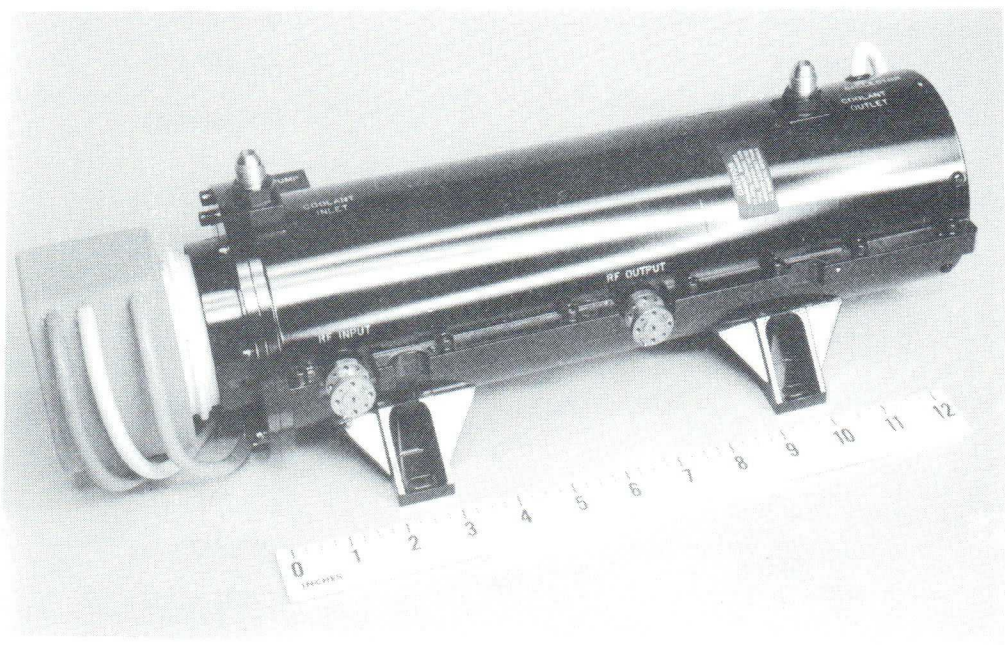

Figure 5-2 Photograph of 982H TW1.

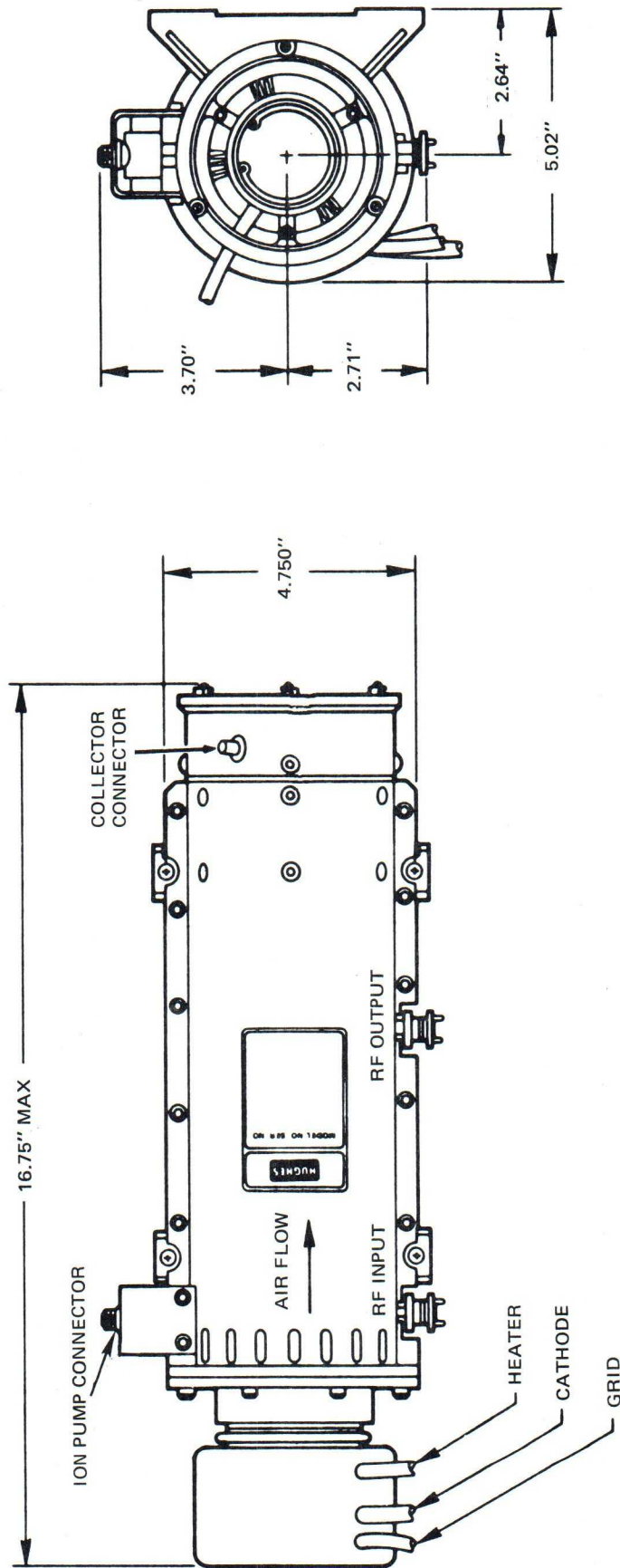

Figure 5-3 Air cooled 982H installation control drawing.

980H W-Band TWT

The 980H is a dielectric oil-cooled coupled-cavity TWT providing 1.0 kW of peak power at 10 percent duty cycle over the 93.25 to 94.75 GHz frequency range. This high power tube is solenoid focused, employs an aperture grid for beam modulation, and uses a single-stage depressed collector. A summary of the tube's operating characteristics is given in Table 5-2. A plot of saturated power output versus frequency is shown in Figure 5-4. A photograph of 980H is shown in Figure 5-5. An installation control drawing is shown in Figure 5-6.

TABLE 5-2
OPERATING CHARACTERISTICS OF THE 980H

<u>RF Characteristics</u>	
Frequency	93.25 to 94.25 GHz
Power Output	1.0 kW
Gain	50 dB
Duty	10%
<u>Electrical Characteristics</u>	
Cathode Voltage	-39 kV
Cathode Current	0.390 A
Collector Voltage	-27 kV
Collector Current	0.386 A
Body Current	0.004 A
Grid Voltage	1.7 kV
Grid Bias	-1.0 kV
Solenoid Voltage	160 V
Solenoid Current	23 A

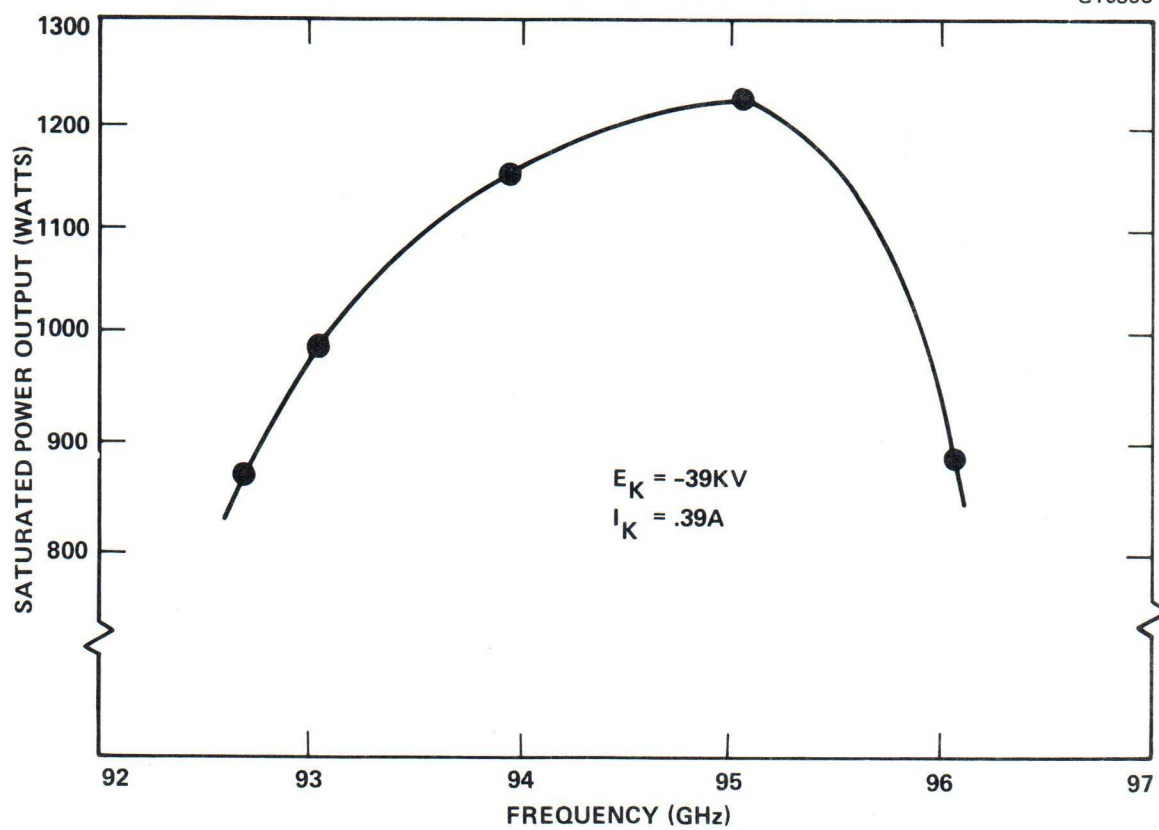

Figure 5-4 980H saturated power output vs frequency.

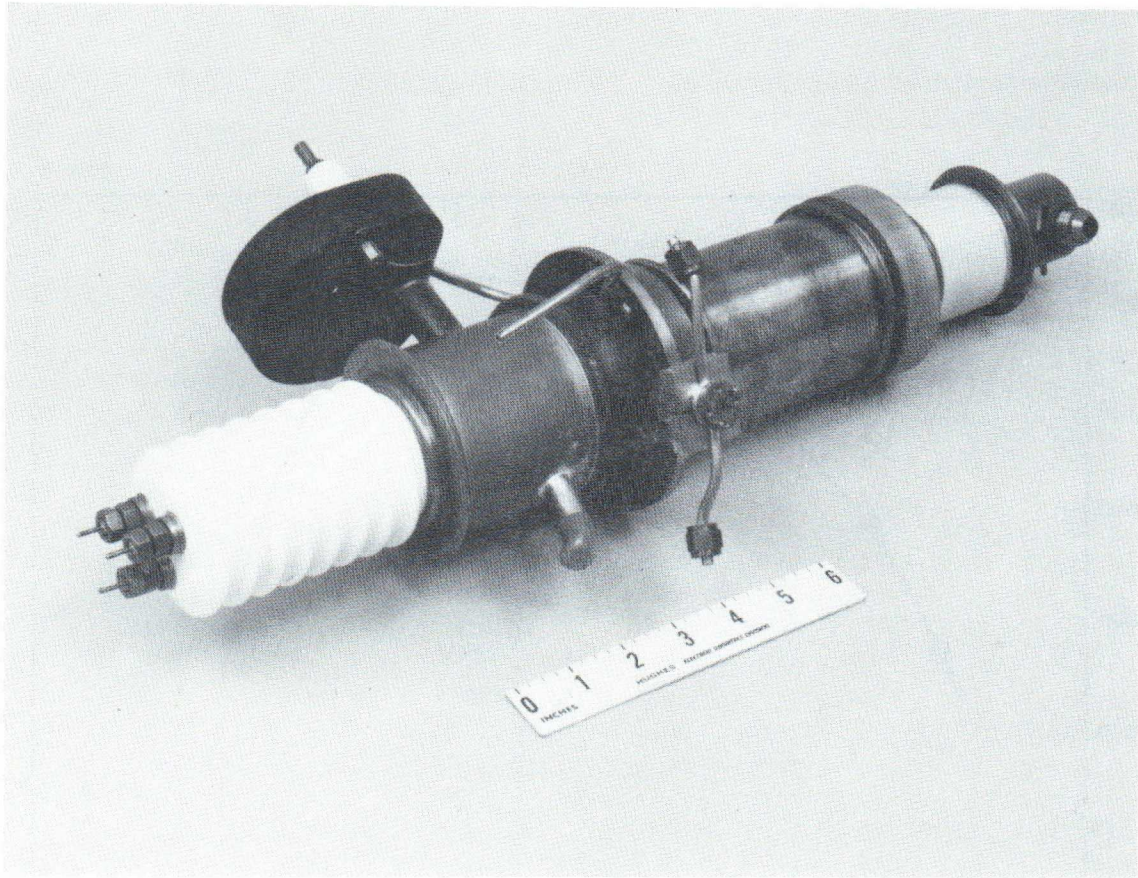

Figure 5-5 Photograph of 980H TWT without solenoid.

G10861A

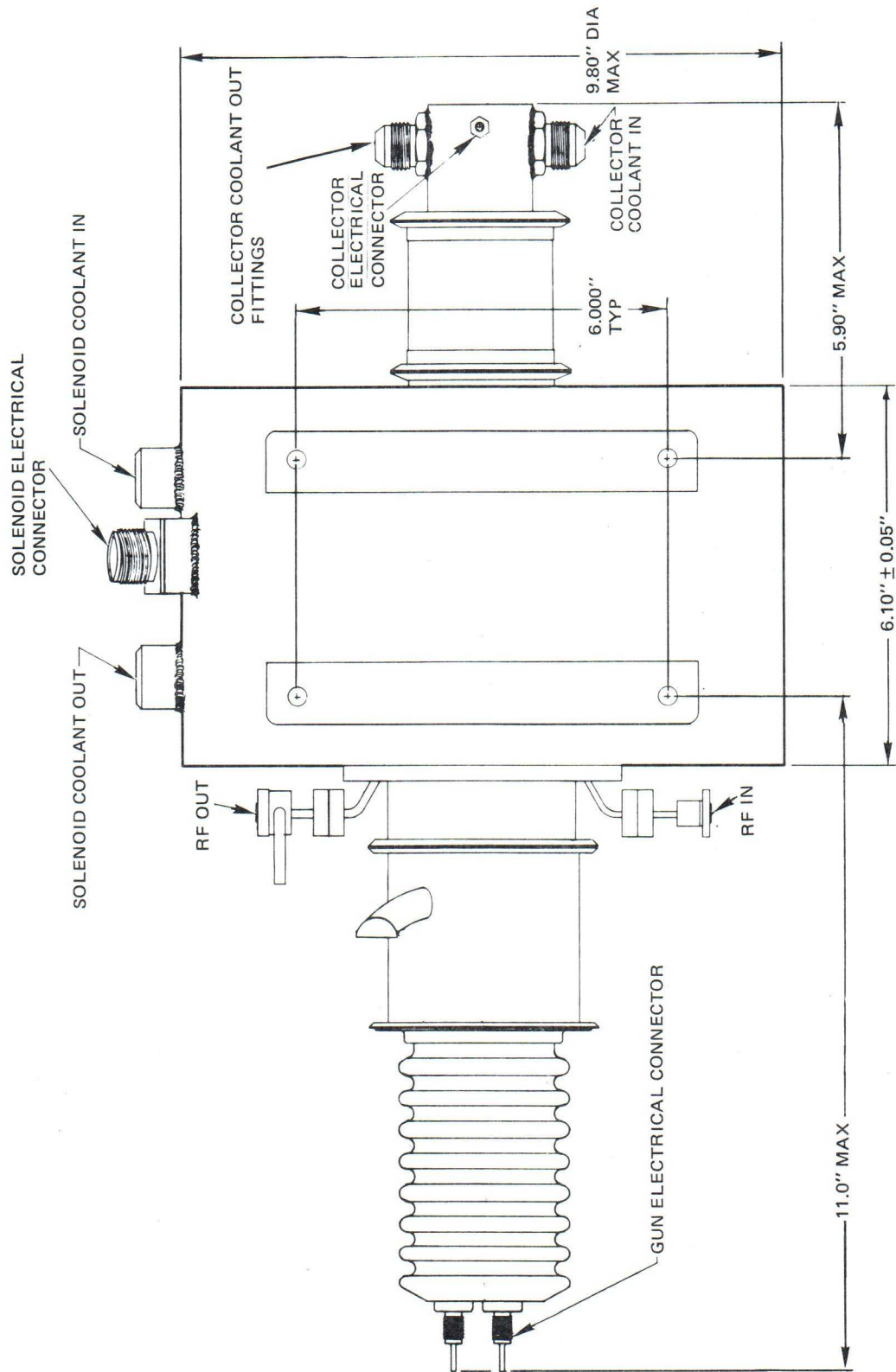
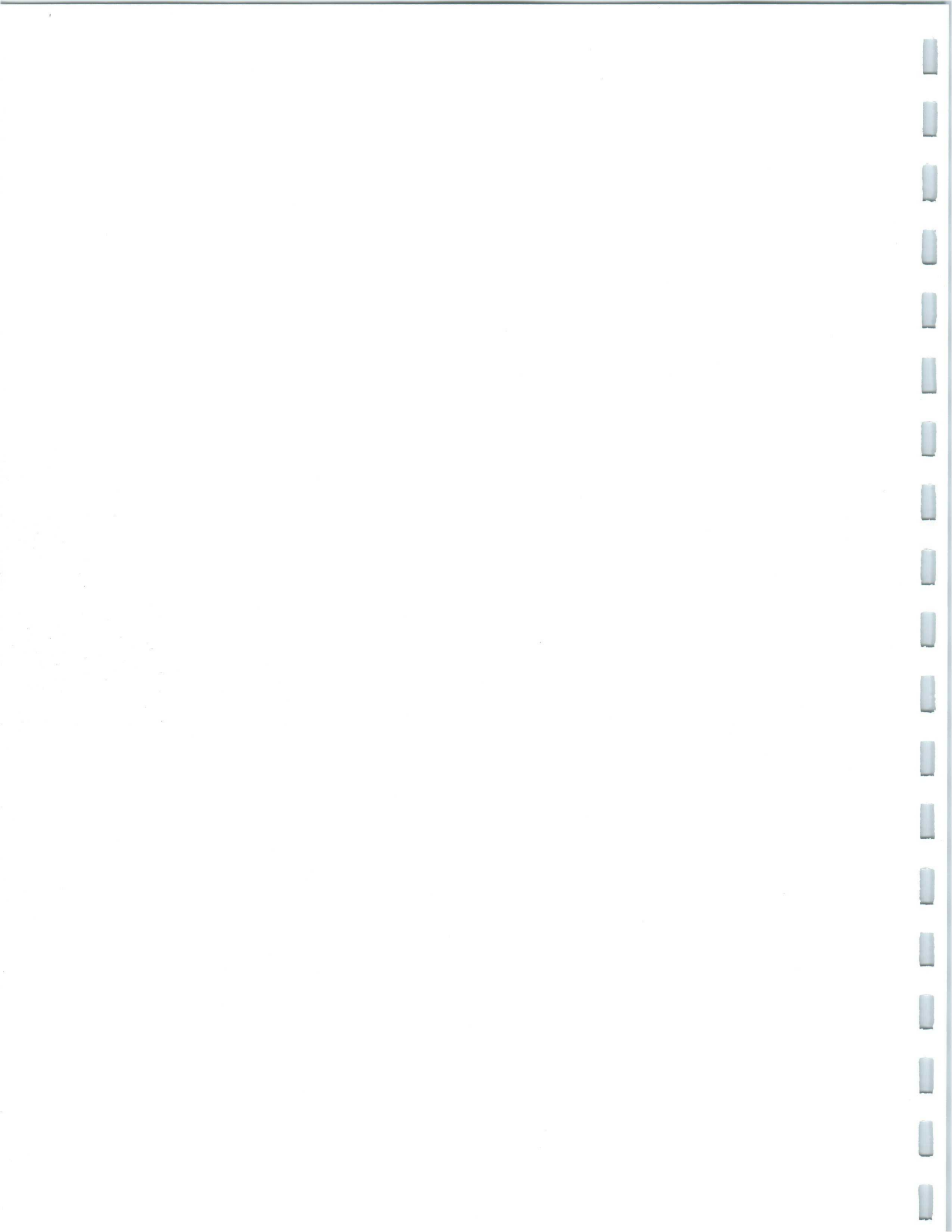

Figure 5-6 980H installation control drawing.



MILLIMETER-WAVES

Rectangular Waveguide Specifications

RIGID RECTANGULAR WAVEGUIDES											
Letter Designation	EIA WG Designation	JAN WG Designation	Recommended Operating Range for TE ₁₀ Mode		Cut-Off for TE ₁₀ Mode		Standard Atmospheric Conditions CW Breakdown Power (KW)	Flange Specifications		Inside Dimensions Inches (mm)	Nominal Wall Thickness Inches (mm)
			Frequency (GHz)	Wavelength (mm) (free space)	Frequency (GHz)	Wavelength (mm)		MIL-F-3922/XX-XXX	UG-XXX/U Equivalent		
K	WR 42	RG 53/U	18.0-26.5	16.6-11.3	14.047	21.34	160-240	54-001	UG-595/U	.420 x .170 (10.7 x 4.32)	.040 (1.02)
Ka	WR 28	RG 96/U	26.5-40.0	11.3-7.5	21.081	14.22	95-145	54-003 67B-005	UG-599/U UG-381/U	.280 x .140 (7.11 x 3.56)	.040 (1.02)
Q	WR 22	RG 97/U	33.0-50.0	9.1-6.0	26.342	11.38	62-90	67B-006	UG-383/U	.224 x .112 (5.69 x 2.84)	.040 (1.02)
U	WR 19		40.0-60.0	7.5-5.0	31.357	9.56	47-64	67B-007	UG-383/U Mod	.188 x .094 (4.78 x 2.39)	.040 (1.02)
V	WR 15	RG 98/U	50.0-75.0	6.0-4.0	39.863	7.52	29-42	67B-008	UG-385/U	.148 x .074 (3.76 x 1.88)	.040 (1.02)
E	WR 12	RG 99/U	60.0-90.0	5.0-3.3	48.350	6.20	20-29	67B-009	UG-387/U	.122 x .061 (3.10 x 1.55)	.040 (1.02)
W	WR 10		75.0-110.0	4.0-2.7	59.010	5.08	14-20	67B-010	UG-387/U Mod	.100 x .050 (2.54 x 1.27)	.040 (1.02)
F	WR 8	RG 138/U	90.0-140.0	3.3-2.1	73.764	4.06	8.5-13.5	74-001*	UG-387/U* Mod	.080 x .040 (2.03 x 1.02)	.030 (0.86)
D	WR 7	RG 136/U	110.0-170.0	2.7-1.8	90.786	3.30	5.8-9.0	74-002*	UG-387/U* Mod	.065 x .0325 (1.65 x 0.83)	.030 (0.86)
G	WR 5	RG 135/U	140.0-220.0	2.1-1.4	115.71	2.59	3.7-6.1	74-003*	UG-387/U* Mod	.051 x .0255 (1.30 x 0.65)	.030 (0.86)

*MIL-F-3922/74-001, 002, & 003 are pin contact flanges not equivalent to the UG-387/U Mod round flange.

Atmospheric Attenuation

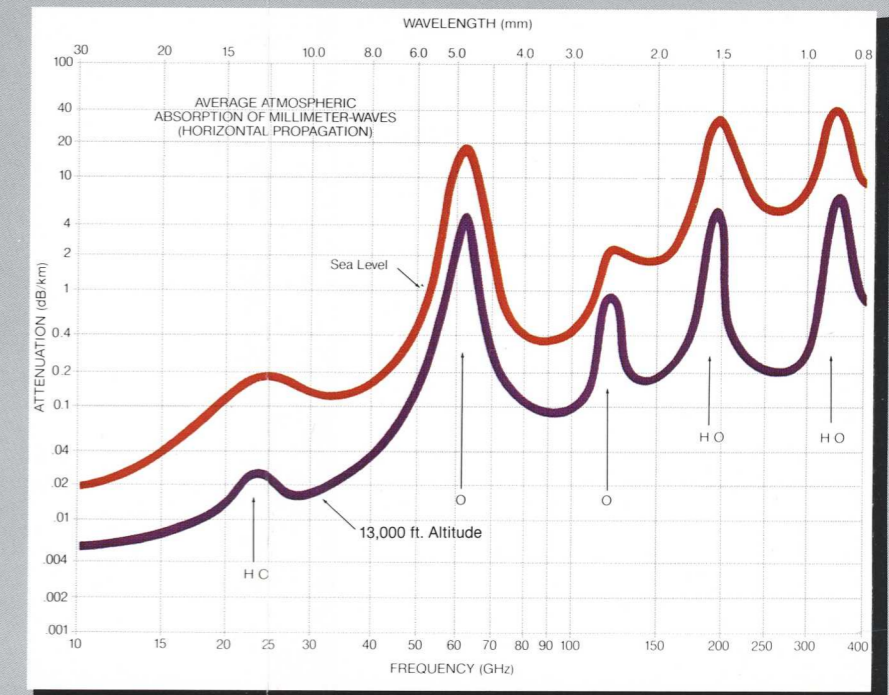
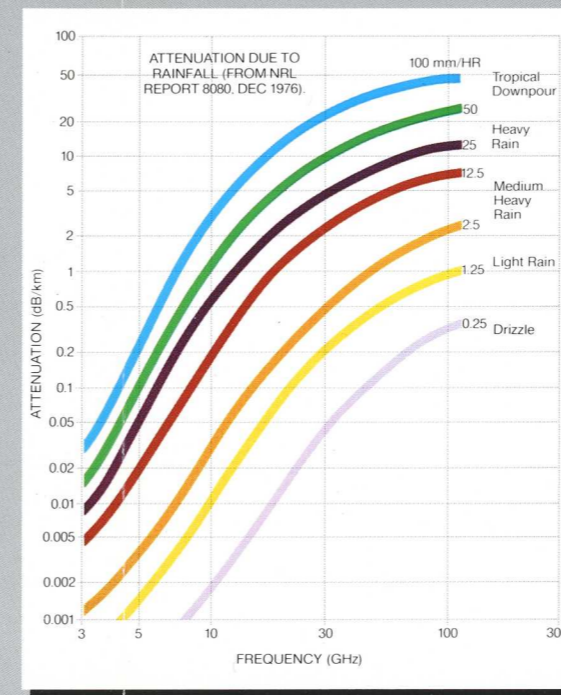

Waveguide Attenuation

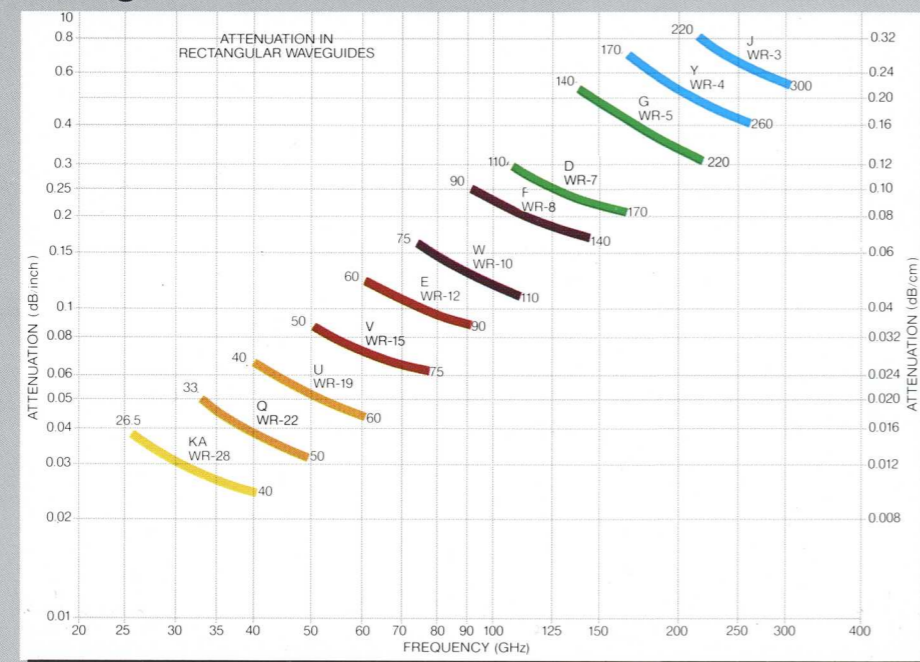

Rainfall Distribution

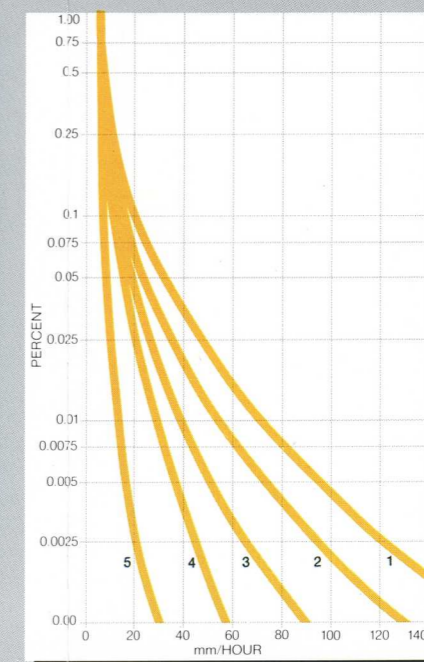
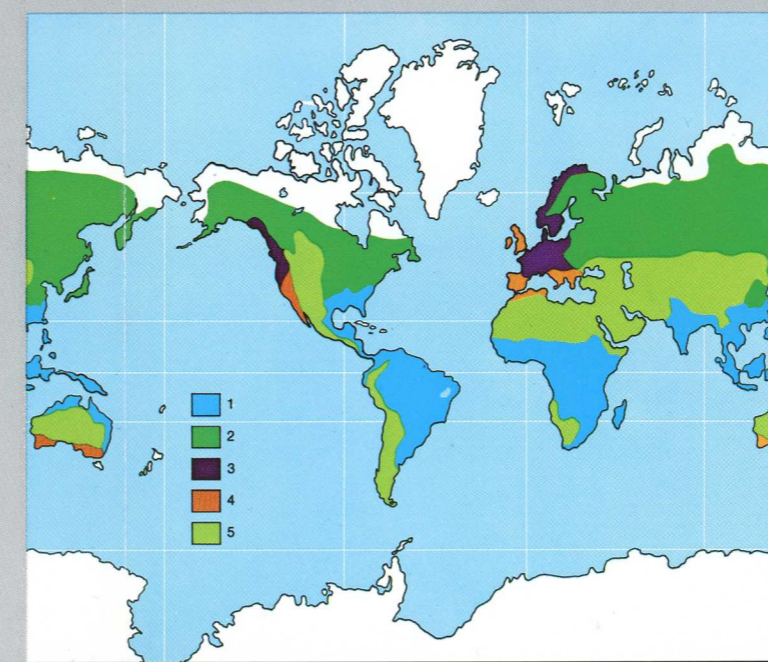

BOTTOM CENTER: Worldwide Distribution of Rainfall. The 5 rainfall areas vary from the heavy rain in tropical areas (Area 1) to desert areas (Area 5) (from CCIR, Volume V, 1974).

BOTTOM RIGHT: Rates of Rainfall for the Five Rain Climates. The percentage of an average year for which the rainfall rate is exceeded for the five rain climates (from CCIR, Volume V, 1974).

Hughes Electron Dynamics Division
P.O. Box 2999
Torrance, CA 90509
213/517-6174

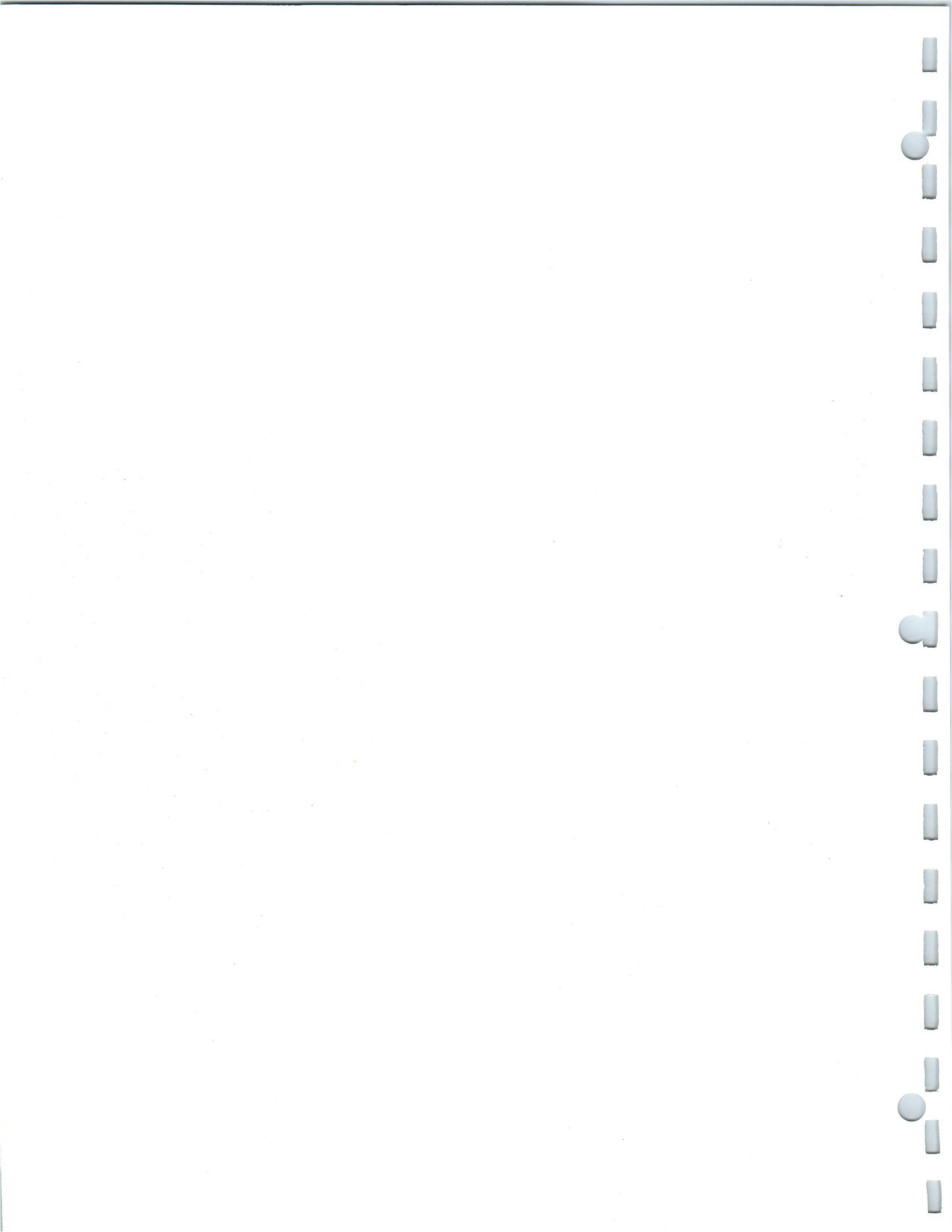

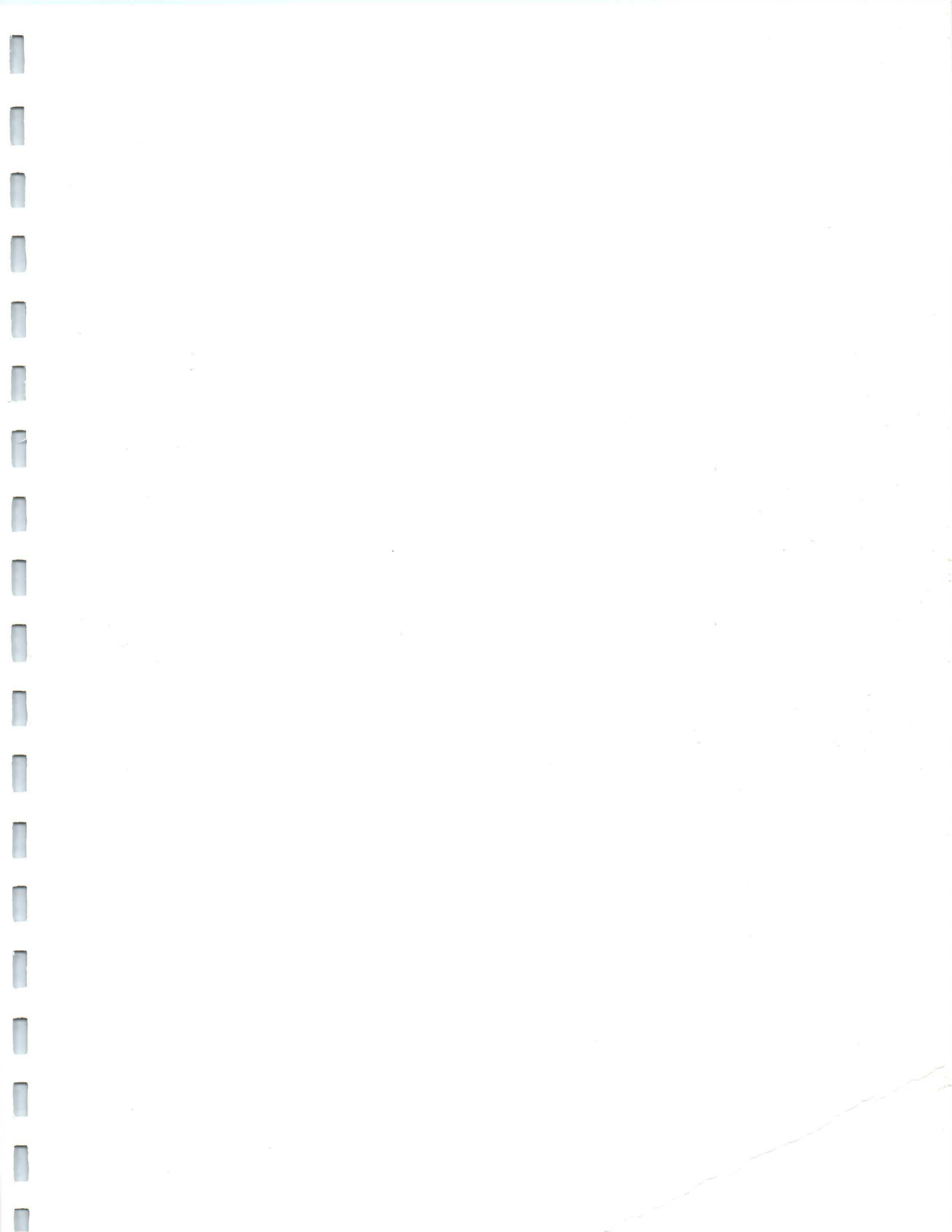



ELECTRON DYNAMICS DIVISION
Industrial Electronics Group

3100 West Lomita Boulevard
P.O. Box 2999, Torrance, CA 90509-2999
Telephone: (213) 517-6176
TWX 910 347 7321 HACEDYN TRNC