



*Storage*

# PHILIPS

## test and measuring notes



1972/1



# PHILIPS

## test and measuring notes

### Introduction

The periodical *Test and Measuring Notes* provides information about the application and design of Philips electronic measuring and microwave instruments, and also surveys the new instruments which are regularly added to the Philips programme.

The information is intended to assist users in getting the maximum benefit out of instruments which they already possess and to help them in choosing new instruments which will best meet their particular measuring or microwave needs.

### The front cover

of this issue shows the set-up of the new storage oscilloscope PM 3251 used for checking Philips electrocardiogram equipment

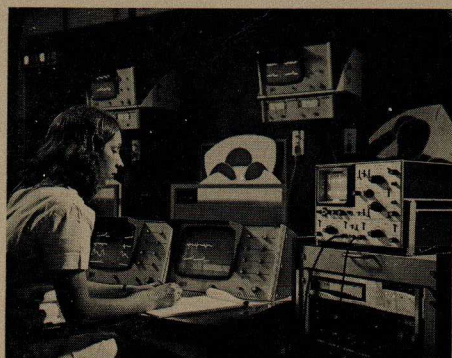

### In this issue

PM 3251, a 50 MHz storage oscilloscope with variable persistence and storage

New Philips half-tone storage CRT combined with exceptional bandwidth-sensitivity product of the existing PM 3250 general-purpose oscilloscope

The PM 6640 frequency counter

This instrument gives accurate measurements over a wide frequency range

The Philips Stirling engine

How electronics is used in the testing of the engine

Digital instrument course

Morse a dead art?

New products

Video calibration generator PM 5546

page

1

5

8

12

13

14

### General information

If you are interested in regularly receiving the periodical *Test and Measuring Notes* and also in more information about the instruments please ask your Philips organisation. If there is no Philips organisation in your country enquires may be sent to n.v. Philips' Gloeilampenfabrieken, Test and Measuring Instruments Department, Eindhoven, the Netherlands.

### Republication or translation

is permitted if the source of information is mentioned. The issue of the information contained in this publication does not imply any authority of licence for the utilisation of any patented feature.

### Published by

n.v. Philips' Gloeilampenfabrieken, Eindhoven, the Netherlands

### Editor

T. Sudar, n.v. Philips' Gloeilampenfabrieken, Test and Measuring Instruments Department

### Assistant editor

R. H. Bathgate, Cambridge, England

### Layout

Fr. B. van de Vegte, Waalre



# PM 3251, a 50 MHz storage oscilloscope with variable persistence and storage

by A. M. op de Weegh and J. Wouters

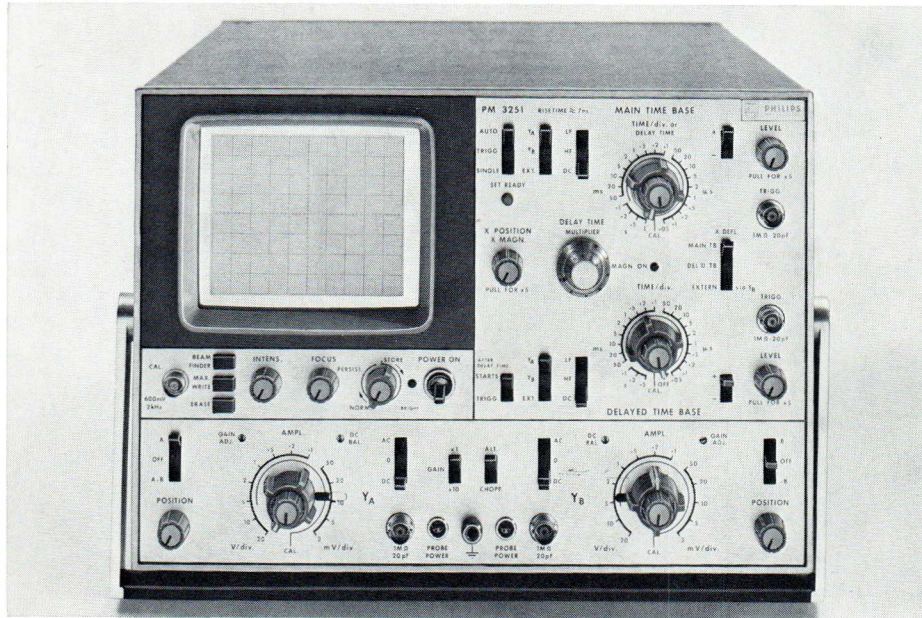

Present oscilloscopes suffer from three important disadvantages:

1. *Observation and study of single-shot events is only possible with photographic aid.*
2. *Low-frequency signals must be viewed on a flickering display, whilst high-frequency signals having a low repetition rate are barely visible because of their low intensity on the screen.*
3. *Mixed applications of low and high bandwidth at high or low sensitivities, especially in combination with storage, necessitate the use of more than one instrument for one job or the purchase of plug-in solutions.*

The disadvantages mentioned above are avoided with the new Philips PM 3251, a dual-trace 50 MHz storage oscilloscope featuring variable persistence and variable storage in addition to the normal mode of the instrument.

The storage mode of the PM 3251 can be used to store single-shot events for later viewing or easy photographing. Comparison of waveforms can be accomplished by storing them separately, and later, viewing them simultaneously. Storage time can be continuously adjusted up to a maximum which is in excess of two hours. The storage control serves also for adjustment of trace brightness, an increase in brightness being accompanied by a reduction in storage time.

The variable persistence capability is especially useful when viewing signals having low repetition rates. Adjustment of persistence time can permit viewing of a complete trace, with fade-away just sufficient to prevent interference. The display persistence can be readily adjusted to eliminate flicker without losing high resolution. Without using additional knobs the variable persistence mode can be used also to 'fill out' HF signals having low repetition rates, the signal being built up in the oscilloscope memory until a clear picture is obtained.

The new Philips storage and variable persistence oscilloscope PM 3251 combines the excellent characteristics of the new Philips half-tone storage tube L14-110 GH with the HF dual trace and double time-base facilities of the easy-to-operate general-purpose 50 MHz portable PM 3250 oscilloscope

The dual-bandwidth approach of the PM 3251 permits this compact instrument to be employed as a low-frequency high-input sensitivity ( $200 \mu\text{V}/\text{cm}$  at 5 MHz) instrument for applications such as are found in physics and medical work, audio modulation, acoustics etc., where previous instruments could only be used with special plug-in units. Where bandwidth is perhaps more important than extremely high input sensitivity, such as in computer development work, telecommunications etc., then the PM 3251 can be used in its  $2 \text{ mV}/\text{cm} - 50 \text{ MHz}$  operating mode simply by the throwing of a switch. And don't be afraid of going higher if required; the instrument will trigger perfectly up to 100 MHz.

## Large screen small-size storage CRT

Fitting a storage CRT in a portable 50 MHz oscilloscope presents both mechanical and electrical problems. The tube had to be small enough to fit into the same space as that occupied by the conventional tube of the PM 3250 oscilloscope whilst at the same time housing all the additional storage elements.

The solution is the new rectangular (14 cm diagonal), flat-faced, direct-view storage tube, type number L 14-110GH; a product of the professional-CRT group of the Philips-Elcoma division. Its large screen provides a useful display area of  $8 \times 10$  divisions and permits careful examination of several traces. This new tube makes possible a considerable increase in writing speed. The isolation between the flood guns and the normal deflection system has been improved. But above all, problems of damage to the storage mesh caused by operating at very high intensities in the normal mode have been virtually eliminated. This is achieved by the improved production methods that are used in the preparation and installation of the mesh.



### Operating a storage oscilloscope

The conventional storage oscilloscope is not often an easy instrument to operate. This, in itself, is a disadvantage; but add to it the fact that misuse can result in permanent damage to the storage tube and the full significance of the problem facing the user becomes apparent.

There are two dangers. One, is that most bi-stable storage tubes age quite rapidly with each storage hour and the user must remember to switch back to 'normal' as soon as possible. The other, is that half-tone storage tubes are known to be over sensitive to very high intensities when used in the normal mode.

The PM 3251 is not a conventional oscilloscope. It has been designed with the avoidance of these problems in mind. The

PM 3251 has only three more controls (a switch and two pushbuttons) than the well-proven PM 3250 on which it is based.

Operational simplicity is inherent, also, in the ergonomic design of the front panel layout. As an additional safeguard, the PM 3251 is fitted with an entirely new Philips storage tube. A tube which virtually eliminates problems of storage mesh damage. It is of the half-tone type and has been designed to be much more operator proof than previous storage tubes. It has, also, the outstanding feature that its operational life is comparable to that of a conventional CRT and is significantly longer than that of most storage tubes employing the bi-stable principle.

layer surface and the number of electrons arriving (secondary emission ratio) plotted as a function of the surface potential. At a potential of about  $V_a$  volts the number of electrons leaving the surface is equal to the number arriving. This point is called the first cross-over (secondary emission ratio = 1).

If the surface is bombarded with electrons of higher energy, the surface potential rises, because more electrons are leaving than arriving.

If the surface is bombarded with electrons with energies lower than at  $V_a$  volts, the surface potential decreases, because fewer electrons are leaving than arriving. A practical value of  $V_a$  for a suitable type of non-conducting material is between +15 and +45 V.

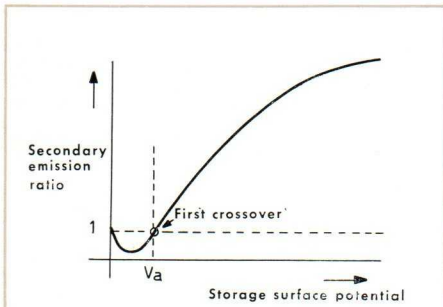

1. Secondary emission ratio

3. Mesh construction used for collector and storage grids

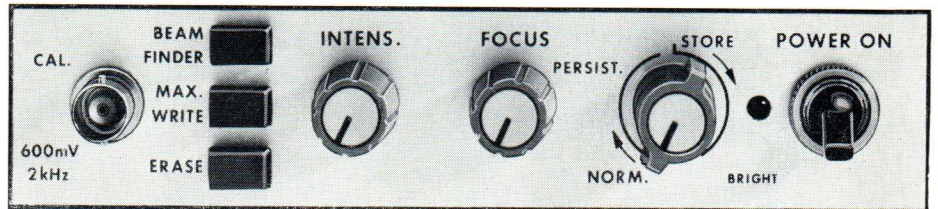
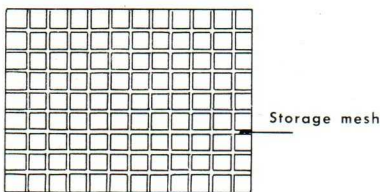

Specific storage controls of PM 3251 limited to one switch and two buttons

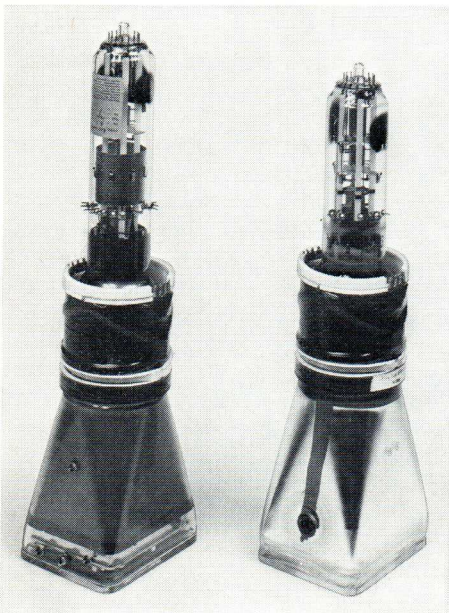
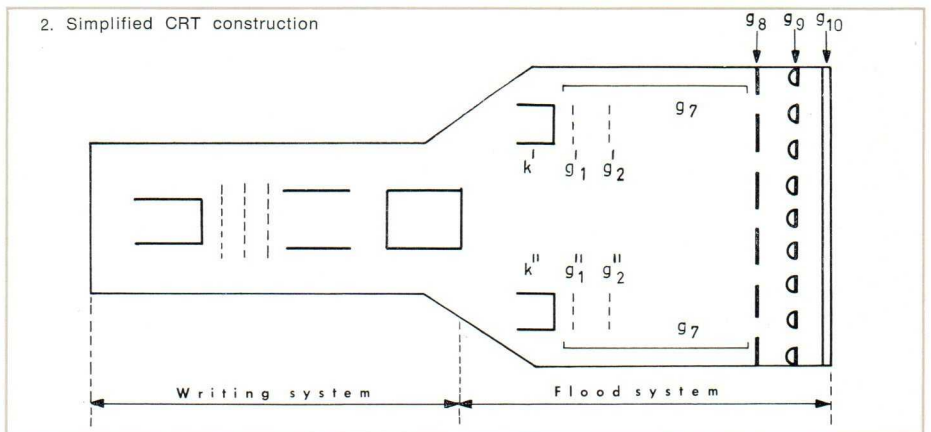

New Philips storage tube L14 - 110 in comparison with standard tube D14 - 160

### Storage principle

The PM 3251 storage oscilloscope contains a storage-mesh the storage time of which can be varied so that it can be used like a normal CRT, but with variable persistence of the displayed signal.

The storage of information takes place by writing the signal information from the normal electron (writing) gun into a storage layer of high quality, non-conductive material, so forming a positive charge pattern by secondary emission of electrons. This charge pattern on the storage surface remains for a considerable length of time, even when the writing gun is switched off. It is made visible on the phosphor viewing screen by a second electron beam the electrons of which are allowed to strike the phosphor via the positively charged positions on the storage layer.

The basis for storage of information on the non-conductive material is the secondary emission ratio curve, as shown in fig. 1. This curve shows the ratio between the number of electrons leaving the storage-

### Storage tube construction and operation

As shown in fig. 2, the PM 3251 storage CRT contains two systems: the 'Writing' system and the 'Flood' system. Construction and operation of the writing part is identical to that of a conventional CRT and will not be dealt with here.

The flood system consists of a pair of flood guns operated in parallel, both having a cathode  $k$ , a control grid  $g_1$  and an accelerator grid  $g_2$ . Common to both flood guns are the flood-beam collimator  $g_7$ , the collector mesh  $g_8$ , the storage mesh  $g_9$  (carrying the storage layer), and the phosphor viewing screen  $g_{10}$ .

The flood guns are physically located just outside the horizontal deflection plates. The cathode potential is at  $-50$  V. A cloud of electrons is emitted by each flood gun cathode. These clouds are combined, shaped, and accelerated by the two control grids  $g_1$  and  $g_2$  and by the collimator  $g_7$  (which is formed by a coating on the inside of the tube). The positive voltage on the collimator is adjusted so that the flood-gun electron cloud just fills



the CRT viewing screen. The cloud is further accelerated towards the storage mesh and viewing screen by the collector mesh  $g_8$ . After passing through the collector mesh, the flood electrons are further controlled by the potentials on the storage mesh and storage-layer surface. Shown in fig. 3 are the storage and collector meshes both with approximately 40  $\mu\text{m}$  apertures. The cathode-side of the storage mesh is coated with a non-conductive material, on which the storage of information takes place, fig. 4a. The capacitive coupling that exists between the storage mesh and the storage-layer surface is essential for the operation of the store and erase functions. The storage mesh rests normally at a potential of approximately +1 V with respect to the

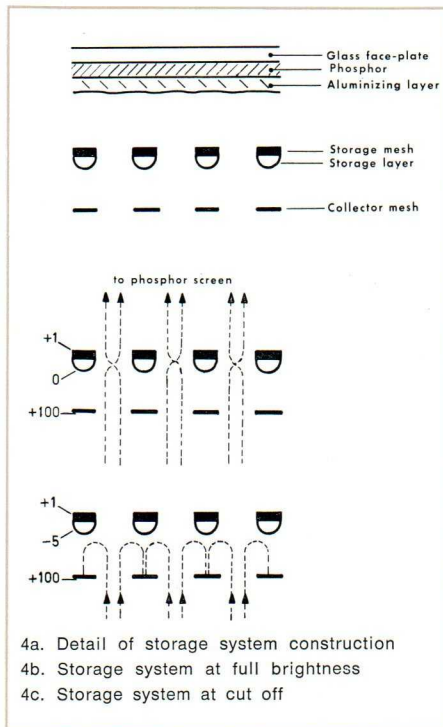

flood gun cathodes. The potential at the storage-layer surface is controlled by Write and Erase routines fed to the storage mesh and varies between 0 V and negative. Fig. 4b shows that when the storage-layer surface is at 0 V, the majority of flood electrons pass through the holes of the mesh and reach the viewing screen. The remaining electrons are repelled by the storage-layer surface and picked up by the collector mesh. When the storage-layer surface is made negative (fig. 4c), the number of electrons passing the storage mesh is reduced considerably. At a certain value (the cut-off level), no electrons are passed. The post-accelerator voltage (approximately 6 kV) is connected to the phosphor viewing screen. As soon as flood electrons are allowed to pass the storage mesh they are accelerated by this high potential and strike the phosphor, thereby causing it to emit light. The storage mesh  $g_9$  (fig. 2) can be compared with the control grid of a triode. Just as the triode grid potential controls

### Technical specifications

The technical specification of the PM 3251 is identical to PM 3250 except for the following:

#### STORAGE CRT

**Type:** New Philips L14-110GH post accelerator half-tone storage tube; 8 kV accelerating potential, P31 phosphor

**Graticule:** 8 x 10 div. internal graticule  
 1 div. = 0.9 cm

#### Persistence:

**Normal:** natural persistence of P31 phosphor (10  $\mu\text{s}$ ... 1 ms)  
**Variable:** continuously variable from < 0.3 s to > 10 min.

**Storage:** Storage time: continuously variable between > 2 hours at minimum brightness to > 10 minutes at maximum brightness

#### Writing speed:

> 100 cm/ms in variable persistence mode  
 > 1.2 cm/ $\mu\text{s}$  in max. write mode

**Erase:** Push button operated. Erasure takes 500 ms approx.

### GENERAL

**Dimensions:** Same as for PM 3250  
**Weight:** 18.5 kg approximately  
**Environmental:** Same as for PM 3250  
**Power requirement:** max. 120 W  
**Voltage and frequency range:** Same as for PM 3250

### Summary of PM 3250 specifications

50 MHz at 2 mV/div  
 5 MHz at 200  $\mu\text{V}/\text{div}$   
 Dual trace with differential possibility  
 Big 8 x 10 cm display  
 Main and delayed time base with calibrated delay time multiplier  
 Complete and independent triggering  
 Full range of accessories

### 5. Persistence and storage basic pulser circuit

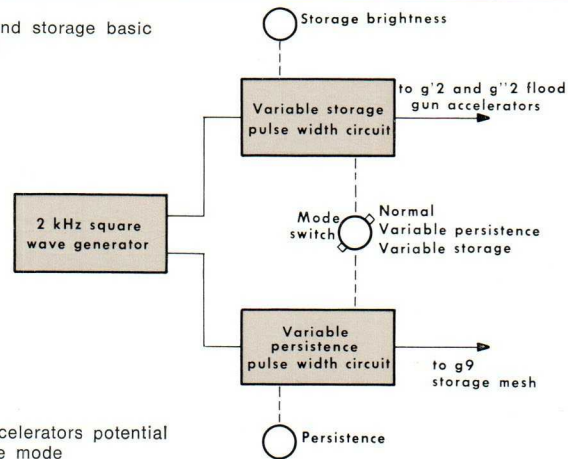

### 6. Flood gun accelerators potential during storage mode

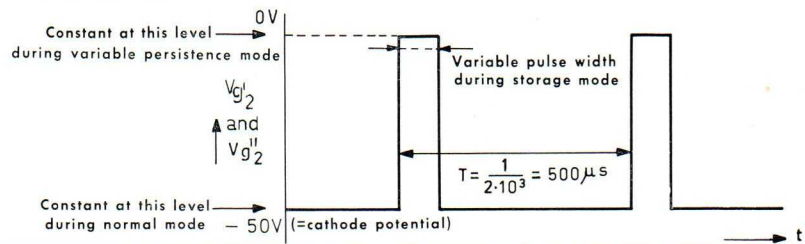

anode current, so the flood storage mesh potential controls the current of flood electrons to the screen and thus the intensity of the trace. An operator control for varying the brightness during storage will be discussed later.

### Writing and storage

Let us assume that the storage-layer surface has been prepared by an Erase routine (to be discussed later) such that it is below the cut-off level: no flood electrons can reach the screen. When we now activate the writing cathode and let the electron beam move over the storage-layer surface, the high potential difference ( $-1500$  V) existing between the cathode and this surface will cause the electrons to arrive at the surface with energy much in excess of first crossover. The surface will be charged in a positive direction wherever the electrons strike. The highest potential that can be reached is 0 V (flood gun cathode potential), any value above this would attract flood electrons, so reducing the surface to its original 0 V po-

tential. We have seen in fig. 4b that those areas of the storage-layer surface that are charged to near zero volts, allow the post-accelerator field to 'reach through' and capture floodgun electrons. Thus, the pattern of charge on the storage-layer surface is made visible on the screen.

The potential of the flood gun accelerators  $g'_{1/2}$  and  $g''_{1/2}$  is controlled by the upper of the pulser circuit shown in fig. 5. Depending on the operator mode selected, the accelerator grids are either continuously at cathode potential (Normal mode), continuously at +50 V (variable persistence mode) or pulsed positively at variable width (variable storage mode); see fig. 6. The storage brightness has a linear relationship with the pulse width selected. When the mode control is set to minimum brightness, the pulse will be almost cut off, and storage time will be maximum.



## Erasure

Erasure of stored information can be done in two ways: by the Manual-Erase function or, in the variable persistence mode, by the Auto-Erase function.

### Manual Erase

In the manual-erase mode the potential at the storage mesh is varied in accordance with the curve of fig. 7a. The corresponding curve for the storage-layer surface potential is shown in fig. 7b.

When the ERASE button is pressed (and held)  $t_1$ , the storage mesh is changed to the same potential as the collector mesh (+100 V). The storage-layer surface follows to almost the same potential by capacitive coupling. Since this surface is then being bombarded by electrons with energies

much higher than that at first crossover the entire surface potential becomes strongly positive and all information in the storage layer is overruled.

The surface potential cannot increase much beyond +100 V because the collector mesh would then repel the emitted electrons back to the storage surface, tending to decrease its potential.

When the ERASE button is released,  $t_2$ , the storage mesh returns to +1 V and the storage-layer surface follows to the same potential by capacitive coupling but then decays to zero volts by the action of the flood-gun electrons.

After 200 milliseconds,  $t_3$ , the storage mesh is automatically raised to +11 V. It is held there for 400 milliseconds. The storage-layer surface follows to +10 V by

capacitive coupling but immediately starts decaying towards zero volts by capturing flood-gun electrons.

At the end of the 400 milliseconds,  $t_4$ , the storage mesh is brought back to +1 V. This reduces the storage-layer surface from zero volts to -10 V. The erasure cycle is now complete, and the system is ready for the input of new information.

### Auto Erase

In the auto-erase mode, recovery of the storage-layer surface potential to below cut-off level is accomplished after a number of automatic cycles of pulsed erasure. This is done by connecting a 2 kHz square-wave signal from the pulser circuit of fig. 5 to the storage mesh  $g_2$ . This signal, and the corresponding potential at the storage-layer surface, are shown in figs. 8a and 8b. As in the manual-erase cycle, the storage-layer surface potential follows the voltage changes on the mesh. However, during each pulse the surface is moved positive and attracts and captures flood-gun electrons, tending to lower the potential by an amount  $\Delta V$ . If this procedure is repeated many times the rest potential at the storage-layer surface will eventually pass the cut-off level and the stored trace will be erased.

When the pulse width is increased as shown in fig. 8c the drop in surface potential is increased also ( $\Delta V'$ ) and fewer cycles of the square-wave are needed to complete the erasure.

Varying the pulse width is accomplished by means of the variable persistence control (PERSIST.) of the PM 3251. Persistence can be adjusted between 0.3 sec and 10 minutes.

### Maximum write mode

The secondary emission of electrons from the storage-layer surface caused by the bombarding flood-gun electrons, must charge the surface from its erased potential of -10 V to the storage threshold (cut-off level) of about -5 V before flood electrons can be captured by the post-accelerator (fig. 7b). Thus, the writing speed of the CRT can be enhanced by erasing the surface to just below this writing threshold. By pressing the button "Max. Write" the amplitude of the erase pulse, shown in fig. 7a during  $t_3 - t_4$ , is reduced by approximately half. This results in a rest level after erasure of around -5 V. As the storage surface potential is raised to near the threshold potential, a part of the electron cloud is permitted to pass on to the screen, resulting in a light green background illumination. Although the contrast ratio is reduced, the writing speed for fast single-shot signals is increased between 10 and 20 times.

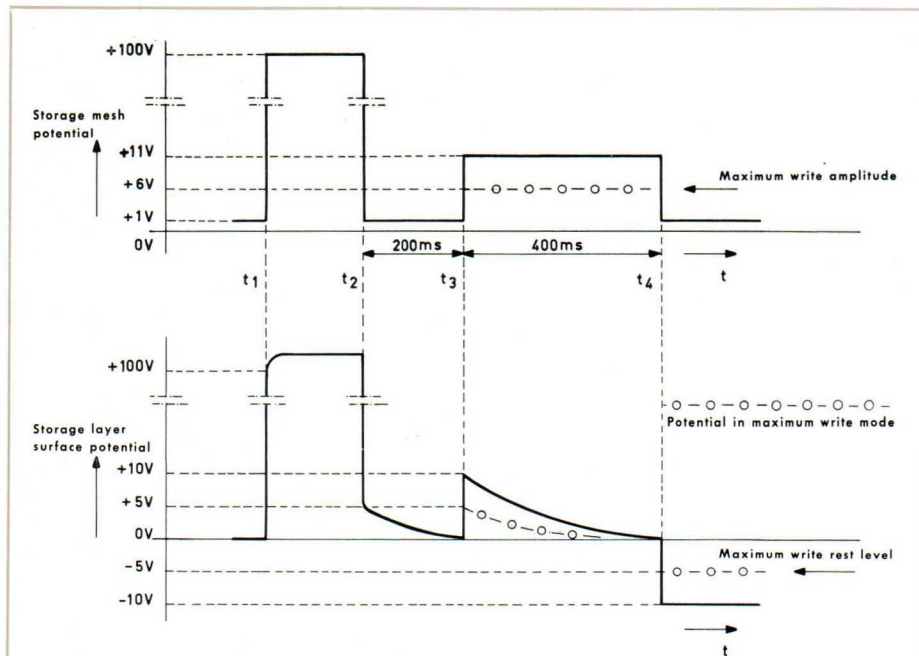

7a. Storage-mesh potential during erase cycle

7b. Storage-layer surface potential during erase cycle

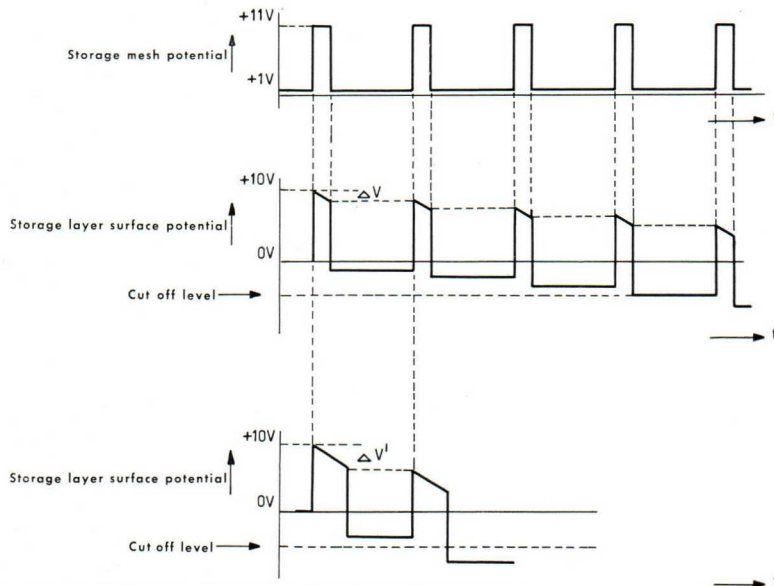

8a. Storage-mesh potential during variable persistence mode

8b. Corresponding storage-layer surface potential containing information

8c. Same as 8b but persistence adjustment shorter (bigger pulse width)



# The PM 6640 frequency counter

by B. Magnusson, Philips Industrielektronik Solna, Sweden

A brief description of the front panel layout is followed by a technical description of the instrument. Particular emphasis is placed on the automatic gain-controlled circuit which enables high input sensitivity and good noise suppression to be attained. Information on plug-ins is also given.



In the field of electronic engineering, and in particular of telecommunications, progress is becoming more and more dependent on the availability of highly sophisticated measuring instruments giving accurate measurements over a wide frequency range, even at low signal levels and low signal-to-noise ratios. The Philips PM 6640 frequency counter has been specially designed to meet such requirements. It has been found that the majority of users in telecommunications make frequency measurements but not time measurements; it is thus cheaper and simpler for them to acquire a "frequency only" meter like the PM 6640 than a counter/timer.

Like its counter/timer cousin PM 6630 (see these Notes, 1969/2), the PM 6640 forms the basic unit of a counter system. A wide choice of internal and external plug-ins extends the useful range of the basic unit. These will be discussed below, after a general description of the PM 6640 and details of the input AGC and the mechanical design of the frequency counter.

## General description

The PM 6640 frequency counter gives a direct count of frequencies from 30 Hz to 225 MHz with a 10 mV input sensitivity over the entire frequency range. The reading is normally given as a 9-digit decimal display, but a plug-in unit permits BCD

output too. (This 9-digit display allows the frequency of e.g. a 200 MHz signal to be displayed down to the last Hertz.) A unit annunciator to the right of the display indicates the unit of measurement used. The input impedance can be chosen as 50  $\Omega$  or 1 M $\Omega$ ; the input circuit also features automatic gain control, giving a wide dynamic range (10 mV to 5 V) and good noise suppression.

The desired measuring mode is selected by means of push-buttons. When the FREQUENCY button is depressed, a direct display of the frequency is obtained. When the RATIO button is depressed, on the other hand, the counter displays the frequency ratio between the signal applied to the front-panel input and a second signal applied to an input at the rear of the instrument. No further adjustment of the controls is required on changing over from frequency to ratio display.

The gate time can be set to four values from 10 milliseconds to 10 seconds. A quick test of the counter's function is provided by the CHECK button. When this is depressed, the internal 10 MHz time base is counted and displayed.

A green GO lamp indicates that the input signal level is high enough for accurate counting.

An input at the rear of the instruments accepts external reference frequencies of 10 MHz, 1 MHz or 100 kHz; the frequency in question can be chosen with a selector switch situated inside the instrument. The internal 10 MHz standard signal can also be taken out from a terminal at the rear of the PM 6640.

The fastest decade of the PM 6640 makes use of a tailor-made hybrid thin-film circuit containing a complete quinary divider. The result is a tiny dual-in-line package which occupies less space and is much more reliable than the comparable transistorized circuits. It goes without saying that the remaining digital sections are designed with TTL IC's of standard or high-speed types.

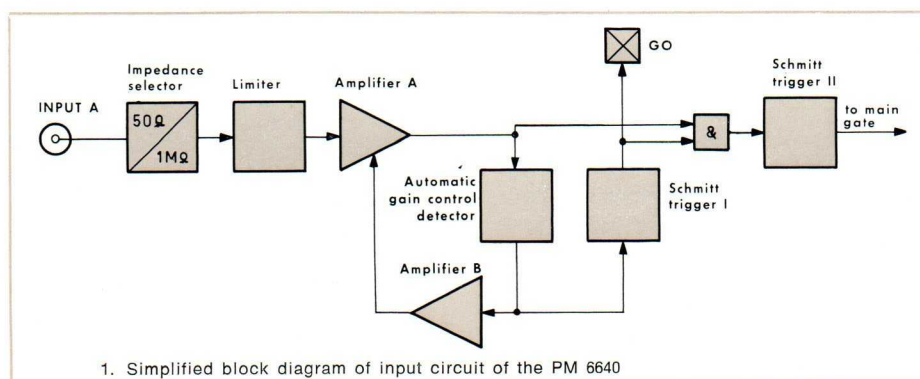

1. Simplified block diagram of input circuit of the PM 6640



range extends from 10 mV to 5 V, and no manual adjustment is required.

Figure 1 shows a simplified block diagram of the input circuit.

From INPUT A the signal passes through the impedance selector and a limiter to amplifier A. If the input signal level exceeds about 10 mV<sub>rms</sub>, a portion of the output signal from amplifier A is detected by the AGC detector. This detected signal switches Schmitt trigger 1 so that the GO lamp turns on and AND gate is enabled. Now the signal from amplifier A can pass through this gate to Schmitt trigger 2, which produces the counting signal led to the main gate of the counter.

The output of the AGC detector is also connected to amplifier B. If the signal level exceeds about 15 mV, this amplifier produces an AGC signal which is passed to the input of amplifier A. The gain of amplifier A will thus decrease proportionately to the magnitude of this control signal. In this way, the output level of amplifier A is kept constant no matter how the input amplitude varies. The delayed action of the AGC also permits AM signals with a modulation depth of up to 30% to be measured.

The constant output amplitude of amplifier A also helps to suppress spurious count pulses due to noise.

This is illustrated in figures 2 and 3. Fig. 2 shows a situation that could occur with a counter having a conventional input circuit without AGC. A sine wave with a superimposed noise (here represented by a single needle pulse) will cause counting errors because the noise extends beyond the trigger window.

The AGC circuit of the PM 6640 gets round this trouble as shown in fig. 3. The same input signal with noise is now automatically amplified less, so as just to fit the trigger window. The noise component now remains within the trigger window so no additional triggering occurs and the user is not misled by a false display.

This makes the AGC method superior to the conventional attenuator controlled input circuits. All signal components are reduced by the same factor which means that the signal-to-noise ratio is kept constant.

#### Mechanical design

The design of the PM 6640 represents an optimum compromise between ruggedness and good serviceability. The main features of the mechanical design are shown in the exploded view of fig. 4.

The printed-circuit cards are plugged into connectors on a large mother board which also contains the time-base and control circuits. The few cables necessary are also provided with plug connections. Bulky wiring and troublesome soldering joints which might hamper service and assembly work are thus eliminated.

Extension cards are available so that all test points on the printed-circuit cards are readily accessible.

#### Plug-in units

##### Pre-scaler plug-in PM 6632

The basic PM 6640 covers the frequency range up to 225 MHz, (VHF band). For those, who need to make measurements in the UHF range, a pre-scaler plug-in unit, the PM 6632, is available. Combined with this fully automatic unit the PM 6640 can directly measure signal frequencies up to more than 800 MHz at 25 mV sensitivity

##### Pre-amplifier plug-in PM 6633

This permits extra low-level measurements within the VHF region. The PM 6640/PM 6633 combination accepts signals down to 500  $\mu$ V<sub>rms</sub>, thus permitting convenient measurements to be made using a proximity probe.

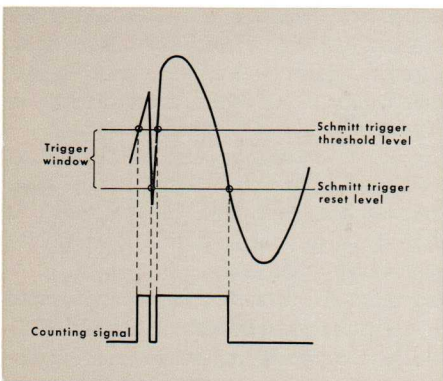

- Noisy signal applied to conventional input circuit. Additional triggering with resultant counting error occurs because noise extends beyond the trigger window
- The same signal applied to the PM 6640. The signal is now automatically amplified less, so that the noise no longer extends beyond the trigger window. Correct counting is thus obtained in spite of the noise pulse

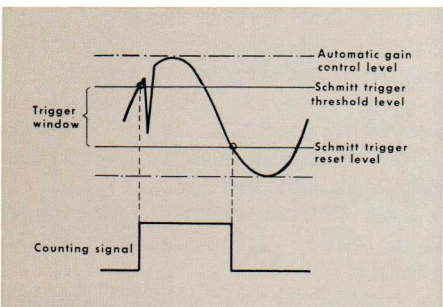

#### Automatic gain control

The input circuit of a frequency counter should have low noise and a gain which is optimum for the measurement in question. An input attenuator has generally been used to meet these requirements in the past.

However, this solution has some drawbacks: it involves time-consuming manual adjustment of the controls, a narrow dynamic range, a relatively low input sensitivity and the risk of counting errors if the signal-to-noise ratio is low.

The automatic gain control circuit of the PM 6640 eliminates all these disadvantages. The input signal is always optimally amplified so that external noise cannot interfere with the counting. The dynamic

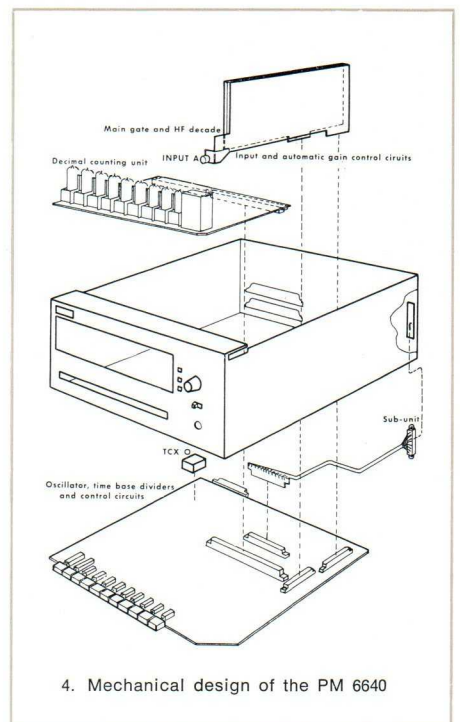

4. Mechanical design of the PM 6640

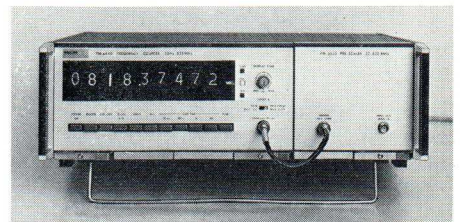

Prescaler PM 6632

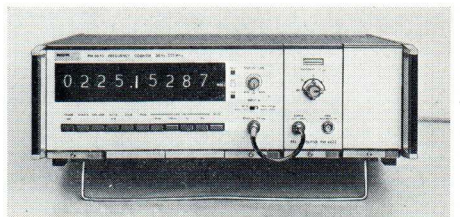

Pre-amplifier PM 6633



The remote-control card PM 9683 permits external programming of all functional modes, even the choice of input impedance.

The display time is preset to a fast range by means of an internal switch, which practically eliminates the need for manual adjustment during a measurement. The control signals are obtained by contact closure to earth or by bottomed transistors.

#### BCD-output card PM 9682

The BCD-output card PM 9682 provides a complete binary coded decimal code. It converts the TTL level of the counter into the fully buffered 12 V logic level used in Philips automatic systems, which gives improved resistance to noise.

Combined with the PM 9682, the counter can be e.g. used to drive a digital-to-analog converter, or incorporated in an automatic test system.

#### Oven-controlled crystal oscillator PM 9680

In some applications, e.g. checking crystal oscillators or accurate calibrations of generators, the stability of the counter's standard temperature compensated crystal oscillator (TCXO) may be insufficient. In this case the optional crystal oscillator PM 9680 can be used.

This has a crystal enclosed in a proportionally controlled oven, giving almost 100 times better temperature stability than the standard TCXO.

#### Microwave converter PM 6634

The PM 6634 is used in conjunction with Philips' systems counter PM 6640. It provides automatic measurement and direct read-out over a very wide range of microwave frequencies (0.8...12.6 GHz).

The 10 MHz signal from the basic crystal-controlled clock is amplified and multiplied by x20 and then applied to a step recovery, comb frequency generator. A YIG tuned filter selects one of the harmonics of this 200 MHz generator signal. The selected harmonic is used as local oscillator for a mixer and the unknown frequency is also applied to the mixer. If the difference frequency falls within the passband of the intermediate frequency amplifier, and has a suitable amplitude, the main counter unit starts counting the beat frequency. The frequency of the selected harmonic is already preset in the main counter and the difference frequency is then added to the display, giving a direct reading of the microwave frequency. For example, if a frequency of 10.475 GHz is fed to the input, the 10.4 GHz multiple is selected by the YIG-filter and is then preset to the three most significant digits of the main counter. The difference frequency - being 75 MHz - is then measured by the counter in the normal way and added to the preset value.

The YIG-filter is automatically tuned to consecutive harmonics by a staircase shaped current generator. Each step represents a 10 MHz increase in frequency. Approximately 120 steps are needed for a complete cycle. The dwelling time per step is 1 ms. The tuning starts from 800 MHz and stops when the threshold detector in the intermediate amplifier senses a sufficient beat signal.

Thus all tuning is automatic and no adjustments by the operator are required to obtain the correct output read-out.

#### Remote-control facility PM 9683

In automatic test chains, the counter employed should not represent a weak link by reason of its need for manual adjustment. This trouble can be avoided by using the PM 6640 with the remote-control and BCD-output plug-in cards.

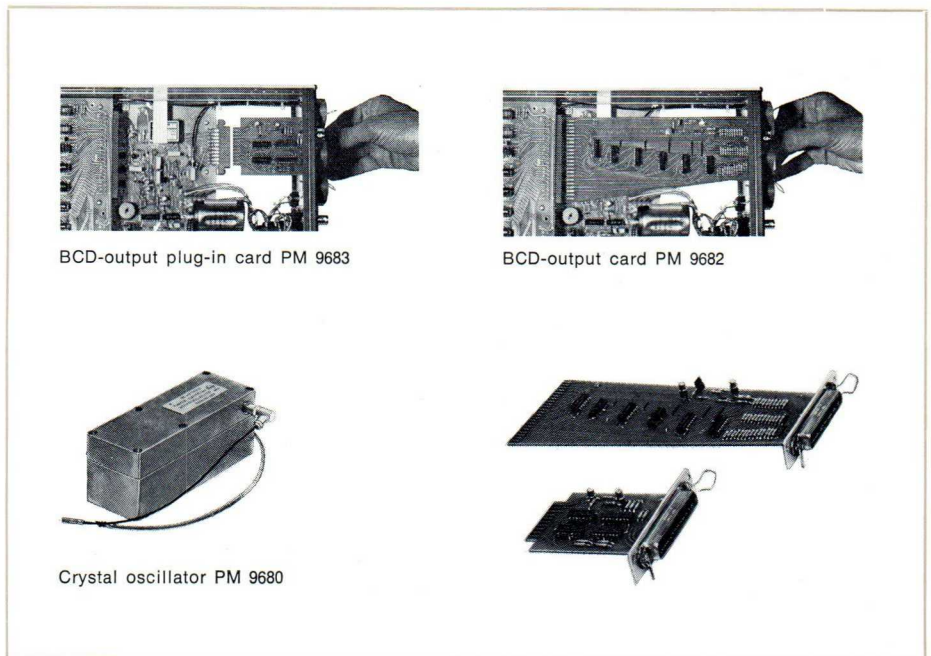

BCD-output plug-in card PM 9683

BCD-output card PM 9682

Crystal oscillator PM 9680

### Technical specifications

#### OPERATING MODES

##### Frequency

Range: 30 Hz...225 MHz  
Gate time: 10 ms...10 s (in decade steps)  
Accuracy:  $\pm 1$  count  $\pm$  time base error

##### Ratio/Multiple ratio

Frequency range:  
input 1 : 30 Hz...225 MHz  
input 2 : 10 kHz...10 MHz

##### Check

Counts internal 10 MHz clock frequency

#### INPUT CHARACTERISTICS

##### Main input (input 1)

Impedance:  $1\text{ M}\Omega/15\text{ pF}$  or  $50\ \Omega$   
Sensitivity:  $10\text{ mV}_{\text{rms}}$  (30 Hz...225 MHz)  
Attenuator: automatic  
Coupling: AC  
DC-block:  $250\text{ V}_{\text{DC}}$   
Overload:

Input protected against  $220\text{ V}_{\text{AC}}$  in  $1\text{ M}\Omega$  position,  
 $12\text{ V}_{\text{max}}$  in  $50\ \Omega$  position

##### Rear input (input 2, ext. reference input)

Impedance:  $1\text{ M}\Omega/50\text{ pF}$   
Sensitivity:  $50\text{ mV}_{\text{rms}}$   
Coupling: AC  
Overload:  $220\text{ V}_{\text{rms}}$  or  $250\text{ V}_{\text{DC}}$   
External standard: 100 kHz, 1 MHz or 10 MHz

#### OUTPUT CHARACTERISTICS

##### Internal 10 MHz clock

Amplitude:  $> 1\text{ V}_{\text{rms}}$  into  $1\text{ k}\Omega$   
Coupling: AC  
Ri: approx.  $1\text{ k}\Omega$

##### Display time

2-50 ms; 0.2 - 5 s or infinite

#### GENERAL

##### Read out

9 long life numerical display tubes with automatically displayed decimal point 'GO' lamp indicates that sufficient signal is available for correct counting 'OSC' lamp on when power cord is connected indicates that crystal oscillator is working 'GATE' lamp indicates when gate is open  
Measuring units: kHz, MHz and GHz

##### Clock

Frequency: 10 MHz  
Type: T.C.X.O.  
Aging:  $\pm 1 \cdot 10^{-6}/\text{year}$   
Average: temp. coefficient:  $1 \cdot 10^{-6}/^\circ\text{C}$   
(Optional high stability clock, PM 9680)

##### Environment

Temperature range:  $0^\circ\text{...}45^\circ\text{C}$

#### OPTIONS

PM 9680 High stability clock

PM 9682 BCD-output

PM 9683 Remote programming input

PM 6632 Automatic prescaler plug-in

PM 6633 Preamplifier plug-in

PM 6634 Frequency converter



# The Philips Stirling engine

by A. Harrewijne, Philips' Research Laboratories, Eindhoven

After a brief description of the principle and execution of the Stirling external-combustion engine as developed by Philips, the use of electronics in the testing of the engine is discussed

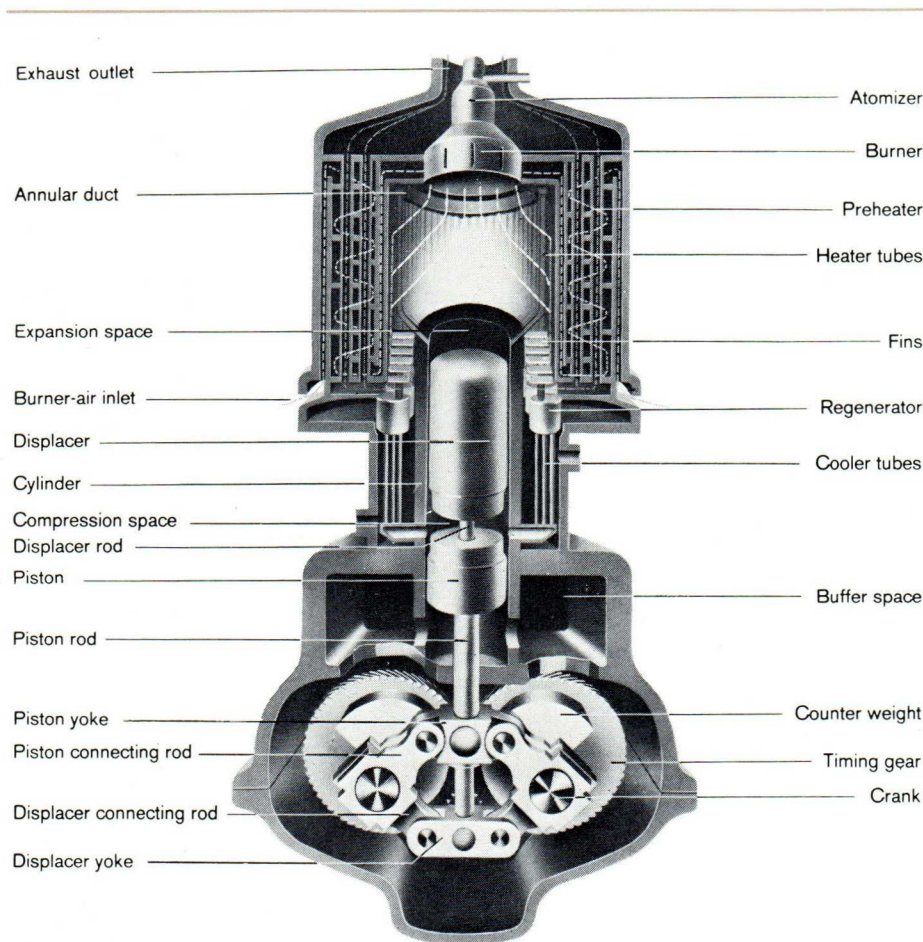

1. Philips Stirling engine shown in cross section. Piston and displacer drive concentric rods coupled to the rhombic drive turning twin timing gears. Cooler, regenerator and heater are annular units surrounding the cylinder. In the preheater the 800°C gas from the heater is cooled to 150-200°C while heating the combustion air to a temperature of about 650°C

dynamic cycle with unique features which made it possible for the development from the original prototype to proceed along two distinct paths: towards engines (largely for traction and related purposes) with powers of up to hundreds of HP; and towards refrigerating machines which are marketed successfully for the liquefaction of air and other purposes. We shall not consider this latter application any further here.

## The Philips Stirling engine

Research into the Stirling engine, formerly known as the hot-air engine, was begun at Philips as early as 1938. At that time the company was looking for a heat-driven electric generator for radio receivers and similar equipment that could be used in parts of the world without a public electricity supply and where the fuel needed for such a generator would be easier to obtain than batteries. The hot-air engine was eventually chosen. This engine, based on a principle patented by the Scottish minister Robert Stirling in 1816, met the requirements for the purpose envisaged - firstly quiet operation, secondly suitability for a variety of fuels (a "multi-fuel" engine) due to the external heating system, and thirdly reliable operation.

The Stirling system aroused even more interest when it was realized that, in the hot-air engines of the time, neither the development of heat- and creep-resistant materials nor modern knowledge of fluid dynamics and heat transfer had been applied to their design. There were, therefore, wide prospects. A brief description of the engine will first be given to explain the Stirling cycle.

## The Stirling cycle

An internal combustion engine provides a surplus of work when a quantity of air is compressed inside it at a low temperature, either before or after the addition of the fuel; the mixture is then rapidly heated by combustion and the gases produced are allowed to expand at a high temperature.

## Introduction

Nowadays, electronics is indispensable in the field of mechanical engineering. Electronic measuring and recording instruments have, for example, become essential aids in the development and testing of engines. A more recent development is the use of electronic control systems for motor-driven vehicles; the use of such control systems may be expected to be-

come much more wide-spread in the future.

We thought that the readers of these Notes might like to learn more about the application of electronic measuring instruments to the Philips Stirling engine, an interesting product of Philips' research activities. This engine, which was originally intended as a power source for radios in areas where electricity supplies were not readily available, is an "external-combustion" engine working on a thermo-



The present trend is on the one hand towards traction engines for buses and trucks with powers of up to 300 HP, and specific weights which make them comparable with diesel engines; and on the other hand towards light traction engines comparable with petrol engines for passenger cars.

One advantage of these Stirling engines which was never envisaged by their inventor is the fact that the combustion conditions lend themselves very well to the production of very "clean" exhaust gases; wide-spread use of these engines would thus lead to a considerable reduction in air pollution.

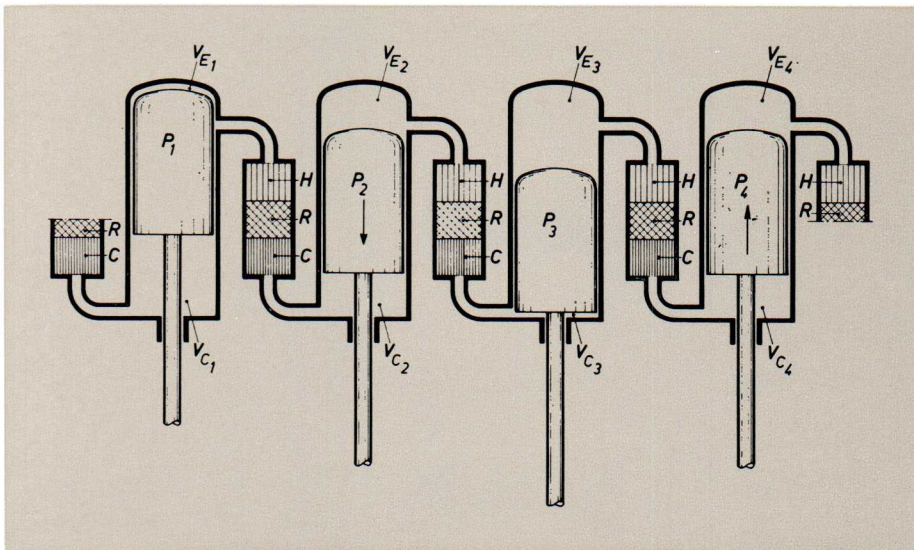

2a. Principle of the double-acting engine. There is a hot space - expansion space - at the top and a cold one - compression space - at the bottom of each of the four cylinders shown. The hot space of a cylinder is connected to the cold through a heater, a regenerator and a cooler. The pistons  $P_n$  of the cylinders move with a suitable phase shift between them. In the case of four cylinders as shown here, this shift is  $90^\circ$

The same principle, i.e. the compression at low temperature and expansion at high temperature of a given quantity of gas, is the basis for the Stirling engine. Here, however, the gas is heated in a totally different way: the heat is applied to the gas from outside, through a wall. Owing to the high heat capacity of the wall, it is not of course possible to heat and cool the gas simply by heating and cooling of the wall if an engine speed of 1 r.p.m. or more is required. (Engines for pumping water from mines, etc., with heat transfer through the walls - both heating and cooling - were in fact widely used in practice both before and after Stirling's time).

Stirling had realized as far back as 1816, however, that the gas temperature could be made to change periodically by causing a "displacer" he called it a "plunger" to transfer the gas back and forth between two spaces, one at a constant high temperature and the other at a constant low temperature.

Fig. 1 shows a diagrammatic cross-section through a "first-generation" Stirling engine, in which the motions required of the displacer and the piston are realized by the "rhombic drive" to be seen in the crankcase at the bottom of the figure. This rhombic drive allows the use of an unpressurized crankcase. A further advantage is that it allows the centre of gravity of the whole system to remain stationary during one revolution of the crankshaft. This gives perfect balance which, thanks to the vertical symmetry of the rhombic drive, also extends to higher harmonics.

Further research has now led to the development of "double-acting" engines in which there are no separate pistons and displacers. The principle of this system is illustrated in fig. 2. Its main advantage is that it leads to a very compact design. Most of the work done on the Stirling engine to date has been done on engines with a rhombic drive, but the further development going on at the moment is all based on the double-acting system.

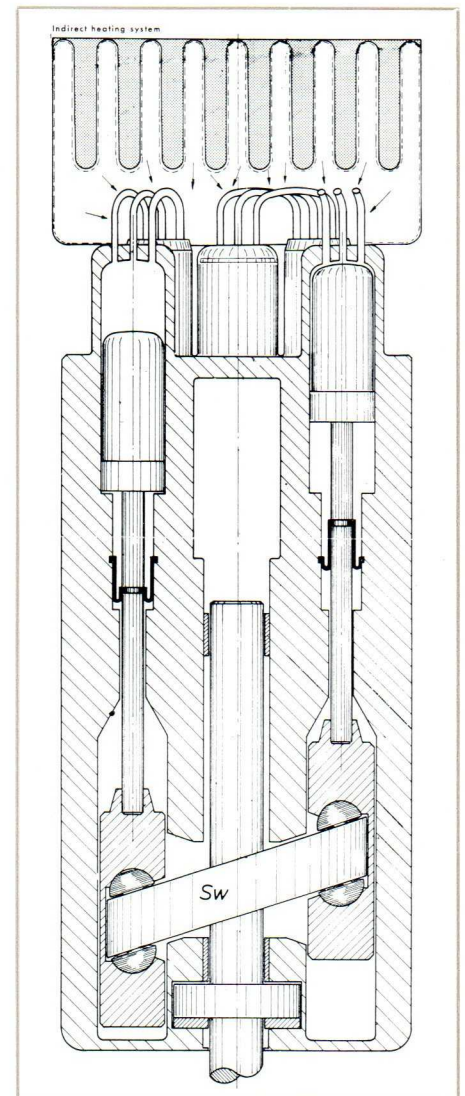

2b. Engine of the type of fig. 2a. Two of the four cylinders are shown in cross-section, and part of a third may be seen at the middle in the rear. The motion of the pistons is transmitted to the main shaft by the swash-plate Sw.



### Test measurements on the Philips Stirling engine

A photo of part of a permanent test set-up for a (second-generation) Stirling engine with swash-plate drive, designed for 60 HP at 3000 r.p.m., is shown in fig. 3. The block diagram of this set-up is shown in fig. 4. The measurements carried out by this installation are as follows:

- a. fuel consumption (by weighing); this is required for the heat balance of the engine;
- b. permanent recording of the temperatures at a number of points; these temperatures are sensed, in general, with thermocouples and recorded with Philips PR 3500 recorders or in some cases with the more recent PM 8100 flat-bed recorders. These temperature measurements

measurements (on the combustion air, cooling water, lubricating oil, etc.) for the heat balance.

c. volume flow rates of combustion air, cooling water and lubricating oil, for the heat balance.

d. permanent recording of the pressure in the cycle with the aid of quartz-crystal pressure transducers. A typical pressure-time curve is shown in fig. 5. This is required for the heat balance, and furthermore for calculation of the mechanical power.

e. engine torque

f. engine speed

g. conventional heat flow from the crankcase to the air. This measurement replaces the theoretical estimation of the quantity in question, and is realized with

The pressure signals may be recorded on magnetic tape, or with the aid of a high-speed UV recorder. The magnetic tape recording of the pressure signals, together with the synchronization signals from the shaft of the engine, is realized with the aid of a Philips Analog 7 tape recorder. This tape may be used as the input for a computer which, with the aid of a suitable programme, prints out pressure-angle and pressure-volume curves (see fig. 6) and calculated values of the power (which may be determined directly as the area enclosed by the pressure-volume curve).

In the "old days" of Philips' Stirling-engine research, the equipment available did not allow accurate determination of the pressure-volume relation; the power thus had

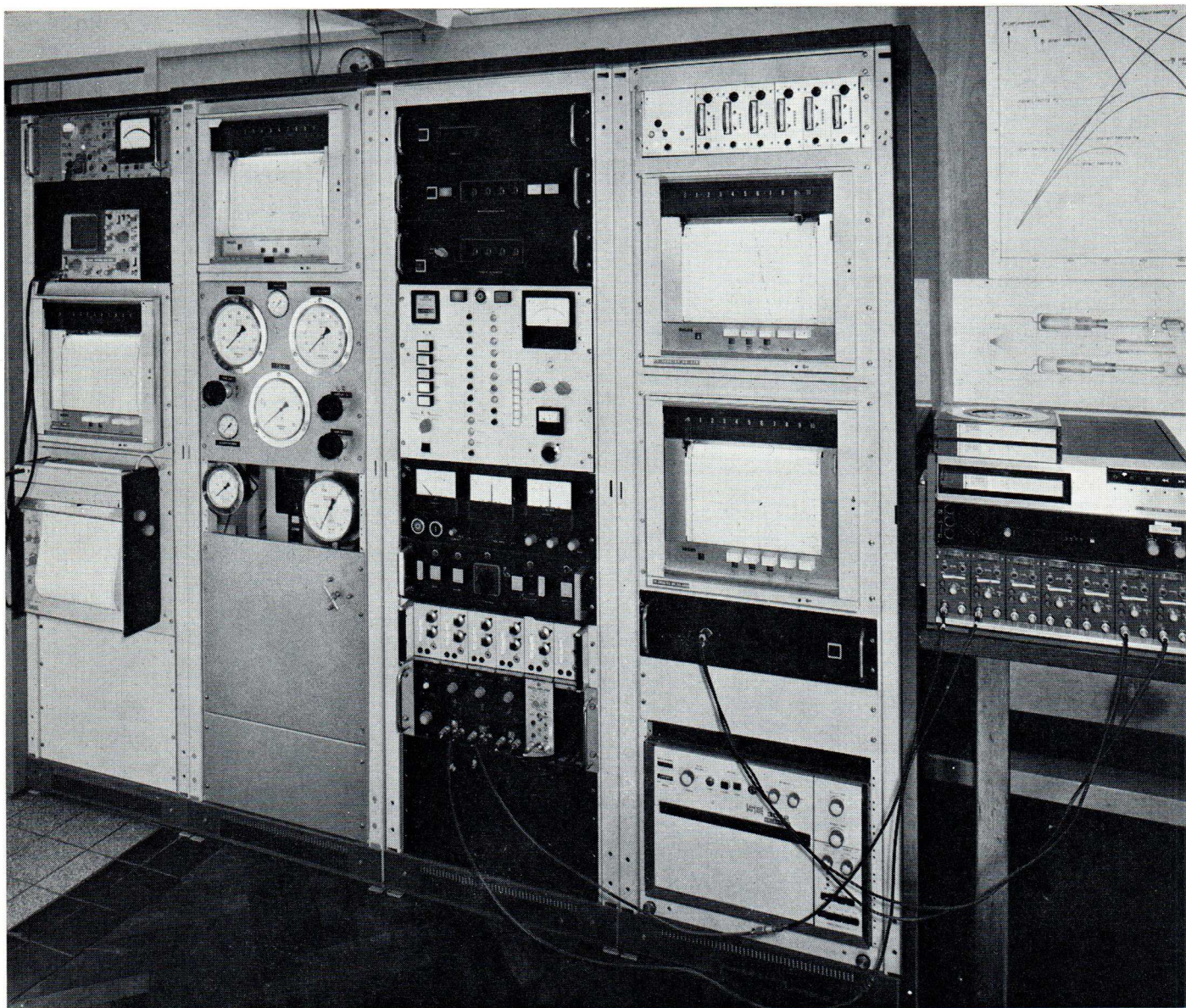

3. Part of the permanent test set-up for a second-generation Stirling engine with swash-plate drive, designed for 60 HP at 3000 r.p.m.

may be divided roughly into two groups: high-temperature measurements at various points on the heater, in the interests of materials research and the design of better heater heads; and low-temperature mea-

an ingenious instrument from the USA, which makes use of a transducer in the form of a disc about 2 mm thick, measuring the temperature difference across the thickness of the disc with the aid of about 1000 thermocouples in series (made with the aid of semiconductor integrated-circuit techniques).

to be calculated with the aid of an approximate expression involving the phase  $\theta$  of the pressure, which could be estimated quite accurately with the aid of a membrane-type pressure transducer built on to



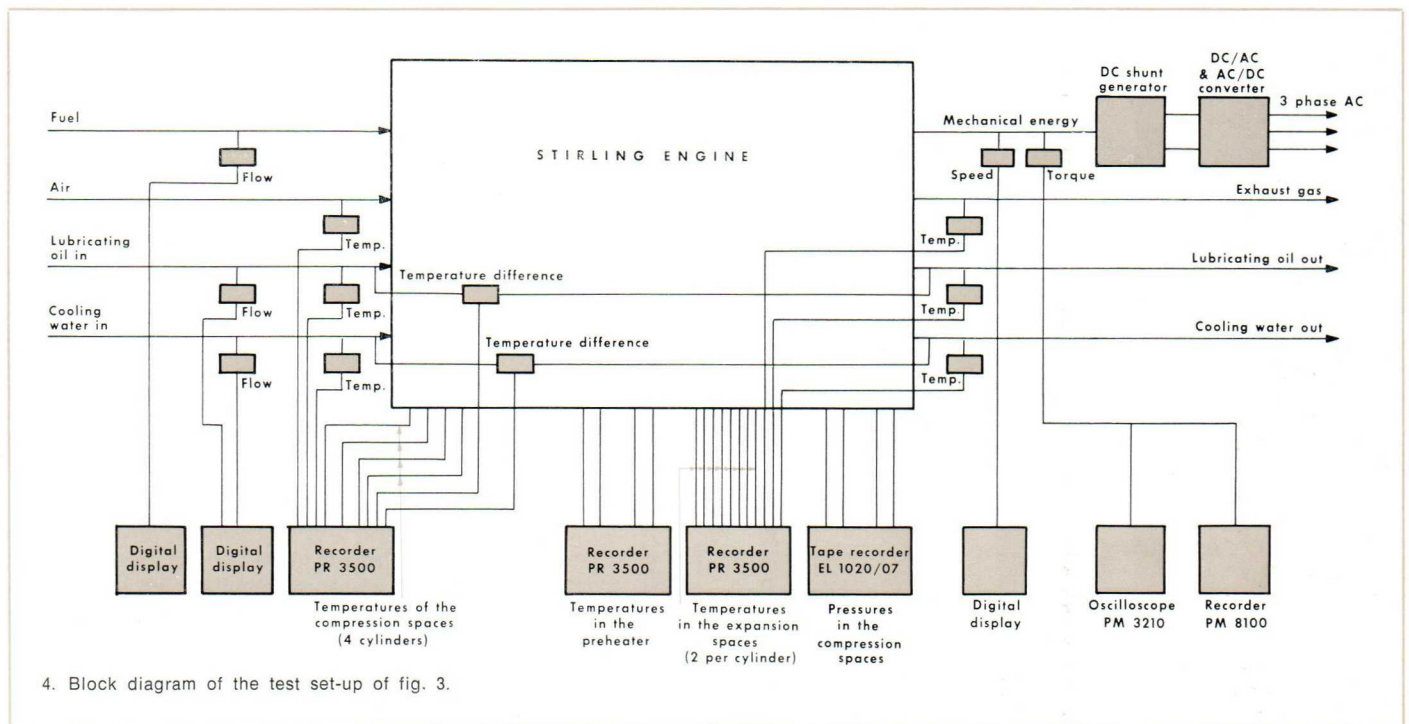

the engine; however, the whole operation was quite time-consuming and rather delicate.

Nowadays, the development of sensitive, accurate quartz-crystal pressure transducers together with advances in the associated electronic circuitry (especially the amplifiers, which are also marketed by Philips under the type number PR 9345 makes it possible to record the pressure-volume curve with sufficient accuracy to calculate the power accurately in this way. Within about six months, it is hoped to complete a fully automatic test bed making use of a Philips computer; the PR 3500 recorders will still be used in this new set-up. The pressure and other signals can then be fed directly to the computer, thus eliminating the use of the tape recorder.

Another feature of the test bed which may be mentioned briefly is the electronically controlled braking system which is used as a "power sink" for the Stirling engine.

In order to get rid of the power produced by the Stirling engine, it has been coupled to a DC motor which feeds its DC current into a solid-state DC three phase AC converter giving a voltage which can be fed back into the mains. This whole set-up can be braked to an adjustable extent by means of the Ward-Leonard principle. This system makes up an important part of the test bed, as regards both the space occupied and the complexity of the electronic circuitry involved. This system could in principle be used to measure the brake horse power of the engine, but under the prevailing test conditions it is more convenient to calculate this from the P-V diagram.

#### Regulating the engine output

It has been found that the cycle pressure is the most suitable parameter for regulating the power output, in relation to life and efficiency. However, the question arises whether this method of regulation can be so arranged for different practical

cases that the engine will invariably respond rapidly, since, for changing the mean pressure, working gas must be pumped in or out to raise or lower the power. Because the working gas is helium or hydrogen, the engine can be filled to full load pressure very quickly - e.g. in a time of 0.2 s - through tubes of normal cross-section from a small, high-pressure steel bottle, at a pressure of 200-300 atm. On the other hand, however, the gas cannot be pumped out quickly enough, particularly since only a small control compressor can be used to pump the gas back into the bottle. The filling and dumping system has therefore been combined with a bypass or short-circuit system, which immediately gets rid of the excess power. The way in which this arrangement works is shown in fig. 7.



If the power is to be increased the governor device opens the supply valve, and gas then flows from the reservoir into the engine. This process continues until the desired power output is attained. Depending on the valve opening and the pressure in the reservoir, the whole process can take place very quickly. If the engine power is to be decreased the governor opens the dump valve and, almost simultaneously, the bypass valve too, which immediately changes the phase and amplitude of the pressure, and thus the torque, to an extent governed by the degree to which this valve is opened. The gas is pumped back from the engine through the control compressor into the reservoir. The more working gas is pumped out of the engine, the less power need be bled off

and the more the bypass valve shuts. This bypass channel is completely closed when the gas pressure is attained at which the desired power output is produced. The control compressor is generally of such a size that the loss-free state is attained within half a minute going from full load to idle. This compressor can therefore be kept relatively small but can, of course, be adapted to suit a particular case. In fact, the speed controls of the Stirling engine are realized in the form of a feedback system, the block diagram of which is given in fig. 8. This system is used both for keeping the engine speed constant at a given value (max. 3000 r.p.m.) and for varying the engine speed. The engine speed is converted into a voltage with the aid of a tachogenerator; this

# Digital instrument course

by A. Bouwens

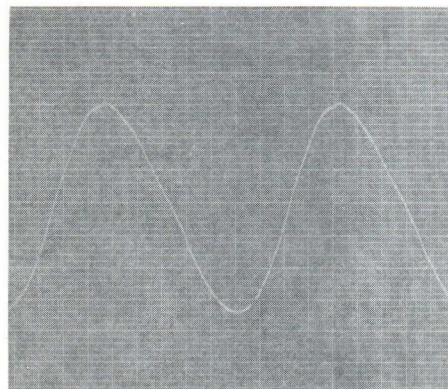
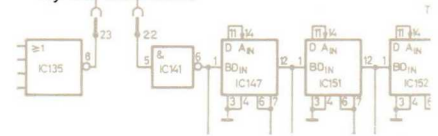

5. A typical pressure-time curve

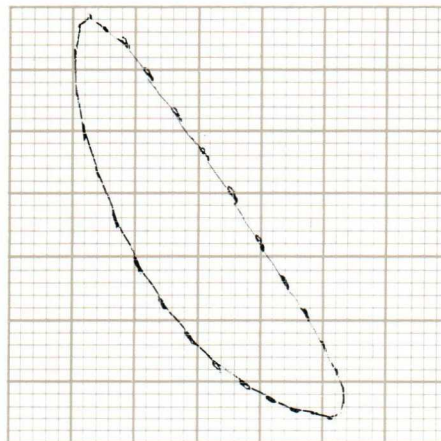

6. Pressure-volume curves

Nowadays, an increasing number of electronic measuring instruments are 'going digital', digital circuitry, digital readout and digital remote control often being combined in the one instrument.

The newcomer to the field of digital techniques is faced with an abundance of articles, courses etc. devoted to the fundamentals of digital circuits. Much less, however, has been written about the use of such circuitry in measuring instruments. Such information is important, because it enables the user of digital equipment to make the best possible use of the various facilities offered.

In order to satisfy this need, a four-day course in digital instrumentation was given a number of times in 1971 for the instrument specialists of our European sales organisation. This course was such a success that we thought it might be worth while repeating it in condensed form in these Notes.

The course will be divided into five parts:

- 1) Basic binary theory and logic circuits
- 2) Digital timers and counters
- 3) Digital voltmeters
- 4) Data logging and small systems
- 5) Automatic measuring systems

The first instalment will appear in the next issue of these Notes. Each instalment will end with a number of multiple-choice questions the answers to which will be found in the subsequent issue.

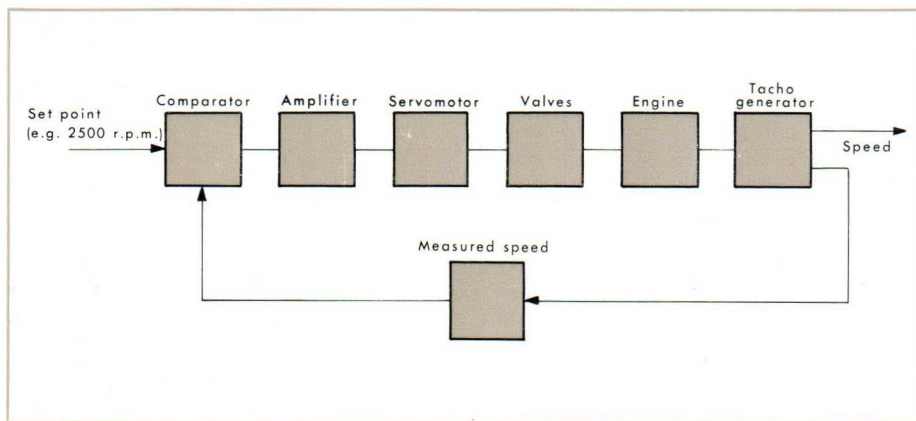

9. Block diagram of speed-control system for the Stirling engine

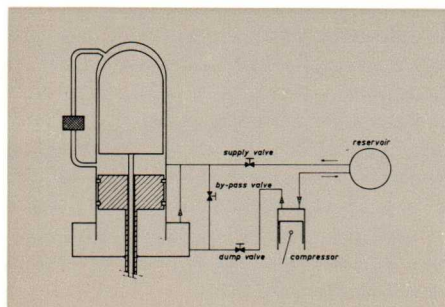

7. Regulation of the cycle pressure and the engine speed

voltage is compared with the set point, and the difference signal amplified, with the aid of a differential amplifier. The amplified voltage is applied to a servomotor, which operates the valves shown in fig. 7. so as to regulate the cycle pressure and hence the engine speed in the manner shown above.

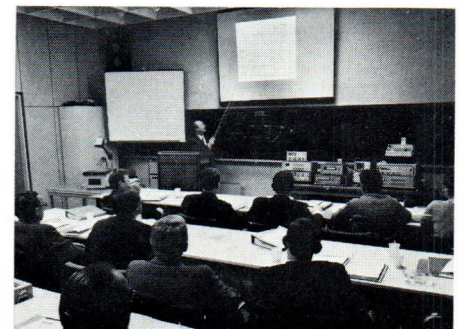



# ... .. a dead art?

by P. Zwart

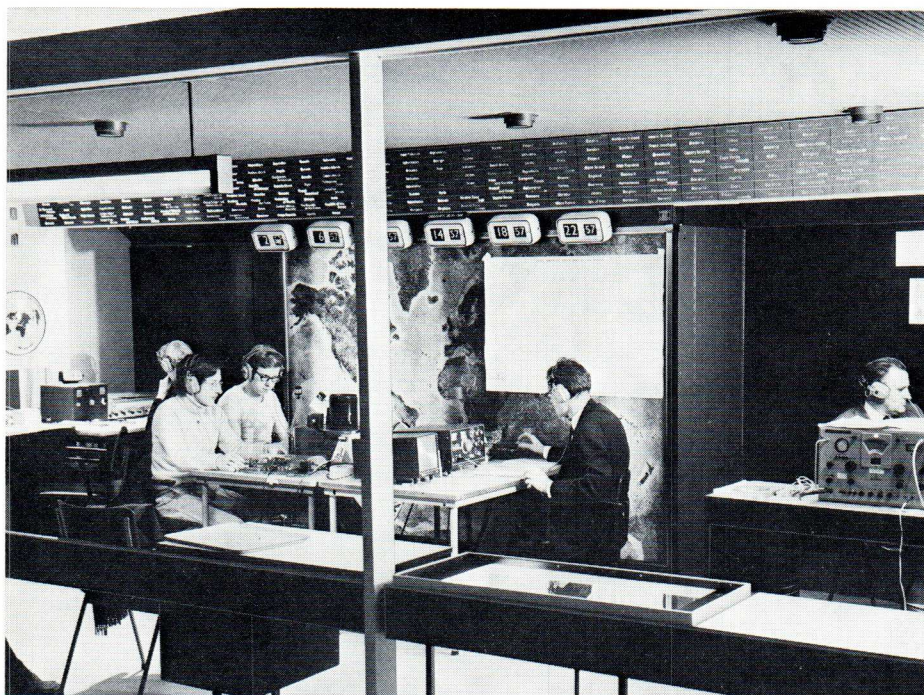

Present communication techniques cover an enormous field, from the relatively simple telephone line to complex data transmission systems. The range of frequencies employed extends from 15 kHz to well over 5.6 GHz.

Few people realise that the first attempts at wireless communication took place in the VHF region. Subsequent development, however, was confined to the field of low frequencies and VHF was temporarily abandoned. Commercial stations began to appear, and radio amateurs, alive to the magic of the new science, played an increasing role in its development. It was the amateur, in fact, driven to the higher frequencies in an attempt to clear the air for commercial use, who discovered the possibilities of short-wave (2 to 30 MHz) transmission.

Intercontinental communication then increased rapidly, especially in the world of commercial broadcasting. But, as experience in the use of short-waves increased so did an appreciation of their disadvantages. High reliability, for one, could not be guaranteed: the short-waveband was particularly prone to interference from the occasional magnetic storm. Sun-spot activity, extremely difficult to predict, aggravated the situation; and so the move to yet higher frequencies started. Radio communication, once again, adopted the VHF band. Range was limited at first to the radio-horizon (1.3 times the optical horizon), the isolated cases of beyond-horizon propagation being attributed to unexplained vagaries in the transmission path. But the design of more powerful transmitters lead to the discovery of interference-free scatter signals. These signals, which can be detected over enormous distances, and the new techniques of satellite communication, open large and expanding fields for the future.

Man's progress in the science of communication has been marked by many interesting discoverers.

In this, the first in a series of short articles, the question "Morse, a dead art?" is answered.

The advent of voice communication in 1907 did nothing to discourage the use of Morse telegraphy. The more recent introduction of frequency modulation and single side-band techniques, however, so improved the quality of voice transmissions that the need for proficiency in Morse became less pronounced. Teletype, a very reliable technique thanks to the latest correction methods, has also had the effect of reducing the interest in Morse. Morse telegraphy is, nevertheless, still a part of the training programme for professional radio operators. It is used extensively in ship-to-shore traffic and as a standby in cases of emergency.

Another, enthusiastic, group of Morse users is formed by the radio amateurs. In the drastically reduced bands set aside for their use a large number of amateurs are still lured by the romance of Morse, the first language of the air. Interest is stimulated by organised contests in which the operator's skill is put to the test. Radio amateurs are to be found everywhere, but it is not a coincidence that a large number are employed in the electronics industry. This applies also to Philips. In a recent world-wide contest, organised by an American radio magazine, more than 20 Philips employees were entered. They joined together in the Eindhoven Evoluon, where the amateur station PE2 EVO is located. The aim was to establish as many radio contacts as possible in a 48 hour period using six different amateur bands, from 1.6 to 30 MHz. The result was more than 2000 contacts all over the world.

A professional radio operator would become hopelessly confused with the enormous number of radio stations (and the consequent interference) on such a limited frequency band. But the amateur uses 'state of the art' equipment having a bandpass of approximately 300 Hz, full break-in facilities and automatic electronic keys.

It can be seen that the art of Morse is still alive - it will remain so long after the last commercial telegraphy transmitter has become a silent key.



# PHILIPS

## New products



PM 5546 video calibration generator which provides high-precision test signals for TV studio and transmitter work

### TV studio/transmitter test-signal accuracy needs met in video calibration generator PM 5546

High-accuracy television test signals which can be fed directly into standard TV-studio set-ups are provided in a video calibration generator intended for the precision alignment of studio/transmitter monochrome and colour-television equipment. Designated the PM 5546, this instrument can generate such test signals either separately or simultaneously, and provides that extra precision often needed in accurately aligning and checking of studio cameras, colour encoders and decoders, monochrome and colour monitors, etc. Signals provided by the PM 5546 include a crosshatch/dot pattern, a grey scale, a PLUGE signal, a white reference signal, colour-bar signals, and individual colour and colour-difference signals. The cross-hatch/dot pattern is intended primarily for convergence alignment of CTV monitors and receivers but is also used for linearity,

checks and aspect-ratio adjustments. It is available in a 14 x 19 format that employs either lines or dots. The grey scale, which can have either 6 or 11 levels, is used mainly in checking the linearity of TV monitors, and is particularly useful where "tracking" errors need to be detected. Very significant here is the 0.5% accuracy on signal-level setting, something believed to be unequalled elsewhere for this type of test signal.

### Colour-bar signals meet EBU and BBC needs

In the case of the colour-bar signals, these can be adapted to the requirements of the various national TV authorities simply by changing an internal connection. Intended for aligning colour encoders as well as for checking test-signal distribution systems employed in TV receiver production plants, these signals can be provided in EBU and BBC standard formats as well as in other formats. Here again the signal-level accuracy provided,  $\pm 0.25\%$ , is believed to be unique for this type of test signal.

The PLUGE signal is employed primarily to permit equal adjustment of monitor-picture light intensity and contrast. Use of this signal makes sure that any variations in these parameters from monitor to monitor are eliminated and that such variations no longer act as a source of potential error when observing several picture monitors simultaneously.

Prime application of the PM 5546's high-accuracy ( $\pm 0.25\%$ ) white reference pulse is in the calibration of video test-signal sources similar to the PM 5546. Included

among such sources are video test-signal generators and VITS generators.

### Separate and simultaneous signal outputs provided

Apart from these basic performance characteristics, another important feature of the PM 5546 is that all its output signals can be provided separately and/or simultaneously with or without sync. In the first instance they are taken from separate outputs, but when supplied simultaneously are taken out via one of the instrument's RGB outputs. In the latter instance, this mode of operation ensures that the signals can be fed directly into TV studio/transmitter encoders and eliminates the need for any complex interconnection arrangement. Also important is the remote-control output which permits the instrument to be remotely controlled or programmed. This facility is assuming growing importance now that more and more studio and transmitter test operations are being carried out automatically.

Addition of the PM 5546 to Philips range of professional television test equipment means that the company can now provide such equipment to meet virtually every test need. Introduction of this new instrument, which is available as either bench or rack-mounted models, meets particular needs for a unit that provides a broad range of high precision test signals from a single source. Apart from its use in studio/transmitter applications, this instrument is also very useful in broadcast service workshops, in video switching centres, in large closed-circuit TV systems, and in TV equipment development departments.