



RADIOTRONICS

AMALGAMATED WIRELESS VALVE CO. PTY. LTD.

BOX No 2516BB, G.P.O., SYDNEY

TECHNICAL BULLETIN No. 101 20th December, 1939

In this issue:—

	Page		Page
"Radiotron Designer's Handbook"	59	New Ratings for Transmitting Valves	67
Effect of Grid Coupling Condenser	60 - 61	Radiotron 811 and 812	67
Filter for Bass Boosting	62	Radiotron 811—Illustration	68
Notes on 1.4 Volt Valves	63	Radiotron 899—Announcement	68
Radiotron 1T5-GT—Data	63	Radiotron 893—Tentative Ratings	68
Radiotron 3Q5-GT—Data	64	Radiotron 828—Data	69
Valve Type Numbers—Note	64	Radiotron 828—Illustration	69
Radiotron 6AG7—Data and Application	65 - 66	Radiotron News	70
Standard Intermediate Frequency	67		

AT the close of yet another successful year in the publishing of "Radiotronics", the Management and Staff of Amalgamated Wireless Valve Co. Pty. Ltd. extend to each and every reader their best wishes for Christmas and the coming year coupled with the sincere appreciation for the encouragement and help which has contributed so much to make "Radiotronics" a real help to subscribers.

In 1940 our efforts will, once again, be directed towards providing the latest information on technical matters associated with valve application.

RADIOTRON DESIGNER'S HANDBOOK

The third edition of the Radiotron Designer's Handbook is at present in the course of being printed, and is expected to be available about the end of December. Copies will be obtainable through principal booksellers at a price of 3/-, or from Amalgamated Wireless Valve Co. Pty. Ltd., 47 York Street, Sydney, at a cost of 3/-, plus postage.

This Handbook has been completely rewritten from cover to cover and very much enlarged, so that it is now an invaluable book of reference to all those engaged in radio engineering. It includes 40 chapters in all, covering the following subjects:

- Radio Frequencies
- Rectification
- Filtering
- Receiver Components
- Tests and Measurements
- Valve Characteristics
- General Theory
- Tables, Charts and Sundry Data.

A large proportion of the material is unobtainable from text books or other sources, and has been written specially to meet the demand for such information. Very complete treatment has been given on negative feedback, tone compensation, tuned circuits, rectification, filtering, transformers, receiver tests and measurements, valve testing, valve voltmeters and the graphical representation of valve characteristics.

The matter is copiously illustrated with diagrams, and a large number of curves have been given for the graphical solution of special problems. Useful tables have also been given, including very complete tables of capacitive and inductive reactances, and the impedance of a resistance and capacitance in parallel.

This Handbook, with its 300 pages, has been produced as a Radiotron service, and should be in the possession of every reader of Radiotronics. For your convenience an application form is enclosed with this Bulletin.

RESISTANCE CAPACITANCE COUPLING ATTENUATION DUE TO GRID COUPLING CONDENSER

The attenuation at low frequencies due to the grid coupling condenser in a resistance capacitance coupled amplifier may be accurately

calculated from the expression for the overall stage gain:—

$$M = \frac{g_m}{\sqrt{\left(\frac{1}{r_p} + \frac{1}{R_L} + \frac{1}{R_g}\right)^2 + \left(\frac{1}{\omega C R_g}\right)^2 \cdot \left(\frac{1}{r_p} + \frac{1}{R_L}\right)^2}} \quad (1)$$

where M = the gain of the stage from the grid of the preceding valve to the grid of the following valve.
 g_m = the mutual conductance of the preceding valve at the operating plate current.
 r_p = the plate resistance of the preceding valve at the operating plate current.
 R_L = the resistance of the plate load resistor.

R_g = the resistance of the grid resistor of the following valve.
 C = the capacitance of the grid coupling condenser.
 $\omega = 2\pi f$.
 f = the frequency at which M is calculated.

To simplify calculations, the expression (1) may be put into the more convenient form:—

$$M = \frac{g_m}{\left(\frac{1}{r_p} + \frac{1}{R_L} + \frac{1}{R_g}\right)} \cdot \frac{1}{\sqrt{1 + \left(\frac{1}{\omega C R_g}\right)^2 \cdot \left(\frac{\frac{1}{r_p} + \frac{1}{R_L}}{\frac{1}{r_p} + \frac{1}{R_L} + \frac{1}{R_g}}\right)^2}} \quad (2)$$

The first term on the right hand side of the expression (2) is then the **normal stage gain**, and the second the **fraction by which it is reduced** due to the reactance of the grid

coupling condenser at the frequency at which M is calculated. The **attenuation in decibels at any frequency, due to the grid coupling condenser**, is then given **exactly** by the expression

$$\text{Attenuation (db)} = 20 \log \frac{1}{\sqrt{1 + \left(\frac{1}{\omega C R_g}\right)^2 \cdot \left(\frac{\frac{1}{r_p} + \frac{1}{R_L}}{\frac{1}{r_p} + \frac{1}{R_L} + \frac{1}{R_g}}\right)^2}} \quad (3)$$

When the preceding valve is a **general purpose triode**, for which the plate resistance is of the order of 10,000-20,000 ohms,

$$\left(\frac{1}{r_p} + \frac{1}{R_L}\right) \gg \frac{1}{R_g} \quad (4)$$

and the expression (3) for the attenuation may be reduced without appreciable error to the

approximation

$$\text{Attenuation (db)} = 20 \log \frac{1}{\sqrt{1 + \left(\frac{1}{\omega C R_g}\right)^2}} \quad (5)$$

For convenience, this relation has been plotted as the family of curves given in Fig. 1. Each curve corresponds to a single value of coupling condenser and the attenuation in decibels is

plotted against frequency in cycles/sec. when the value of the grid resistor of the following valve is 1 megohm. For other values of grid resistor, the value of coupling condenser to give the same attenuation may be readily obtained by multiplying the value of C, shown by the curves, by the reciprocal of the grid resistor in megohms. For example, if the grid resistor has the value 0.5 megohm, the value of C should be multiplied by 2 to give the same

attenuation.

If the preceding valve is a pentode, its plate resistance will be extremely high, so that in general

$$\frac{1}{r_p} \ll \frac{1}{R_L} \text{ and } \left(\frac{1}{R_L} + \frac{1}{R_g} \right) \tag{6}$$

The expression (3) for the attenuation then simplifies without appreciable error in this case to the approximation

$$\text{Attenuation (db)} = 20 \log \frac{1}{\sqrt{1 + \left(\frac{1}{\omega C (R_L + R_g)} \right)^2}} \tag{7}$$

It will be seen that this approximation differs from the corresponding expression (5) for a general purpose triode, only by the addition of R_L to R_g in the second term in the denominator, so that the curves shown in Fig. 1 may also be used for a pentode, providing $(R_L + R_g)$, i.e., the sum of the resistance of the plate load resistor and the following grid resistor is equal to 1 megohm. In most cases, R_L has the value 0.25 megohm, so that the curves will then apply, within the limits of the approximation, when

the grid resistor has the value 0.75 megohm.

For values of $(R_L + R_g)$ other than 1 megohm, the values of C obtained from the curves must be multiplied by the reciprocal of the total resistance in megohms of the plate load resistor and following grid resistor. For example, if the value of the grid resistor together with the value of the plate resistor of the preceding stage is 1.25 megohms, the values of C should be multiplied by 0.8.

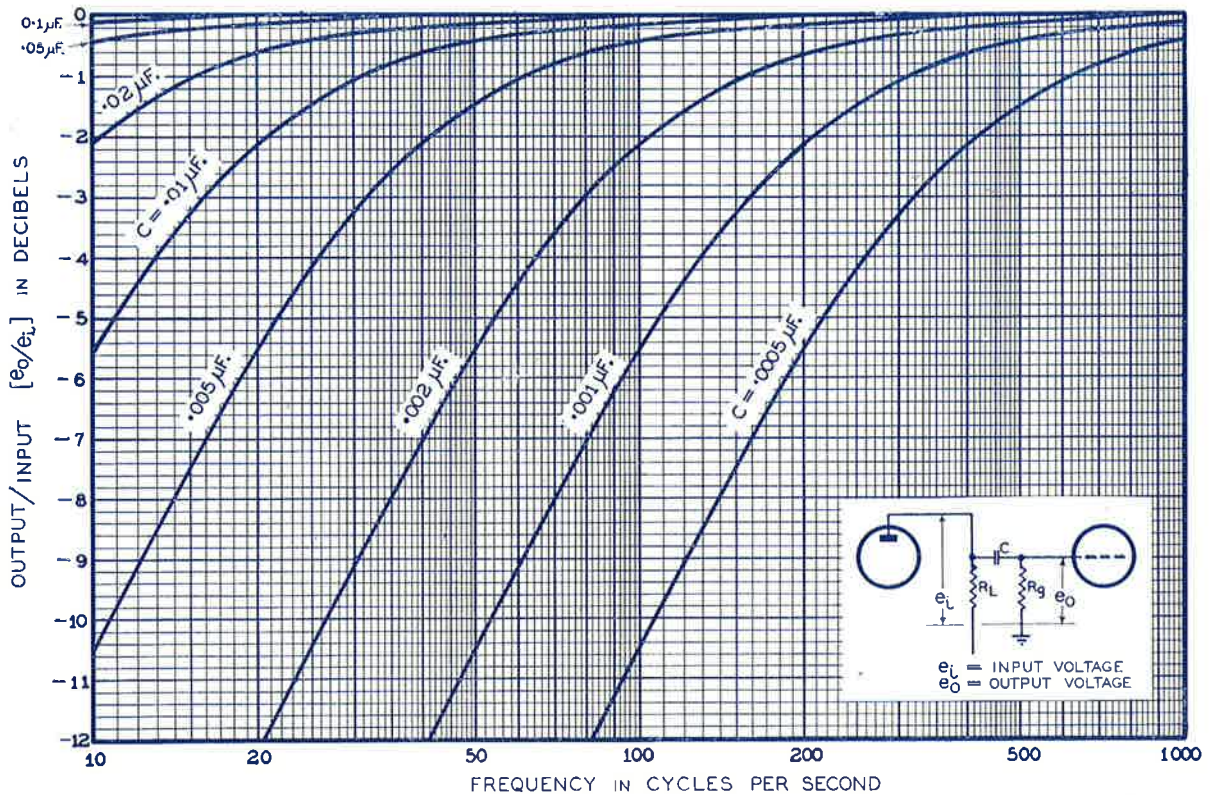

Figure 1. Attenuation characteristics of a grid coupling condenser with a grid resistor (R_g) 1.0 megohm, on the assumption that the plate resistance of the preceding valve is very small compared with R_g . Under all conditions a very close approximation is obtained by considering R_g , in series with the plate resistance and load resistance (R_L) of the preceding valve in parallel, as 1.0 megohm. Thus with a pentode valve having a load resistance of 0.25 megohm the curves hold closely for $R_g = 0.75$ megohm. If R_g is halved, the values of C should be multiplied by 2, and similarly for other ratios.

FILTER FOR BASS BOOSTING

APPLICATION TO PICK-UP

In all normal lateral cut recordings it is necessary for practical reasons, to restrict the amplitude of the cutter at the lower frequencies. Standard practice is to attenuate progressively all frequencies below 250 c/s at the rate of 6 db per octave. When reproducing such recordings it is desirable that the overall response of the pick-up and amplifier should be made to rise sufficiently at the lower frequencies to offset the attenuation introduced during the process of recording.

In cases where it is inconvenient to apply "bass boosting" in the amplifier, it may be found satisfactory to use a filter between the pick-up and the input terminals of the amplifier. A very simple circuit, which may be

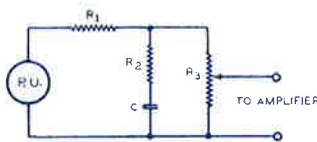

FIGURE 2.

Filter circuit for bass boosting intended for insertion between the pick-up and the grid of the first amplifier stage.

used for this purpose, is shown in Fig. 2. The values of R_1 , R_2 , R_3 and C need to be determined to suit the particular conditions. It will be obvious that at very low frequencies the voltage available will be greater than at middle or high frequencies, where the shunting effect of the condenser C becomes appreciable. Furthermore, if R_1 is made small with respect to R_3 the loss in the filter at low frequencies will be comparatively small.

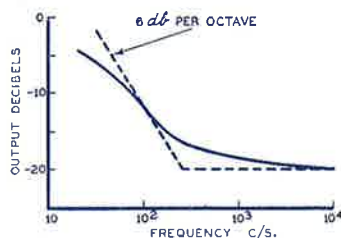

FIGURE 3.

Frequency Characteristic (Solid Line)

when $R_1 = .225$ megohm
 $R_2 = 25,000$ ohms
 $R_3 = 1$ megohm
 $C = .02 \mu F$.

Broken line indicates bass boost of 6 db per octave which is required for complete compensation of recording loss per below 250 c/s.

Figs. 3 and 4 show the characteristics obtained with particular values of components, the first with approximate a bass boost of 6 db per octave and the second to approximate 3 db per octave below 250 c/s. The values of these components are shown under the individual diagrams, and have been calculated to give a load on the pick-up of approximately 0.25 megohm at middle and high frequencies. If, for example, the load on the pick-up is required to be 0.5 megohm, then the values of the three resistances should be multiplied by 2 and the value of the capacitance should be divided by 2 to give a similar frequency curve.

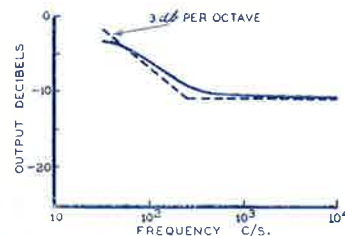

FIGURE 4.

Frequency Characteristic (Solid Line)

when $R_1 = .1775$ megohm
 $R_2 = 75,000$ ohms
 $R_3 = 1$ megohm
 $C = .01 \mu F$.

The broken curve indicates bass boost of 3 db per octave below 250 c/s.

Since some internal bass boosting is obtained with most popular types of pick-ups, it will usually be found that an additional progressive rise of 3 db per octave below 250 c/s will give a reasonably close approach to true reproduction of the original. If a filter providing higher bass boost is used with a popular pick-up, it is likely that the bass would be unduly accentuated.

The components given in Fig. 4 for a rise of 3 db per octave give a characteristic which is within 2 db of the desired characteristic from 50 c/s to the highest frequencies, and it is therefore a very close approach to the ideal. With such a simple filter a very close approach to the ideal is unobtainable for higher degrees of boosting, but the characteristic shown in Fig. 3 is reasonably close to the desired characteristic over the most important range of musical frequencies. The principal shortcoming is the boosting of frequencies in the region of 200 to 300 c/s.

THE USE OF 1.4 VOLT VALVES IN BATTERY/A.C. RECEIVERS

The Radiotron range of 1.4 volt battery valves is suitable for operation in receivers which may be powered by batteries or from the A.C. mains. When operated from batteries the filaments are normally connected in parallel and supplied from a 1.5 volt dry battery through a small dropping resistor. When it is desired to operate the valves from the A.C. mains the filaments may be connected in series or in series parallel, and supplied from the rectified output of a power pack. Radiotron 5Y3-G rectifier is capable of giving a D.C. output current of 125 mA. D.C. which is sufficient for a filament current of .1 A. together with a B supply current not exceeding 25 mA. Most receivers of this nature do not require such a large B supply current and the 5Y3-G is thus amply large for the requirements.

If either type 1Q5-GT or 1D8-GT is used in the power stage the filament current will be .1 A. If other valves in the receiver draw only .05 A. they may be connected in series-parallel or may have resistors shunted across them so that the total current drawn through the whole filament system is .1 A. Since the filament current is rectified and filtered, there

will be no hum arising from this method of operation of the filaments. Certain problems arise in the design of a receiver, however, owing to the fact that some valve filaments are at a higher D.C. potential to earth than others. If two valves are controlled by A.V.C. it may be possible to arrange these in parallel so that normal operation is obtained from both and the A.V.C. voltage may be applied equally to both. In some receivers A.V.C. is applied to one stage only or to one stage much more severely than the other, and in these cases various other arrangements may be adopted.

Since 90 volts maximum is required for the plate circuits of the valves, and from 4.5 to 9 volts bias, the total D.C. voltage delivered by the rectifier and filter under normal full load conditions will be from 94.5 to 99 volts. The series filament dropping resistor will therefore be required to drop the voltage from this value to the voltage required across the filaments in series or in series parallel. This may be checked by placing a voltmeter across the filaments. The voltage should be 1.4 volts per valve filament in series under normal conditions of line voltage and receiver operation.

RADIOTRON 1T5-GT

1.4 VOLT BEAM POWER AMPLIFIER

Radiotron 1T5-GT is a recently announced beam power amplifier with a 1.4 volt filament. The information here given does not indicate the availability of this type. It will be noted that the maximum power output (170 mW.) is less than that of the pentode section of the 1D8-GT (200 mW.), while the cathode current is greater than that of the 1D8-GT (7.9 mA. as compared with 6 mA.).

FILAMENT VOLTAGE (D.C.)*	1.4	Volts
FILAMENT CURRENT	0.050	Ampere
MAXIMUM OVERALL LENGTH	3-5/16"	
MAXIMUM DIAMETER	1-5/16"	
BULB	T-9	
BASE		Intermediate Shell Octal 7-Pin

SINGLE VALVE AMPLIFIER—CLASS A₁

OPERATING CONDITIONS AND CHARACTERISTICS:

Plate Voltage	90 max.	Volts
Screen Voltage	90 max.	Volts
Grid Voltage	-6	Volts
Peak A-F Grid Voltage	6	Volts
Plate Current	6.5	Milliamperes
Screen Current	1.4	Milliamperes
Transconductance	1150	Micromhos
Load Resistance	14000	Ohms
Total Harmonic Distortion	7.5	Per cent.
Max. Signal Power Output	170	Milliwatts

PIN CONNECTIONS.

- | | |
|----------------------|----------------------|
| Pin 1—No Connection. | Pin 5—Grid. |
| Pin 2—Filament +. | Pin 7—Filament —. |
| Pin 3—Plate. | Pin 8—No Connection. |
| Pin 4—Screen. | |

(Pin numbers are according to RMA system.)

OPERATING POSITION.

Vertical or Horizontal—No restrictions.

Socket connection diagram:—G-6X.

*The filament voltage should not exceed 1.54 volt.

RADIOTRON 3Q5-GT

BATTERY BEAM POWER AMPLIFIER

SERIES OR PARALLEL FILAMENTS

Radiotron 3Q5-GT is a beam power amplifier which may be arranged with the filaments either in parallel (1.4 volt 0.1A.) or in series (2.8 volt 0.05A.), the latter arrangement being intended for use in battery/A.C./D.C. receivers. Reference should be made to the article, elsewhere in this issue, regarding battery/A.C. receivers. It should be noted that release of information regarding this valve type does not indicate its availability.

	Series Filament Arrangement*	Parallel Filament Arrangement**	
FILAMENT VOLTAGE (D.C.)	2.8	1.4	Volts
FILAMENT CURRENT	0.05	0.1	
MAXIMUM OVERALL LENGTH		3-5/16"	
MAXIMUM DIAMETER		1-5/16"	
BULB		T-9	
BASE	Intermediate Shell	Octal 7-Pin	

SINGLE-VALVE AMPLIFIER—CLASS A₁

OPERATING CONDITIONS AND CHARACTERISTICS:

	Series Filament Arrangement	Parallel Filament Arrangement	
Filament Voltage	2.8	1.4	Volts
Plate Voltage	90 max.	90 max.	Volts
Screen Voltage	90 max.	90 max.	Volts
Grid Voltage	-4.5	-4.5	Volts
Plate Current	7.5	9.5	Milliamperes
Screen Current	1.0	1.6	Milliamperes
Plate Resistance	110000 approx.	100000 approx.	Ohms
Transconductance	1800	2100	Micromhos
Load Resistance	8000	8000	Ohms
Total Harmonic Distortion	7.5	7.5	Per Cent.
Max. Signal Power Output	250	270	Milliwatts

*Filament voltage applied across the two sections in series between pins No. 2 and No. 7.

**Filament voltage applied across the two sections in parallel between pin No. 8 and pins No. 2 and No. 7 connected together.

PIN CONNECTIONS.

Pin 1—No Connection.
Pin 2—Filament +.
Pin 3—Plate.
Pin 4—Screen.

Pin 5—Grid.
Pin 7—Filament (—for series operation).
Pin 8—Filament Mid-Tap (—for parallel operation).

(Pin numbers are according to RMA system.)

OPERATING POSITION.

Vertical or Horizontal—No restrictions.

Socket Connections: G-7AQ.

VALVE TYPE NUMBERS

SUFFIXES

The following suffixes are in use for identifying valve types. It should be noted that the omission or alteration of the suffix may result in the specification of the wrong valve type.

-G refers to a dome-shaped glass valve having an octal base. Where a metal-envelope valve having identical characteristics is available, its type number will be the same as that of the G type, with the omission of the G. Old-base glass valves have entirely different type numbers from the G valves.

-GT refers to glass valves having small tubular bulbs and octal bases. In cases where both G and GT varieties of one valve type are available they may generally be regarded as electrically interchangeable, although having different overall dimensions.

-LM refers to a metal envelope valve having an Octalox base, fitting the lock-type 8 pin socket.

-LT refers to a glass valve having an Octalox base, fitting the lock-type 8 pin socket.

RADIOTRON 6AG7 VIDEO BEAM POWER TETRODE

Radiotron 6AG7 is a heater-cathode type of metal valve intended for use primarily in the output stage of the video amplifier of television receivers. It may also be used advantageously in television transmitters as a coupling device between video-frequency stages and transmission lines.

The design of the 6AG7 features not only an exceedingly high value of transconductance, but also high plate-current capability. As a result, a large voltage for modulating a Kinescope can be built up across the relatively low load resistance required for coupling the 6AG7 to the Kinescope.

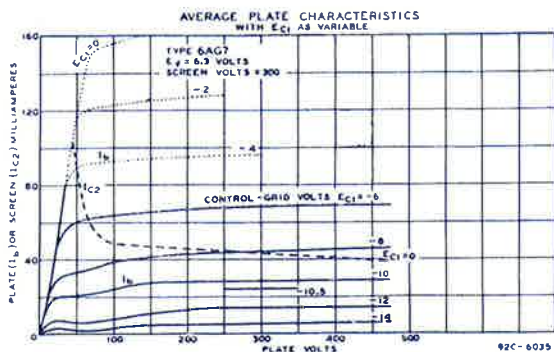

Tentative Characteristics and Ratings

Heater Voltage (A.C. or D.C.)	6.3	Volts
Heater Current	0.65	Ampere
Direct Interelectrode Capacitances:†		
Grid to Plate	0.060 max.	$\mu\mu\text{F.}$
Input	12	$\mu\mu\text{F.}$
Output	12	$\mu\mu\text{F.}$
Grid to Screen	5 approx.	$\mu\mu\text{F.}$
Grid to Cathode and Heater	7 approx.	$\mu\mu\text{F.}$
Heater to Cathode	11 approx.	$\mu\mu\text{F.}$
Maximum Overall Length	3 $\frac{1}{4}$ "	
Maximum Diameter	1 $\frac{5}{16}$ "	
Base	Small Wafer Octal 8-Pin	

Characteristics

Plate Voltage	300	Volts
Screen Voltage	300	Volts
Grid Voltage	-10.5	Volts
Interlead Shield	Connected to ground	
Amplification Factor	770	
Plate Resistance	0.1	Megohm
Transconductance	7700	Micromhos
Plate Current	25	Milliamperes
Screen Current	6.5	Milliamperes

Maximum Ratings and Typical Operating Conditions VIDEO VOLTAGE AMPLIFIER— CLASS A

Plate Voltage	300 max.	Volts
Screen Voltage	300 max.	Volts
Plate Dissipation	8.7 max.	Watts
Screen Input	2 max.	Watts
Typical Operation in 4 Mc/s.		

Bandwidth Amplifier:

Heater Voltage‡	6.3	Volts
Plate-Supply Voltage	250	Volts
Screen Voltage	140	Volts
Grid Voltage††	-2	Volts
Grid Signal-Swing Voltage (Peak to peak)	4	Volts
Plate Current	33	Milliamperes
Screen Current	8.5	Milliamperes
Load Resistance	1700	Ohms
Voltage Output (Peak to peak)	70 approx.	Volts

† With shell connected to cathode.
‡ In circuits where the cathode is not directly connected to the heater, the potential difference between heater and cathode should be kept as low as possible.
†† The D.C. resistance in the grid circuit should not exceed 0.25 megohm.

Installation

The base pins of the 6AG7 fit the standard octal socket, which should be installed to hold the valve preferably in a vertical position with the base either up or down. Horizontal operation is permissible if the socket is positioned so that pins No. 2 and No. 7 are in a vertical plane.

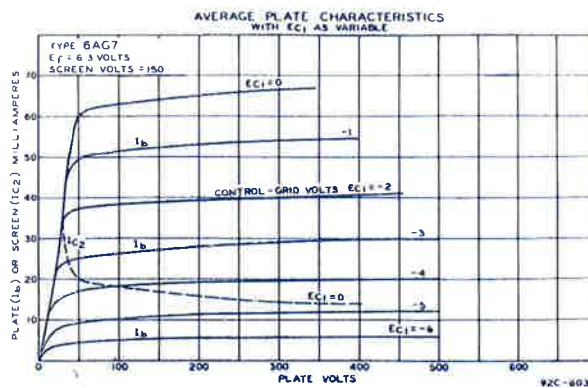
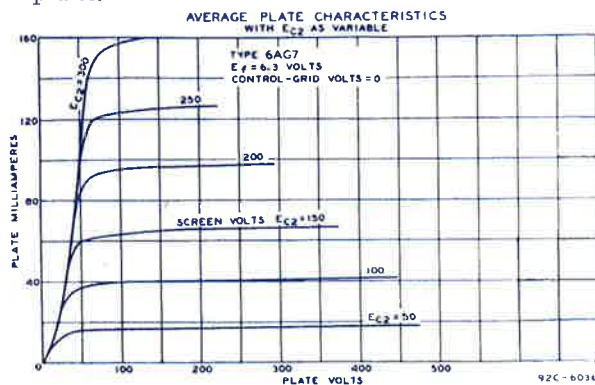

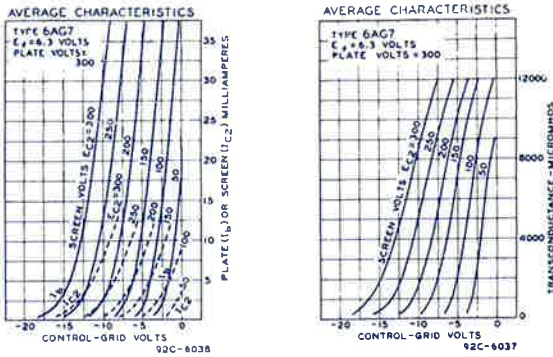

The **heater** of the 6AG7 is designed to operate on either A.C. or D.C. Under any conditions of operation, the heater voltage should not deviate more than plus or minus 10% from the normal value of 6.3 volts.

The **cathode**, when the 6AG7 is operated from a transformer, should be connected through a bias source either to one side or to the electrical mid-point of the heater circuit. In the case of D.C. operation from a 6-volt storage battery, the cathode circuit should be tied through a bias source to the negative battery terminal. The potential difference between heater and cathode should be kept as low as possible.

Control-grid bias may be obtained from a fixed supply, from a cathode resistor, or from a variable voltage supplied for automatic control purposes. In video use, the latter method provides for control of the picture background. With the cathode-resistor bias method, the resistor should not be by-passed if it is desired to have degeneration and freedom from distortion. When, however, no degeneration and maximum signal amplitude are desired, compensation can be provided by utilising filters with equal time constants in the cathode circuit and in the plate circuit.

The **screen** voltage for the 6AG7 operated with fixed bias or cathode-resistor bias, should preferably be obtained through the use of a resistor in series with the high-voltage B-supply. The use of a series screen resistor requires the use of a large by-pass condenser in the screen circuit. The size of the by-pass condenser can be reduced if a suitable compensating filter is used in the plate circuit. When the bias for the 6AG7 is obtained by the automatic background-control method, it is recommended that the screen voltage be obtained from a source of good regulation.

The **interlead shield** is connected within the valve to pin No. 3. This pin should be grounded at the socket to provide a shield between the grid and heater (pin No. 2).

Application

As a **video amplifier**, the 6AG7 is especially designed for use in the final video stage to modulate the Kinescope in a television receiver. In such service, the 6AG7 will provide adequate modulating voltage without frequency discrimination over the wide bandwidth re-

quired for high-definition television reception. The extremely high transconductance and the large plate current of this valve make possible relatively high voltage gain with the low load resistance needed to give uniform output over the wide frequency range. A typical circuit showing suitable constants for a video amplifier is shown below.

TYPICAL VIDEO VOLTAGE AMPLIFIER HAVING BANDWIDTH OF 4 MEGACYCLES

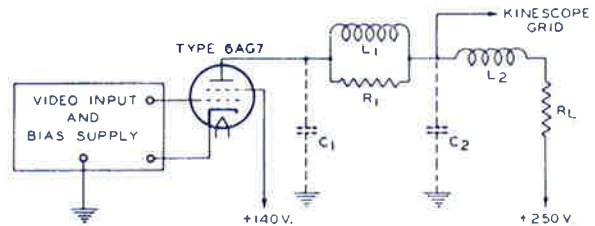

$C_1 = 16 \mu\text{F.} =$ Valve output capacitance + Socket capacitance + Wiring capacitance + Coil capacitance.

$C_2 = 16 \mu\text{F.} =$ Kinescope input capacitance + Socket capacitance + Wiring capacitance + Coil capacitance.

$L_1 = 94 \mu\text{H.}$ Filter inductor.

$L_2 = 47 \mu\text{H.}$ Filter inductor.

$R_1 = 30,000\text{-ohm,}$ non-reactive resistor.

$R_L = 1,700\text{-ohm,}$ 10 watt, non-reactive resistor

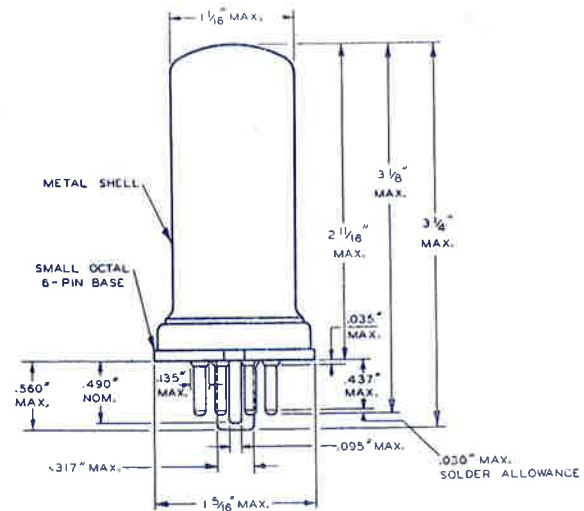

- $G_1 =$ Grid.
- $G_2 =$ Screen.
- $H =$ Heater.
- $K =$ Cathode.
- $P_{BF} =$ Beam-forming plates.
- $S_1 =$ Interlead shield.

STANDARD INTERMEDIATE FREQUENCY

Arrangements have been made by the P.M.G.'s. Department to keep a clear channel between 450 and 460 Kc/s. so that receivers having intermediate frequencies in this range will be free from interference from commercial and other stations. This is in line with the efforts already being made by the F.C.C. in America, and it will therefore be advantageous to standardise upon an intermediate frequency of 455 Kc/s. for superheterodyne receivers. This frequency will be used in all future Radiotron receiver circuits, and it is expected that it will be acceptable to the majority of receiver manufacturers.

DUAL RATINGS FOR TRANSMITTING VALVES

A new system of ratings has been introduced for use with transmitting valves. Instead of one set of maximum ratings for each service, two are given. These ratings are designated as Continuous Commercial Service (CCS) and Intermittent Commercial and Amateur Service (ICAS). The Continuous Commercial ratings are essentially the equivalent of the former

Maximum Ratings, and are based on providing long valve life and maximum reliability in operation. The ratings for Intermittent Commercial and Amateur Service are considerably higher than those for Continuous Commercial Service. They permit the use of much greater power input and provide a relatively large increase in power output. Valve life under these conditions, of course, is reduced. Since there are numerous applications where the design factors of minimum size, light weight, low initial cost and maximum power output are more important than extremely long valve life, the transmitter design engineer may very properly decide that a small valve operated with ICAS ratings meets his requirements better than a larger valve operated with CCS ratings. The new system of dual ratings recognises these diversified design requirements. The choice of valve operating conditions best suited for any particular application should be based on the careful consideration of all factors. These dual ratings have so far been made available for Radiotron valve types 802, 804, 806, 807, 809, 810, 811, 812, 814 and 828, and copies of these new ratings are available on request.

RADIOTRONS 811 & 812

55 WATT TRANSMITTING TRIODES

Radiotrons 811 and 812 are companion valves featuring (1) a "zirconium-coated" plate which has remarkably high heat-dissipating qualities as well as excellent gettering characteristics, and (2) a new, low-loss "micanol" base which has both excellent insulating qualities at high radio frequencies and low hygroscopic characteristics. Both types can be operated at high plate efficiency.

These types are rated in accordance with the new Dual Ratings for Continuous Commercial Service (C.C.S.) and Intermittent Commercial and Amateur Service (I.C.A.S.). These ratings are explained in an article elsewhere in this issue.

TENTATIVE CHARACTERISTICS AND RATINGS.

	Type 811	Type 812		
Filament Voltage	6.3	6.3 V.		
Filament Current	4	4 A.		
Amplification Factor	160	29		
Direct Inter-electrode Capacitances:				
Grid-plate	5.5	5.3 $\mu\mu\text{F}$.		
Grid-filament	5.5	5.3 $\mu\mu\text{F}$.		
Plate-filament	0.6	0.8 $\mu\mu\text{F}$.		
Maximum Diameter	2-7/16"	2-7/16"		
Maximum Length Overall	6-9/16"	6-9/16"		
Base	Medium 4 pin "Micanol" Bayonet			
Rating (see note above)	CCS ICAS	CCS ICAS		
Max. Plate Voltage (plate mod.)	1000	1250	1000	1250 V.
Max. Plate Voltage (other conditions)	1250	1500	1250	1500 V.
Max. Plate Current (plate mod.)	105	125	105	125 mA.
Max. Plate Current (Class B, A.F.)	125	125	125	125 mA.
Max. Plate Current (Class B, R.F.)	60	60	60	60 mA.
Max. Plate Current (Class C)	125	150	125	150 mA.
Max. Plate Dissipation (plate mod.)	27	40	27	40 W.
Max. Plate Dissipation (Class B, A.F. and R.F.)	40	50	40	50 W.
Max. Plate Dissipation (Class C)	40	55	40	55 W.
Typical Output (maximum voltages)	CCS ICAS	CCS ICAS		
Class B, A.F. (2 valves)	175	225	175	225 W.
Class B, R.F. (1 valve)	20	25	20	25 W.
Class C, plate modulated	82	120	82	120 W.
Class C, Telegraphy	115	170	116	170 W.

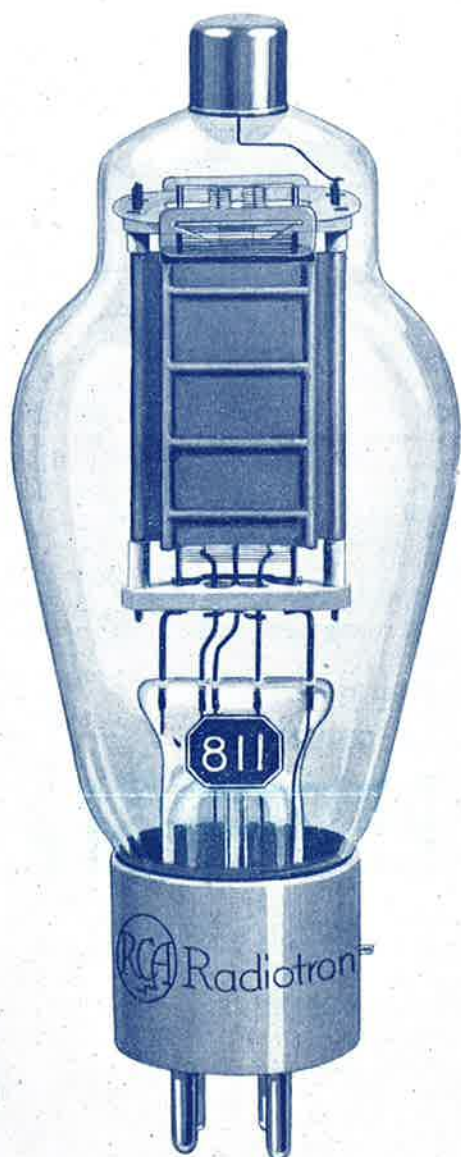

Radiotron 811. For data see previous page.

RADIOTRON 899

WATER COOLED TRANSMITTING

TRIODE

30 KILOWATT DISSIPATION

Radiotron 899 is a water and forced-air cooled transmitting triode having a maximum plate dissipation of 30 KW. under Class C telegraphy conditions. The amplification factor is 32, and the filament current 154 amperes at

14.5 volts. The typical output is 10 KW. under plate modulated conditions, and 35 KW. under Class C telegraphy conditions. Further information is available on request.

RADIOTRON 893

WATER COOLED TRIODE

30 KILOWATT DISSIPATION

Radiotron 893 is a three-electrode, water-cooled, transmitting valve having a maximum plate dissipation of 20 KW. for Class C telegraphy and Class B r-f services. The unique filament construction permits operation from single-phase, three-phase, or six-phase alternating current, as well as from direct current for all classes of service. The 893 may be operated at maximum ratings at frequencies as high as 5 megacycles per second and at reduced plate voltage and input up to 40 Mc/s.

TENTATIVE CHARACTERISTICS AND RATINGS.

Filament:	Multistrand Type
Voltage (per strand)	10 Volts
Current (per terminal) . .	61 Amperes
Current (tot. single phase)	183 Amperes
Average Characteristics (Approx.):	
Grid Voltage	-300 Volts
Amplification Factor	36
Transconductance	16000 Micromhos
Maximum Plate Voltage	
(Class C telegraphy)	20000 Volts
Typical Power Output	
(Class C telegraphy)	50 Kilowatts

CORRECTIONS

It is regretted that some errors occurred in the operating data for Radiotron type 1624 as given in Radiotronics 100, page 57.

Under "As Push-Pull Class AB₂ Audio Amplifier" the maximum ratings given refer to one valve only.

In column 2, under the heading "As R.F. Power Amplifier and Oscillator — Class C Telegraphy" the ratings should read as follows:—

D.C. Plate Voltage	..	600 Volts
D.C. Screen Voltage	..	300 Volts
D.C. Grid Voltage	..	-200 Volts
D.C. Plate Current	..	90 Milliamperes
D.C. Grid Current	..	5 Milliamperes
Plate Input	..	54 Watts
Screen Input	..	3.5 Watts
Plate Dissipation	..	25 Watts

TRANSMITTING BEAM POWER AMPLIFIER

PLATE DISSIPATION 80 WATTS

RADIOTRON 828

Radiotron 828 is a new multi-electrode transmitting valve with a maximum plate dissipation rating of 80 watts (ICAS) for class AB₁ and class C telegraphy services. The 828 contains a suppressor and has beam power features. The valve is designed particularly for use as a class AB₁ modulator and audio-frequency power amplifier; it is also well-suited for use in radio-frequency applications as an r-f power amplifier, frequency multiplier, oscillator, and grid- or plate-modulated amplifier. **Two 828's in class AB₁ service (CCS ratings) are capable of delivering 300 watts of audio power with only 1% distortion.** Because of its high power sensitivity, Radiotron 828 can be operated in r-f services to give full power output with very little driving power and, consequently, with a minimum number of driver stages. Neutralization is unnecessary in adequately shielded circuits. The 828 is ideal for use in transmitters where quick band change without neutralizing adjustments is required. The valve may be operated at maximum ratings at frequencies as high as 30 Mc/s and at reduced ratings up to 75 Mc/s. Radiotron 828 is equipped with the new "MICANOL" base, which has excellent insulating qualities at high radio frequencies together with low moisture-absorption characteristics. The plate connection of the valve is brought out through a separate seal at the top of the bulb to provide high insulation.

TENTATIVE CHARACTERISTICS AND RATINGS.

Filament Voltage (A.C. or D.C.)	10.0	Volts
Filament Current	3.25	Amperes
Transconductance, for plate cur. of 43ma.	4500	Micromhos
Direct Interelectrode Capacitances:		
Grid-Plate (with external shield)	0.05 max.	$\mu\mu\text{F}$
Input	13.5	$\mu\mu\text{F}$
Output	14.5	$\mu\mu\text{F}$
Max. Diameter	2-1/16"	
Max. Length	7-3/4"	
BASE	Medium "MICANOL" 5-Pin	

MAXIMUM CCS AND ICAS RATINGS WITH TYPICAL OPERATING CONDITIONS.

CCS = Continuous Commercial Service
 ICAS = Intermittent Commercial and Amateur Service.

Max. Plate Voltage:—	(CCS)	(ICAS)	
Class AB ₁ , A.F.	1750	2000	Volts
Class B, R.F.	1250	1500	Volts
Grid modulated	1250	1500	Volts
Plate modulated	1000	1250	Volts
Class C	1250	1500	Volts
Typical Power Output (max. plate voltages):—			
Class AB ₁ , A.F. (2 valves)	300	385	Watts
Class B, R.F.	36	41	Watts

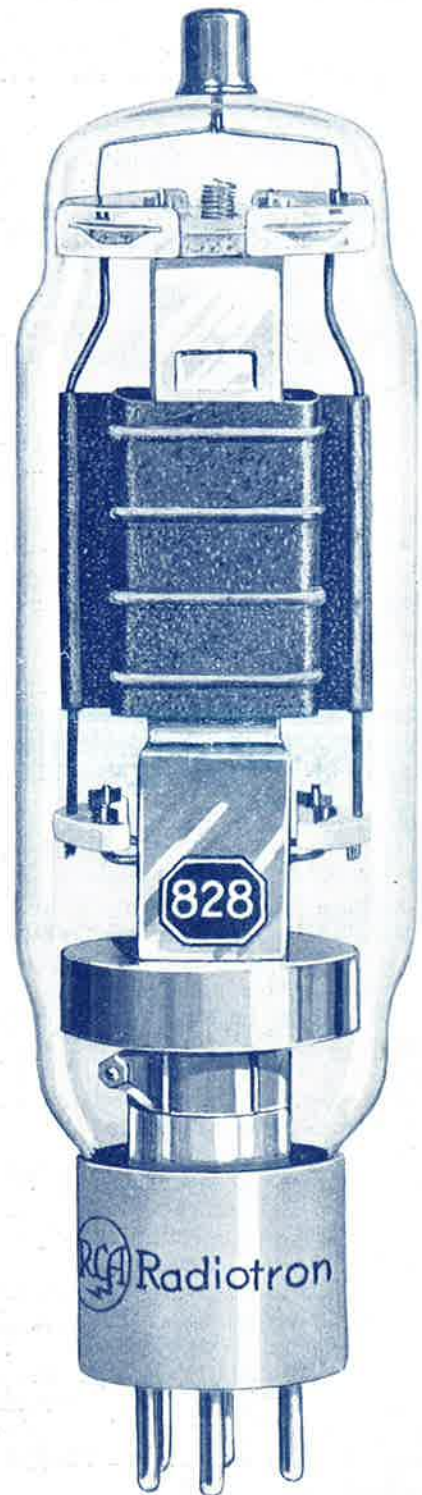

Grid modulated	36	41	Watts
Plate modulated	100	150	Watts
Class C Telegraphy	150	200	Watts

Further data is available on application to the Unified Sales-Engineering Service.

RADIOTRON NEWS

The following valve types have been announced and the information below is given for reference but should not be taken as an intimation of availability.

Radiotron 1T5-GT is a beam power amplifier having a 1.4 volt 0.05 A. filament. See data elsewhere in this issue.

Radiotron 3Q5-GT is a beam power amplifier having a centre-tapped filament for use in battery/A.C./D.C. receivers. The filament may be operated at either 1.4 volts 0.1 A. or 2.8 volts 0.05 A. See data elsewhere in this issue.

Radiotron 6AE5-GT is a low mu triode ($\mu = 4.2$) with a 6.3 volt 0.3 A. heater for use in A.C./D.C. receivers. It is limited to a plate voltage of 95 volts and has a plate current of 7 mA. with -15 volts bias.

Radiotron 6AG7 is a video beam power amplifier for television receivers which was first announced in Radiotronics 99. See data elsewhere in this issue.

Radiotron 6P5-G is a general purpose triode having characteristics identical with those of type 76, on an octal base.

Radiotron 7A6 is a twin diode having a heater operating at 6.3 volts 0.15 A., suitable for use in lock-type 8 pin sockets.

Radiotron 7A7 is a super-control R.F. pentode having a heater operating at 6.3 volts 0.3 A., with a mutual conductance of 2,000 μ mhos., suitable for use in lock-type 8 pin sockets.

Radiotron 7A7-LM is a metal-envelope super-control R.F. pentode with characteristics similar to those of type 7A7, having an Octalox base, which fits the lock-type 8 pin socket.

Radiotron 7A8 is an octode converter having a heater operating at 6.3 volts 0.15 A., suitable for use in lock-type 8 pin sockets.

Radiotron 7AP4 is a high vacuum Kinescope (cathode ray tube designed for black and white reproduction of television pictures) with a 7 inch screen, short bulb and magnetic deflection. See data elsewhere in this issue.

Radiotron 7B7 is a super-control R.F. pentode having a heater operating at 6.3 volts 0.15 A. and a mutual conductance of 1,700 μ mhos., suitable for use in lock-type 8 pin sockets.

Radiotron 7C6 is a duo-diode high-mu triode having a heater operating at 6.3 volts 0.15 A., suitable for use in lock-type 8 pin sockets.

Radiotron 7Y4 is a full-wave indirectly-heated rectifier having a heater operating at 6.3 volts 0.5 A., with a maximum D.C. current of 60 mA., suitable for use in lock-type 8 pin sockets.

Radiotron 12F5-GT is a high-mu triode with characteristics similar to those of type 6F5-GT, but with a 12.6 volt 0.15 A. heater.

Radiotron 12J5-GT is a general purpose triode with characteristics similar to those of type 6J5-GT, but with a 12.6 0.15 A. heater.

Radiotron 12SF5 is a high-mu triode similar to type 6SF5, but with a 12.6 0.15 A. heater.

Radiotron 25AC5-GT is a single high-mu power triode for operation in Class B or with a dynamic-coupled driver, fulfilling a function similar to that of type 6AC5-G but with reduced ratings and output. The heater is rated at 25 volts, 0.3 A.

Radiotron 35A5 is a beam power amplifier having a heater operating at 32 volts 0.15 A. and a maximum output of 1.4 watts, suitable for use in lock-type 8 pin sockets.

Radiotron 35A5-LT is a glass-envelope beam power amplifier with characteristics similar to those of type 35A5, having an Octalox base which fits the lock-type 8 pin socket.

Radiotron 35Z3 is a half-wave rectifier with a heater operating at 32 volts 0.15 A., maximum plate voltage 250 volts R.M.S. and D.C. output 100 mA., and suitable for use in lock-type 8 pin sockets.

Radiotron 35Z3-LT is a glass-envelope half-wave rectifier with characteristics similar to those of type 35Z3, having an Octalox base which fits the lock-type 8 pin socket.

Radiotron 45Z5-GT is a half-wave rectifier with a tapped heater operating at 45 volts 0.15 A., maximum plate voltage 250 volts R.M.S. (with series resistor) and D.C. output 100 mA. without pilot lamp or 60 mA. with pilot lamp and plate to heater tap connection.

Radiotron 811 is a transmitting triode with a "zirconium-coated" plate and low-loss "micanol" base; it has a maximum plate dissipation of 55 watts, and amplification factor 160. See data elsewhere in this issue.

Radiotron 812 is a companion type to the 811, but having an amplification factor of 29. See data elsewhere in this issue.

Radiotron 828 is a transmitting beam power valve having a maximum plate dissipation of 80 watts. See data elsewhere in this issue.

Radiotron 893, a 20 KW. water-cooled transmitting triode, was announced in Radiotronics 99. See data elsewhere in this issue.

Radiotron 899 is a water and forced-air cooled transmitting triode with a maximum plate dissipation of 30 KW. See data elsewhere in this issue.

Radiotron 903, a 9" cathode ray tube with electro-magnetic deflection, has been deleted from the price list. It may be replaced by the 914, which is of the electrostatic deflection type, provided that modifications are made to the deflection system.

Radiotron 911, a 3" cathode ray tube, has been deleted from the price list. It may be replaced in practically all instances by type 3AP1/906P1, which is identical, except that the gun is not entirely free from magnetisation effects.

Radiotron 1898 is a 3" Monoscope (cathode ray tube for demonstrating the principles of television), which may be used as an electrostatic-deflection signal generator providing a picture signal of a young woman's head.