

**THE “AVO”
ELECTRONIC MULTIMETER
TYPE CT38**

WORKING INSTRUCTIONS



AVO LIMITED,
AVOCET HOUSE, 92-96 VAUXHALL BRIDGE ROAD, LONDON, S.W.1
Telephone: VICToria 3404 (12 lines)

2009 COPY HEIN ROS

THE "AVO"
ELECTRONIC MULTIMETER
TYPE CT38

AVOCET HOUSE



PUBLISHED BY
AVO LIMITED,
AVOCET HOUSE, 92-96 VAUXHALL BRIDGE ROAD, LONDON, S.W.1
Telephone: VICToria 3404 (12 lines)

Chapter I

THE AVO ELECTRONIC MULTIMETER (Type CT 38)

INTRODUCTION

LIST OF CONTENTS

	Para.
Ranges of measurement	5
General description	8
General	12

LIST OF ILLUSTRATIONS

	Fig.
Multimeter Type CT38, front view	1
Multimeter Type CT38, block schematic diagram	2

1. This unit is a multi-range electronic measuring instrument designed to eliminate the necessity for the provision of a wide range of separate instruments normally required for the testing and setting-up of radio, radar and electronic equipment. It provides 97 ranges of measurement

covering DC and AC current and voltage, resistance, and power output and has been designed for use under pan-climatic conditions. The accuracy on DC ranges is ± 2 per cent FSD and on AC voltage ranges it is ± 3 per cent FSD measured at 50 c/s.

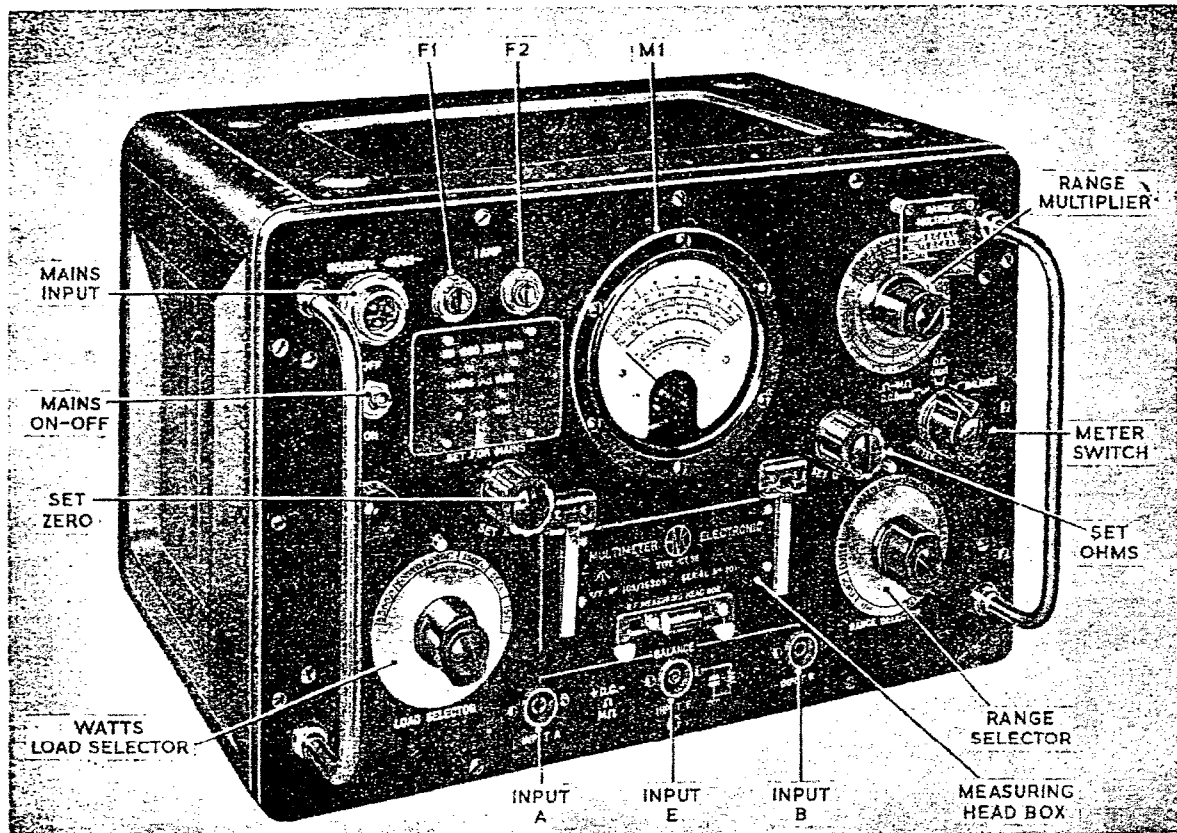

Fig. 1. Multimeter Type CT38, front view

2. The instrument is AC mains operated and may be used on any supply system of from 105 to 125 volts, 45 to 66 c/s and 195 to 255 volts, 45 to 66 c/s. Connection to the mains supply is made by a mains lead and connector which is provided with the instrument.

3. The mechanical construction of the unit has been designed to make servicing as simple as possible. The front panel is of aluminium alloy and bolted to it is a light, braced aluminium alloy framework of rectangular form which carries all the components of the instrument with the exception of those such as switches and the meter which are carried by the front panel. The majority of smaller components are arranged on tag-boards, and the construction is such that these tag-boards

are easily removable for servicing or inspection. All wiring is made up into cable-forms.

4. The overall size is 16 in. wide, 10 in. high and 12½ in. deep when the unit is enclosed in its metal case. For protection in transit, a deep metal lid is fitted over the front of the unit, held in position by four screws, and in this lid are stowed the various leads and connectors of the instrument. These include the mains cable, the RF measuring head unit extension lead, high-voltage multiplier and multi-range shunt resistors, spare fuses, pilot lamp, and millivoltmeter valve.

Ranges of Measurement

5. The overall measurement coverage of the instrument is given in Table 1 below. The figures shown are the full scale deflections for each range.

Table 1

Measurement	Ranges
DC volts	250mV, 1V, 2.5V, 10V, 25V, 100V, 250V. (Input resistance 10 MΩ)
With external multiplier	1,000V, 2,500V, 10,000V, (Input resistance 100 MΩ)
DC current	10 μA, 25 μA, 100 μA, 250 μA, 1 mA, 2.5 mA, 10 mA, 25 mA, 100 mA, 250 mA, 1 amp.
With external multi-range shunt	2.5 amp., 10 amp., 25 amp.
Ohms	0—200Ω Centre scale 15Ω First indication 0.2Ω
	0—20,000Ω Centre scale 1,500Ω First indication 20Ω
	0—2MΩ Centre scale 150,000Ω First indication 2,000Ω
Megohms	0—1,000MΩ Centre scale 25MΩ First indication 1MΩ
AC volts	
With RF measuring head internal and without decade amplifier	1V, 2.5V, 10V, 25V, 100V, 250V.
With external multiplier	1,000V, 2,500V, 10,000V,
With internal amplifier	100mV, 250mV.
With RF measuring head external for use from 25 c/s to 250 Mc/s	1V, 2.5V, 10V, 25V, 100V, 250V. (Input impedance at 1 Mc/s approx. 1.8 MΩ shunted by 7.5 pf).
AC current	10 μA, 25 μA, 100 μA, 250 μA, 1 mA, 2.5 mA, 10 mA, 25 mA, 100 mA, 250 mA, 1 amp.
With external multi-range shunt	2.5 amp., 10 amp., 25 amp.

Table 1—continued

Measurement	Ranges
Power output	
With internal load resistance	
15Ω }	5 mW, 50 mW, 500 mW, 5 watt.
50Ω }	
150Ω }	
600Ω }	50 μW, 500 μW, 5 mW, 50 mW, 500 mW, 5 watt.
2,000Ω }	
5,000Ω }	
Balance input or differential volts	250mV—0—250mV, 1V—0—1V, 2.5V—0—2.5V, 10V—0—10V, 25V—0—25V, 100V—0—100V.

6. On the AC voltage range, with the probe used internally and no decade amplifier in use, the input loading measured at 50 c/s is approximately $2M\Omega$ in parallel with a capacity of 30 pF. The frequency error, when measured from a low resistance source, is negligible from 30 c/s to 2 Mc/s assuming that the input wave form to the instrument is sinusoidal.

7. When using the decade amplifier with the probe internal, on AC voltage ranges the input loading is approximately $0.75 M\Omega$ with a parallel capacity of 60 pF. In this case the frequency error is negligible, when measured from a low

resistance source, from 30 c/s up to 100 kc/s assuming a sinusoidal input.

General Description

8. The basic circuit layout of this instrument is shown in the schematic diagram of fig. 2. It consists essentially of a balanced valve DC millivoltmeter of 250 mV full scale deflection, which is capable of having the polarity of its meter reading reversed. The input to this millivoltmeter is derived from a high-resistance potential divider connected to the DC voltage input giving the voltage ranges, or to a multi-range 250 mV shunt, giving the DC current ranges.

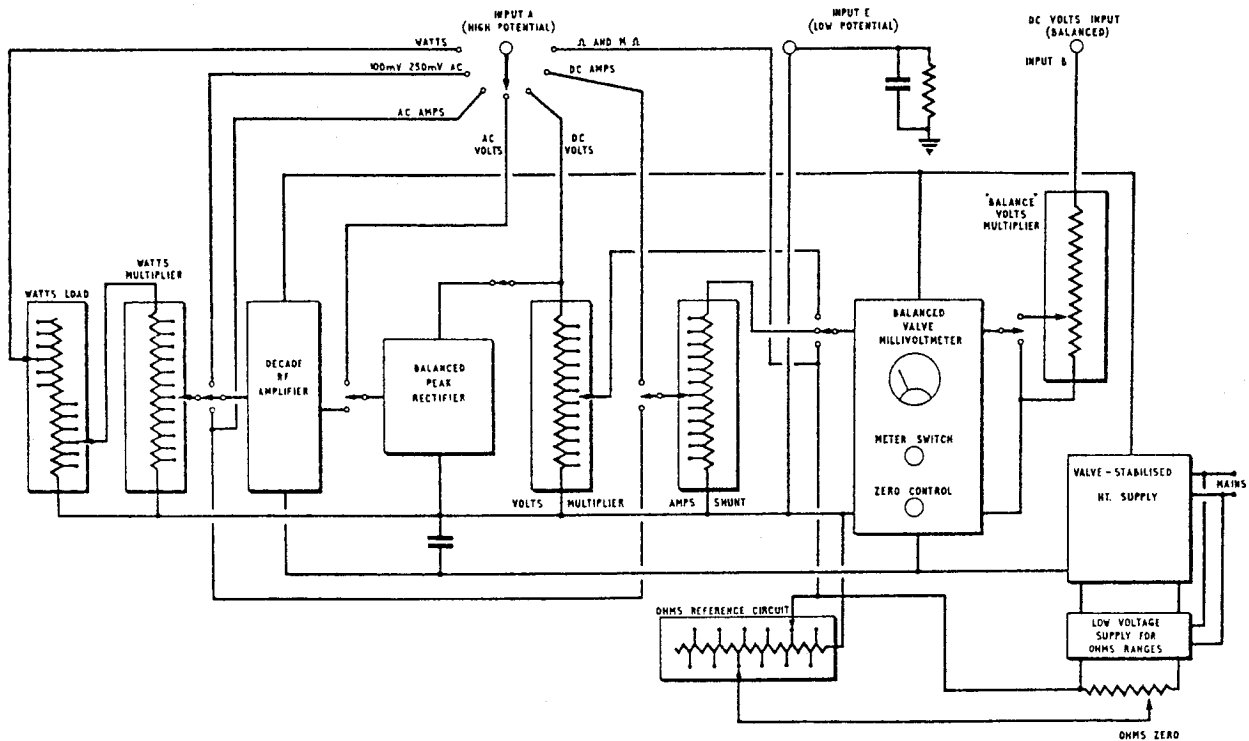

Fig. 2. Multimeter Type CT38, block schematic diagram

9. This is preceded by a compensated peak thermionic rectifier whose output can be connected to the DC volts circuit, giving the AC voltage ranges. The rectifier can be connected, when necessary, to the output of the decade RF amplifier which has a gain of 10. This provides the 100 mV and 250 mV AC ranges. Further, by connecting the amplifier input to the DC 250 mV shunt, AC current ranges at 250 mV voltage drop are obtained.

10. Preceding the decade amplifier is a high-resistance potential divider which sub-divides the output from the tapped watts load resistor, the potential divider thus forming the watts multiplier.

11. The ohms and megohms ranges are measured on the "millivolt drop" principle, the range changing reference resistor connected to the millivoltmeter input being fed by the low voltage output from the power supply.

General

12. On this instrument the switching has been simplified so that once the METER SWITCH has been set it is only necessary to set two controls when setting to any particular range. Thus the RANGE SELECTOR switch selects the type of measurement required (volts, current etc.) whilst the RANGE MULTIPLIER switch selects the range multiplier (x1, x2.5, x10 etc). A third control enables the required internal load to be introduced when power output measurements are required. In addition, when the METER SWITCH is set to the position BALANCE, the meter pointer automatically assumes a centre zero position, enabling either two-terminal (with respect to earth) balanced voltages, or three-terminal differential voltages to be measured.

13. A single linear scale on the meter is used for all DC and AC voltage and current measurements. The meter SET ZERO control serves for all ranges of measurement. The zero having been initially set on a DC current or voltage range, all compensating offsets necessary to overcome errors due to non-linearity on AC ranges of measurement are automatically introduced by the circuit switching and do not necessitate further adjustment of the

zero control. In addition, a single SET OHMS control serves for all ohm and megohm ranges.

14. All DC ranges are available with either positive or negative polarity, with respect to earth, by the appropriate setting of the METER SWITCH.

15. As has been explained in para. 8 to 11, measurement on all ranges is based upon the input to the millivoltmeter measuring stage. This use of an electronic circuit for all ranges affords the following advantages:—

(1) A very high input resistance on DC voltage ranges (on the most sensitive range this is 40 MΩ/volt).

(2) The use of a comparatively robust movement on even the most sensitive DC current range with a virtually constant damping factor and millivolt drop on all current ranges even when the external shunts are used.

(3) A linear scale and wide frequency range together with high input resistance and low input capacitance on AC voltage ranges.

(4) The absence of batteries, which require periodical replacement, on ohm ranges and the facility of very high insulation resistance measurements on the megohm ranges.

(5) The possibility of producing very sensitive (10μA FSD) AC current ranges with virtually linear scale and wide frequency range.

(6) A very wide range (70 dB total) of output power measurement at frequencies extending up to low radio frequencies.

(7) Automatic movement protection against overload or misuse.

(8) A very high degree of operating stability despite mains supply fluctuations, due to the provision of electronic stabilization of the HT supply.

16. The instrument is provided with a thermal delay device which does not bring the meter movement into circuit until approximate thermal stability has been reached in the valves. This eliminates the wide random meter fluctuations usually encountered during the warming-up period. In addition, another switch automatically protects the meter by short-circuiting it when the instrument is switched off.

Chapter 2

THE AVO ELECTRONIC MULTIMETER (Type CT 38)

CIRCUIT DESCRIPTION AND CONSTRUCTIONAL DETAILS

LIST OF CONTENTS

	Para.		Para.
Circuit description		Megohms measuring circuit	24
Introduction	1	AC volts measuring circuit	25
Balanced DC millivoltmeter and power supply circuits	2	AC millivolts measuring circuit	37
DC volts and DC volts (balanced) measuring circuit	17	AC current measuring circuit	41
DC current measuring circuit	19	Watts measuring circuit	43
Ohms measuring circuit	21	Constructional details	46

LIST OF ILLUSTRATIONS

	Fig.		Fig.
Basic DC millivoltmeter circuit	1	DC volts and DC volts (balanced) measuring circuit	10
Basic DC millivoltmeter circuit, balanced input	2	DC current measuring circuit	11
Resistance measurement, simplified diagram	3	Ohms measuring circuit	12
Basic principle, AC measuring circuits	4	Megohms measuring circuit	13
Scale-shape compensation, AC measurements	5	AC volts measuring circuit	14
Multimeter Type CT38, with RF measuring head removed and partially dismantled	6	AC millivolts measuring circuit	15
Multimeter Type CT38, with cover removed	7	AC current measuring circuit	16
Multimeter Type CT38, underside view with cover removed	8	Watts measuring circuit	17
Multimeter Type CT38, side view with cover removed	9	Balanced DC millivoltmeter and associated circuits	18
		Circuit Diagram of the "AVO" Electronic Multimeter (Type C.T.38.)	19

CIRCUIT DESCRIPTION

Introduction

1. The main circuit diagram of the instrument is given in fig. 19, but in order to give a clearer explanation of the operation of the circuit, the main circuit has been divided into a number of simplified diagrams. Fig. 18 shows the circuit of the balanced DC millivoltmeter and its associated power supply circuit and various subsidiary circuits, such as the DC supply for the resistance measuring ranges. The circuits fig. 10 to 17 are the networks which are connected to the input of the millivoltmeter for the respective functions as selected by the RANGE SELECTOR switch.

Balanced DC millivoltmeter and power supply circuits

2. The fundamental function of the valve millivoltmeter used in this circuit is to effect impedance transformation. Thus the external voltage is applied to the input circuit of high impedance, consuming negligible power, and causes deflection of a measuring instrument of comparatively low resistance at the output.

3. In this case the function is performed by valve V4A (fig. 1), the voltage to be measured being applied to its grid via a grid leak of 10 megohms (R35 to R47) and appearing as a change of voltage

across the valve cathode load R63. Owing to the fact that R63 has an ohmic value many times the anode AC resistance of the valve, V4A behaves as a pure cathode follower with 100 per cent negative feedback, thus introducing the following desirable features:—

(1) The system has an amplification factor of unity which is uninfluenced by variations of applied HT voltage or valve characteristics. Initial calibration is therefore not appreciably disturbed by valve deterioration or replacement.

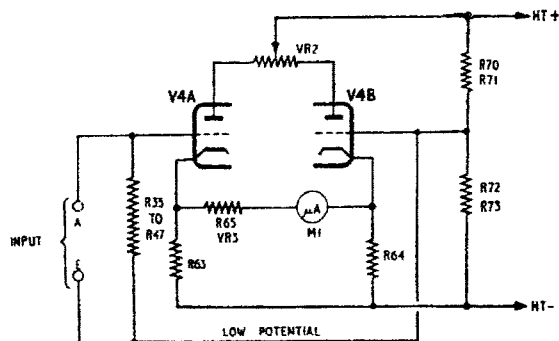

Fig. 1. Basic DC millivoltmeter circuit

(2) The output impedance of the system is low, thus enabling it to be efficiently matched to a robust moving coil movement of comparatively low resistance.

(3) The grid voltage/anode current characteristics is virtually linear.

(4) The effective valve grid current is low, and there is, therefore, negligible spurious voltage developed across the high resistance in the grid circuit.

4. Since the grid voltage to be measured, and hence the voltage developed across R63, may be only a small fraction of a volt, it represents only a very small fraction of the standing DC volts (of the order of 100V) appearing across R63 due to the valve anode current. To ensure that only the voltage to be measured is applied to the movement of the meter it is necessary to "back off" the standing voltage by an equal and opposite DC voltage obtained from another source. The back-ing-off voltage is obtained from the cathode circuit of another cathode-follower valve circuit V4B. This circuit is similar in all respects to the circuit of V4A except that its grid is held at a constant potential.

5. The basic valve millivoltmeter thus takes the form of the simple bridge arrangement shown in fig. 1. The grids of both valves are returned to a point on the HT potential divider a few volts negative to the cathode to give the valves a negative bias, thus ensuring negligible grid current flow and linearity of operation. The potentiometer VR2 serves to vary slightly the anode current flowing in one valve relative to the other so that the standing voltage developed across each cathode resistor is the same. In other words, it serves to adjust the exact balance of the bridge, and thus sets the meter to zero with no input voltage applied to the circuit.

6. A further advantage of the valve bridge circuit is that it overcomes, to a large extent, the effects of an inherent feature of thermionic valves known as contact potential. This takes the form of a negative potential existing at the grid relative to the cathode and behaves as an additional grid bias in series with the applied bias. Unfortunately, the precise magnitude of this potential is not pre-determinable and, being dependent upon the nature of the cathode surface, is liable to vary at random with time. It is of the order of half a volt and can therefore cause a random deflection of the meter of a magnitude comparable with the voltage being measured. It is to a large extent dependent upon cathode temperature and therefore will vary with fluctuations in heater voltage.

7. It is in overcoming this problem that the balanced valve bridge circuit presents its greatest advantage, particularly if the two valve elements of the bridge are of nominally similar cathode construction and fed by a common heater supply. The two valves are thus made the two halves of a double-triode valve in a common envelope; the contact potentials of both halves then tend to be of similar magnitude and to vary similarly during cathode life and with fluctuations in heater voltage. Stability of balance and hence zero stability of the meter calibration, is thus maintained.

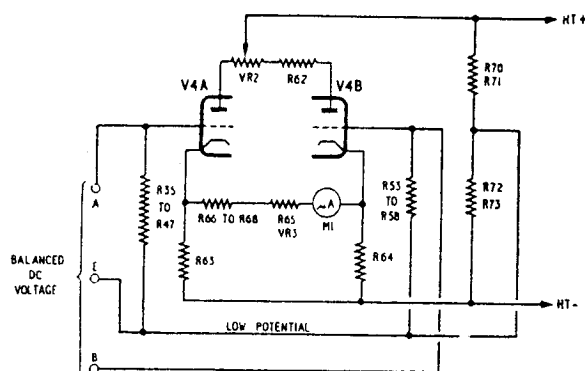

Fig. 2. Basic DC millivoltmeter circuit, balanced input

8. Fig. 2 shows how the basic valve bridge circuit is modified to provide a balanced (differential) DC voltmeter with a centre-zero scale. When balanced DC voltages are being measured V4B is given a grid input circuit similar to V4A, with a result that an input voltage of the same grid-cathode polarity as that applied to V4A is also applied to V4B. This results in a voltage change across R64 in opposition to that across R63, the opposing voltages tending to deflect the meter M1 in opposite directions. The meter zero, however, is now unbalanced by the inclusion of R62 to give a centre-scale deflection with no input to the millivoltmeter. At the same time the movement sensitivity is halved by switching in added series resistors R66, 67, and 68, so that the original DC voltage ranges can appear on either side of centre zero. The circuit changes necessary for this type of operation are made by the operation of the METER SWITCH to the BALANCE position.

9. Although the millivoltmeter calibration is virtually independent of HT variations, it is advantageous for other parts of the circuit to have a stable HT source, and for this purpose a simple valve-stabilized supply is incorporated (fig. 18). This has the additional advantage of providing the necessary smoothing without recourse to large electrolytic condensers or smoothing chokes with their inherent shortcomings.

10. The mains transformer employs special internal screening to avoid the introduction of small spurious AC voltages into the "earthy" side of the circuit due to inter-winding capacitances. These small voltages would otherwise tend to give errors at low readings when the decade amplifier is in circuit.

11. Interposed between the stabilized supply and the DC millivoltmeter is a thermal delay switch V5 which provides a delay of some 90 seconds before the HT voltage is applied to the valves after switching on. This avoids the random fluctuations of the meter pointer during the initial warming-up period, with the desirable result that approximate zero is usually obtained with only a small fluctuation of the meter needle. As a further safety device the switches S1a and S1b are ganged, but in opposition to one another. Thus when S1a is open, so disconnecting the mains supply, S1b protects the meter movement by short-circuiting it. When the mains are switched on, the meter short-circuit is removed.

12. The double-triode valve V4, with its associated cathode load resistors R63 and R64 and the meter movement M1, comprise the basic millivoltmeter, which has a fundamental full-scale deflection of 250 mV.

13. This deflection is normally produced with the grid positive in respect to the low potential line. To accommodate the measurement of negative voltages, and at the same time to allow the negative DC voltage obtained from the peak rectifier circuit on AC measurements to give a forward deflection, a METER SWITCH is provided which reverses the polarity of the meter across the valve bridge circuit. This switch also has a position marked BALANCE, which automatically brings in the circuit alterations necessary for the balanced DC volts measurements. The meter movement in this position assumes the polarity connections of DC NORMAL, that is, INPUT A reads forwards, and INPUT B reads backwards, with positive input voltages.

14. The potentiometer VR3 is a pre-set variable resistor in series with the meter movement to set the initial millivolt drop of the circuit, thus serving as a pre-set calibration control. Stopper circuits R50, C4 and R69, C5 are included in the valve grid circuits to prevent interference by external AC voltages on DC measurements. The resistors R60 and R61 serve to increase the current through the ZERO SET fine control VR1, the zero set coarse control VR2, and the balance offset resistor R62. This compensates for the very low value of anode current through V4A and V4B and so allows reasonably low values of resistance to be used in these positions.

15. The potentiometer network R70, R71, R72, R73 across the HT supply sub-divides this voltage so that the grid return of V4A is brought to a point which makes the valve grid suitably negative with respect to the cathode. The pre-set variable control VR4 is associated with the balanced peak rectifier circuit and serves to pre-set the off-set voltage on the AC ranges, as explained later.

16. The circuit consisting of the 6V—0—6V winding on the mains transformer, the metal rectifier W1, VR6, and R89 provide a low DC voltage source for the resistance measuring ranges. VR6 is the SET OHMS control on the front panel.

DC volts and DC volts (balanced) measuring circuit

(fig. 10)

17. The function of this circuit is to sub-divide the voltage to be measured so that for full-scale deflection on the range selected, 250 mV is applied to the DC millivoltmeter. To ensure that negligible drain is placed on the source to be measured the resistance of this chain is 10 megohms and suitable sub-divisions having factors of $\div 10$ and $\div 4$ give ranges of from 250 mV to 250 volts as shown in fig. 10. The effective input resistance thus varies from 40 megohms/volt on the 250 mV range to 40 K ohms/volt on the 250-volt range. The output from this chain is automatically connected by the range switching to points (1) and (2), the volts to be measured being applied between inputs A and E on the front panel.

18. When the instrument is set to BALANCE a similar resistor chain (R53 to R58) is connected to the grid of the balance valve V4B (via connection (3)), the input now being connected to INPUT B. Two-terminal balanced measurements may thus be made between input sockets A and B, while for three-terminal differential measurements the inputs are connected to input sockets A, E, and B.

DC current measuring circuit (fig. 11)

19. This circuit serves to include between the grid of V4A and the low potential line (via connections (1) and (2) respectively) a resistor across which, for full-scale deflection of the given current range, is developed a potential difference of 250 mV. The desired resistor to give full-scale deflections of from 10 μ A to 1 amp is selected from R23 to R33 respectively by the contact of the RANGE MULTIPLIER switch.

20. It should be noted that although the grid of V4A is electrically connected to the same point as the current input from INPUT A, a separate switch contact serves to pick up the millivolts drop across the resistor and apply it to the valve grid; this precaution is necessary to avoid errors due to the contact resistance of the switch contact which actually carries the current to be measured. On the higher value current ranges the voltage drop across such a contact resistance may be considerable, and cause an appreciable error.

Ohms measuring circuit

21. In the ohms measuring circuit the principle of measurement is that of the "parallel millivolt drop method," which can be explained by reference to the simplified circuit of fig. 3. A potentiometer network R1, R2, sub-divides the voltage from a 2.5V DC source in the ratio 10:1 so that 250 mV, giving full-scale deflection of the meter, is applied to the input of the millivoltmeter circuit. If the resistance to be measured, RX, is connected in parallel with R2, the millivolt drop across R2 will be reduced, with consequent smaller deflection of the meter; the meter can thus be calibrated in terms of RX. For example, if $RX = R2$ the meter deflection will be approximately halved.

22. Alteration of range thus consists of altering R2 to correspond to approximate half-scale deflection of the resistance range in question and altering R1 so that the 10:1 ratio of $R1/R1 + R2$ is maintained.

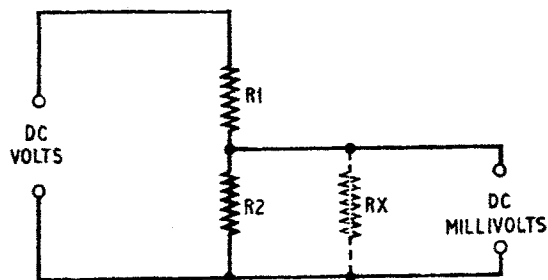

Fig. 3. Resistance measurement, simplified diagram

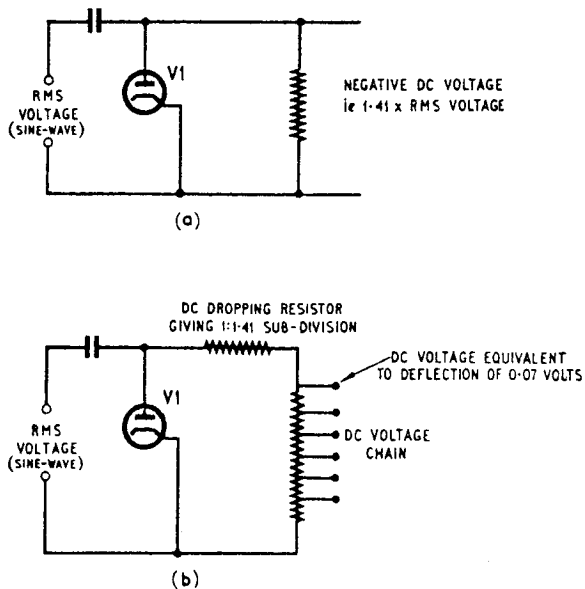

Fig. 4. Basic principle, AC measuring circuits

23. The actual circuit used is shown in fig. 12, from which it will be seen that the range-changing network comprises a number of the resistors already used in the volts measuring circuit, together with additional resistors to make up the required values. The connection (4) which feeds the DC voltage to the network is connected to the slider of the SET OHMS control VR6.

Megohms measuring circuit (fig. 13)

24. This measuring circuit operates on the "series millivolt drop" method and is self explanatory. The 2.5V DC source is applied through connection (4) to a 10:1 sub-dividing network giving a full-scale deflection of the meter when input sockets A and E are short-circuited. The unknown resistance is then substituted for the shorting link across A and E and so placed in series with the top arm of the network (R15, 35 and 36); this reduces the millivolts drop across the bottom arm R37 to 47 and enables the meter to be suitably calibrated in terms of the unknown resistance. R34 serves as a current limiter between switch contact positions.

AC volts measuring circuit

25. The basic principle of this measurement consists in applying the AC voltage to be measured to a low-loaded diode rectifier, with the result that a negative DC voltage appears at the anode of the diode equal to the peak value of the applied voltage. For sinusoidal voltages this is 1.41 times the RMS value ((a) of fig. 4). This negative DC voltage is applied to the normal DC volts range potential divider, a series resistance (R90, R91, R92, R93 of fig. 14) being inserted between the

diode anode and the divider, to reduce all voltages appearing across the divider in the ratio 1:1.41 ((b) of fig. 4).

26. Thus, assuming the form factor of the diode to be such that a sinusoidal RMS voltage of a given value always produces 1.41 times that value in DC voltage, the DC voltage ranges on the potential divider will be direct reading in RMS values. Owing to the fact that the diode form factor on low voltages (up to 10 volts) is such that a slightly lower ratio than 1:1.41 pertains, the top end of the DC voltage chain (up to 10 volts) is duplicated with slightly different sub-dividing ratios (R48 to 51, and R52 of fig. 14); the original tappings on the DC chain (R39 to R47) only come into circuit at the 10 volt point. These additional resistors are proportioned to allow for the average value of form factor expected from the diode, and are such as to allow the low AC voltages to be read on the DC voltage ranges within the specified limits.

27. Normally it is not possible to read low AC voltages on a linear DC voltage scale because the curvature existing at the lower end of the anode voltage/anode current characteristic curve of the diode contracts the voltage reading in a non-linear manner up to about 0.2 or 0.3 volt. In order to overcome this disadvantage and avoid scale complication, an offset DC bias is automatically applied to a suitable point in the diode load chain giving the movement an initial forward deflection of approximately 0.07 volts.

28. Curve A of fig. 5 represents a characteristic obtained from a diode valve over the range 0 to 1V RMS, from which it will be seen that the curvature is reasonably marked up to about 0.2V. This

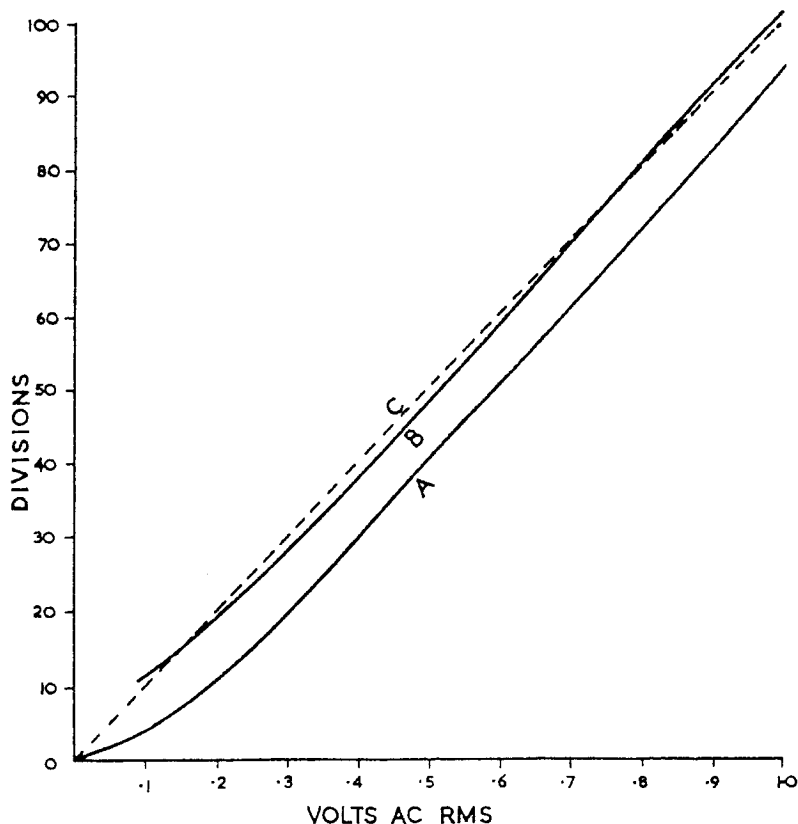

Fig. 5. Scale-shape compensation, AC measurements

characteristic is considerably straighter in the case of the low-loaded peak reading vacuum diode employed than would be the case if a normal mean reading rectifier circuit were used; in the latter case the non-linearity is often extended up to some 0.5V RMS.

29. Curve B shows the same curve offset by a fixed value of 0.07V DC. Comparison of curve B with the ideal linear characteristic curve C shows that, providing no readings are attempted below 0.1V RMS, readings can be made on a linear scale with an accuracy adequate to the requirements of the instrument, and with a discrimination greater at low voltages than would be expected from the low voltage end of a non-linear scale.

30. This offset is a constant factor, the initial meter zero reading being sub-divided in the correct proportion as the voltage tapping is moved down the DC potential divider to increase the voltage range, becoming negligible in relation to the scale for ranges above the 10V range. This system gives the additional advantage that a single linear scale serves for all DC and AC voltages (and as will be seen later, for DC and AC currents as well).

31. A further disadvantage with the thermionic diodes for valve voltmeter applications is the effect of contact potential; this may give a forward DC voltage of anything between 0.4 to 0.8V with no signal applied to the diode. To overcome this problem a double-diode valve V1 (*fig. 14*) is employed, one half of the valve A being connected as the peak reading signal diode, the other half B being inverted and short-circuited to AC by condensers C3 and C10. C3 is a RF by-pass condenser located within the RF measuring head, while C10, in the main instrument, gives low-frequency decoupling.

32. The DC load of diode B consists of R94 and the DC volts potential divider; thus, due to the contact potential of diode B, a DC voltage will exist across the DC potential divider in opposition to that due to the DC contact potential of the signal diode A, since the diode connections are reversed. Provided, as is reasonable to expect, that the contact potentials of both diodes are of a similar order, correct proportioning of the value of R94 to the combined value of R90, 91, 92 and 93 will cause a balancing-out of the contact potentials across the DC volts potential divider.

33. In practice, this balancing contact potential is assisted by a small DC voltage derived from the HT supply via a resistor R95 (*fig. 18*), the value of which is high enough to have negligible shunt effect upon the DC load. The voltage applied by this resistor is variable, within limits, via potentiometer VR4 (*fig. 18*), which thus performs the dual function of enabling the contact potential to be balanced out, and also to permit the setting up of the off-set potential to an effective value of 0.07V.

34. An additional advantage of obtaining this backing-off voltage largely from the contact potential of the second diode is that meter zero variations with change in contact potential due to heater

voltage variations and random causes are to a large extent eliminated. The adjustment is made on the 100 mV range, and holds for all ranges up to 250V RMS.

35. For power and audio frequency measurements, the RF measuring head containing the diode V1 (*fig. 14*) is housed inside the instrument; connection is made to the diode anode by the switching arrangement and the reservoir condenser C1. When used for RF measurements the RF measuring head is connected to the end of an extension lead. To enable part of the diode load to be used as a RF stopper, the load resistance is split, the portion being retained in the RF measuring head being resistor R90.

36. When using the RF head externally, connection is made to the diode anode via terminal C and the reservoir condenser C2. The low potential connection for the voltage being measured is the terminal E of the RF measuring head, and not the socket INPUT E on the front panel of the instrument. Since all connections are made as before through the extension lead, the voltage multiplier switch will function exactly as it does with the RF head used internally.

AC millivolts measuring circuit

37. In order to measure AC millivolts (*fig. 15*) an amplifier circuit V2, V3 having a gain of 10 is introduced between the input terminals A and E on the front panel and the rectifier V1 in the RF measuring head unit. The voltage to be measured is applied from INPUT A via condenser C7 to the grid of the first stage of the amplifier V2. The low potential side of the voltage to be measured (INPUT E) is applied to the earthy side of the amplifier, which is at HT - VE potential as distinct from low potential, by condenser C6.

38. The two stages of the amplifier have a common anode load resistor R79. V2 is a conventional amplifier stage, its output being taken via C1 to the input of the rectifier V1. An output is also taken via C9 and the potential divider R81, R82 to the grid of valve V3, which functions purely as a feedback stage. Further coupling between the two stages occurs by virtue of a common cathode resistor VR5, this resistor being made variable to provide a pre-set gain control. These two coupling paths between V2 and V3 provide negative feedback which is independent of the source resistance connected across INPUT A and E. This feedback has the effect of stabilizing the amplifier gain and linearizing the scale-shape in relation to the magnitude of the input voltage.

39. The biasing voltage for each stage is provided separately by R99 and R100 respectively; separate biasing resistors are used in order that the two valves work with approximately equal anode currents. The resistors R75 to R78 are provided as RF grid and anode stoppers.

40. Changing of the range from 100 mV to 250 mV is accomplished by changing the DC millivoltmeter input tap on the DC voltage chain from the 1V tapping point to the 2.5V tapping point.

The zero-offsets which will occur on these AC millivolts ranges are similar to those on the corresponding AC volts ranges used, with the exception of the fact that the offsets on the millivolts ranges will contain a small amount of spurious 50 c/s voltage which will be additive to the reading. This spurious voltage is reduced to negligible proportions by the somewhat complicated system of screening provided in the mains transformer (para. 10).

AC current measuring circuit

41. The circuit which is made by the switching arrangements for the measurement of AC current is shown in fig. 16. The same shunt resistors R23 to R33 and the same switching arrangements are used as are used for the DC current measuring circuit.

42. In any position of the RANGE SELECTOR switch a current equivalent to the full-scale deflection of the particular range will give a voltage drop of 250 mV, which is applied via C7 to the grid of the amplifier stage V2. As already stated, the amplifier comprising V2 and V3 gives an overall gain of 10, so that for full-scale deflection 2.5V will be applied to the input of the rectifier V1 and will appear across the diode load. The input to the DC millivoltmeter, via connection (1), is connected to the 2.5V tapping point on this chain.

Watts measuring circuit (fig. 17)

43. For measurements on the power ranges of the instrument the watts measuring circuit, consisting of a bank of load resistors (R3-4, R5-6, R7-8, R9-10, R11-12, R13-14) and a multiplier chain R17 to 22, is switched into circuit between the input terminals A and E and the input of the amplifier stages (fig. 17). The DC millivoltmeter is connected to a tapping point of 1.73 volts on the AC volts chain giving the overall amplifier/AC voltmeter circuit a sensitivity of 173 mV FSD.

44. The power to be measured will give rise to a voltage V across one of the six load resistances (such as R3-R4) depending upon the position of the WATTS LOAD selector switch. If W is the full-scale wattage on any particular range, and R the value of the load resistance, then when the voltage V is such that $\frac{V^2}{R} = W$ then full-scale deflection of meter M1 will occur. Since, however, for full-scale deflection on any range it is required that the voltage developed across the multiplier chain R17 to 22 is constant in each of the six positions of the WATTS LOAD switch, the load resistance R is in each case split into two resistors; the values of these two resistors are so proportioned that at the tapping point between them the input voltage V is converted to a constant voltage on all six values of load resistance.

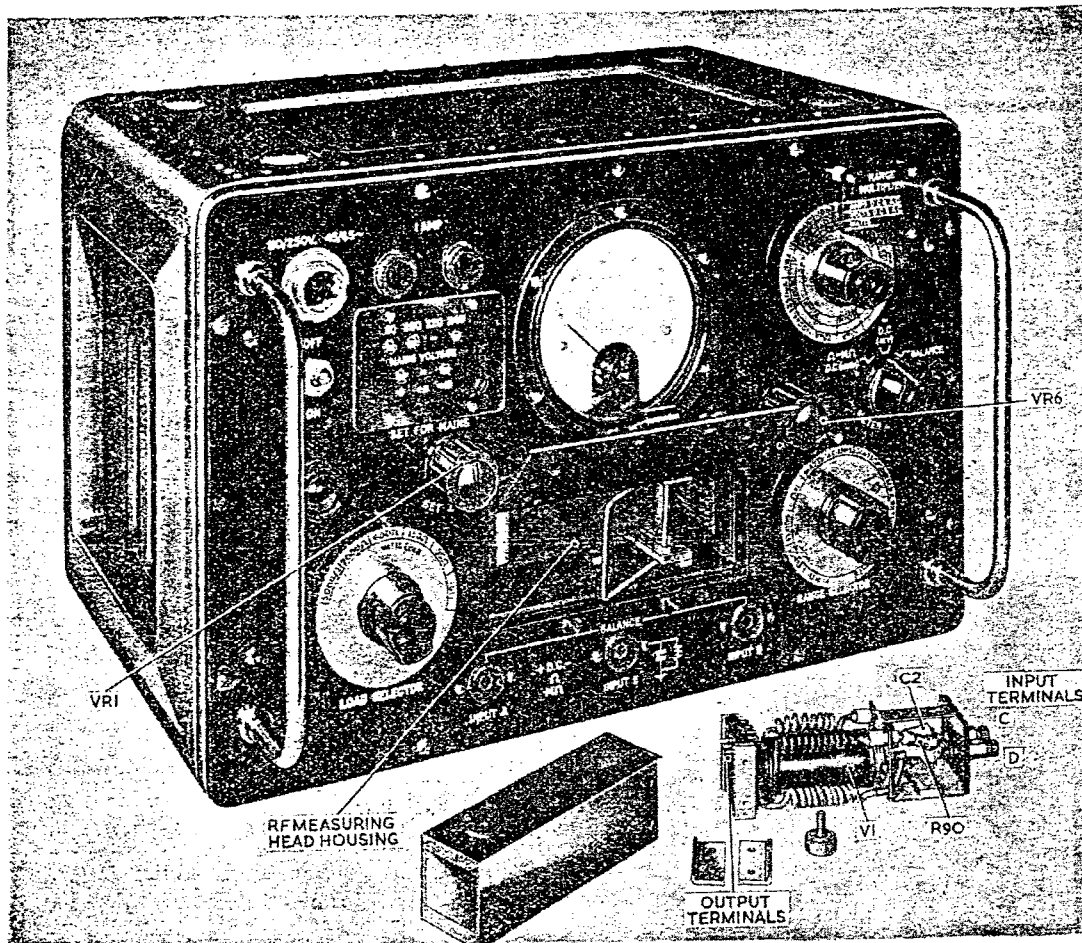

Fig. 6. Multimeter Type CT38, with RF measuring head removed and partially dismantled

45. This constant voltage applied to the multiplier chain R17 to 22 is, in each range position, tapped off and applied to the grid of V2 via C7. The values of the chain are selected so that for full-scale deflection at each position of the range switch the input voltage to V2 is 173 millivolts. To avoid overloading of the decade amplifier, ranges up to 5 milliwatts are short-circuited for load values of 15, 50 and 150 ohms.

CONSTRUCTIONAL DETAILS

46. The general physical construction of the instrument can be clearly seen from the illustrations of fig. 6 to fig. 9. The aluminium-alloy framework upon which most of the components are carried is shown, together with the cross-pieces which strengthen and brace the assembly. Fig. 9 illustrates the method of bolting this braced rectangular framework to the aluminium-alloy front panel, two bolts holding each of the four angle-pieces of the framework. One of these two bolts, in each case, is one of the threaded ends of the two handles on the front panel and serves to hold these handles in position, as well as bolting the main framework.

47. Fig. 7 and 8 also show some of the components carried on the rear of the front panel itself.

These include the meter, mains fuses, switch and indicator light, input socket, and the three measurement input sockets; fig. 9 shows the arrangement used to couple the front panel controls to their respective components inside the unit.

48. Fig. 6 shows the instrument with its aluminium-alloy case in position. The case, which is fitted with a handle at each end, is held in position by eight bolts passing through the front panel. A small metal bracket fitted on the inside of the rear of the case operates the mains safety microswitch (S1a) when the unit is properly situated in the case. In transit the equipment is protected by a deep aluminium-alloy lid which bolts over the front panel. The depth of this lid is used for the storage of the accessories of the instrument, such as spare fuses, lamp and millivoltmeter valve, external shunt and multiplier resistors, measuring leads, the RF measuring head extension lead, and the mains lead.

49. In fig. 6 the RF measuring head unit is shown removed from its housing box on the front panel and partially dismantled to show its construction. The double-diode valve V1 is mounted on a small metal platform spaced from the insulated panel carrying the two input terminals c and d

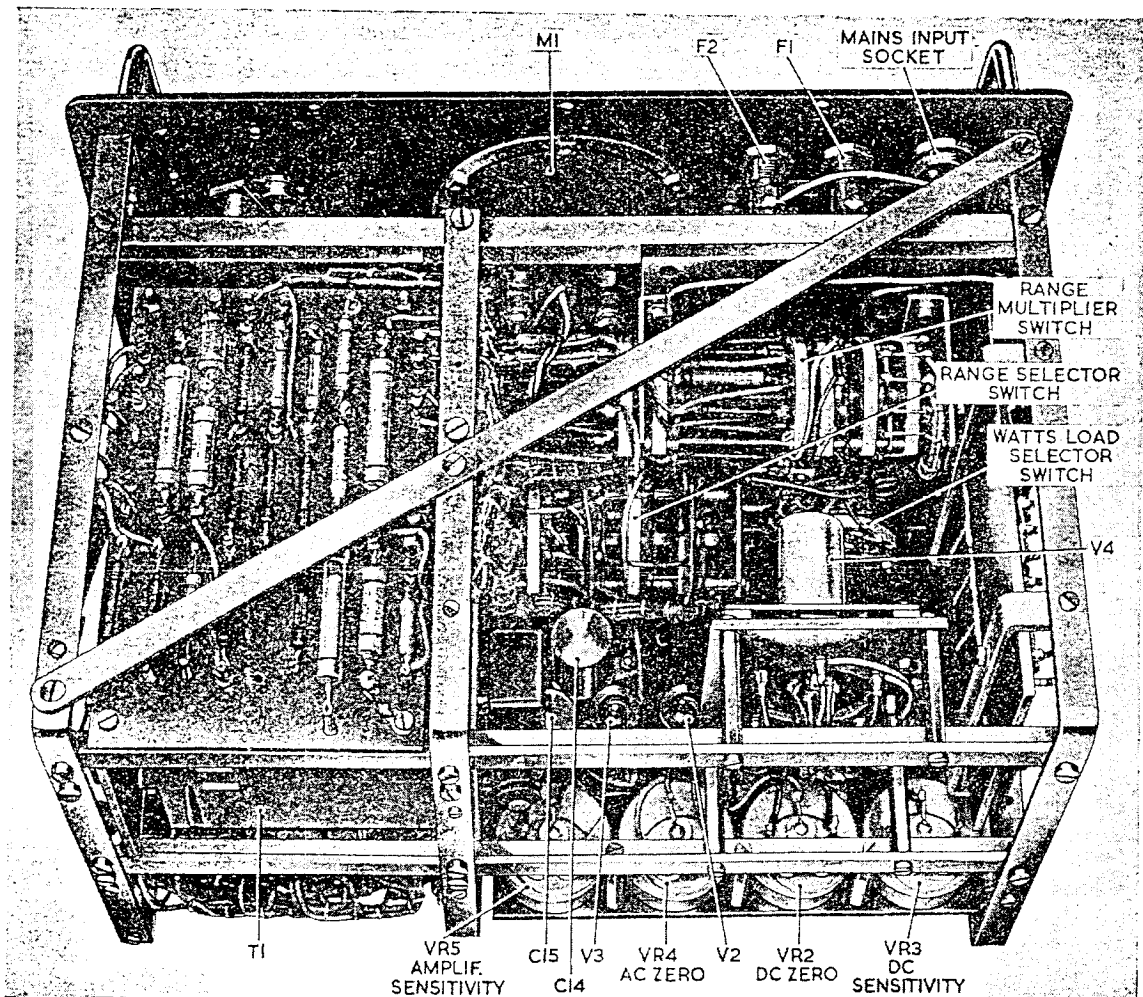

Fig. 7. Multimeter Type CT38, with cover removed

by distance pieces; this arrangement allows the connections from c and d to the V1 valve-base to be kept very short. The input condenser C2 and the resistor R90 are shown connected to the c and D terminals respectively.

50. The two DC output leads pass through the valve mounting platform by insulated feed-through terminals and are then connected to the output terminals on the base of the unit. The third lead shown in the illustration, also connected via a terminal on the base, is the heater feed line to V1.

51. The insulated base has two metal side-pieces which carry tapped holes for the fixing screws which hold the metal cover of the unit in position. The output terminals take the form of spring-loaded short metal pins, and when the unit is carried internally in the instrument, these pins engage in the metal ramps of the connector shown in fig. 6 at the extreme right-hand side of the unit mounting box. Spring-loading of the pins ensures good contact with the metal ramps of the connector.

52. To the left of this connector is shown a device which provides easy removal of the RF unit from its box. One further connector is included, which can just be seen at the extreme left-hand side of the box. This serves to short-circuit contacts C and D when the RF measuring head unit is in position and connects them, in series with C1, to the input terminal A on the front panel.

53. Almost all the small components of the instrument, such as condensers and resistors, are carried on tagboards of insulated material which are bolted to the main framework of the unit. Wherever possible the components associated with any particular

part of the circuit are mounted on the same tagboard and situated near the valve or valves to which they are connected. Thus, for example, the amps. shunt resistors are grouped on one board and the balanced millivoltmeter components on another. The construction is such that the individual tagboards are easily detachable from the main framework, the cable-form being so designed as to enable the tagboards to be moved sufficiently to expose the connections at the rear. This makes it possible to reach any part of the instrument without difficulty. It will be noted that certain connections are made via PTFE (polytetrafluorethylene) feed-through seals mounted in the Bakelite boards. These are to maintain the extremely high insulation resistance required.

54. Three of the main switches can be seen in fig. 7, although two of them are partially hidden by the tagboard on the left of the illustration and the other by the valve V4. The one nearest to the front panel is the RANGE MULTIPLIER switch, and lying parallel to it is the RANGE SELECTOR switch. The WATTS LOAD selector switch lies below the former. The four potentiometers VR2, 3, 4 and 5 are the pre-set controls for the setting-up of various voltages (indicated by the annotations of fig. 7); since it is essential that these voltage settings shall remain stable over a considerable period of time, the potentiometers are hermetically sealed so that their resistance values are not affected by external changes such as that of ambient temperature.

55. Two tagboards are shown in this illustration. That on the left, the circuit completion board, carries the miscellaneous supplementary resistors and condensers of the instrument associated with the various circuits. The board on the extreme right carries the resistors of the amps. shunt chain.

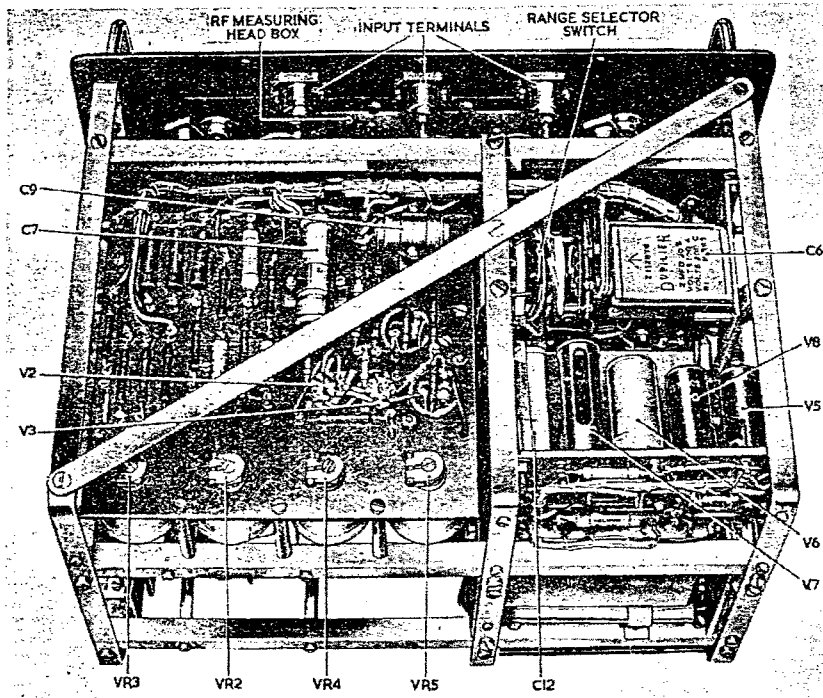

Fig. 8. Multimeter Type CT38, underside view with cover removed

56. The millivoltmeter circuit operates as a balanced bridge arrangement, and it has been found that movement of the electrodes of either of the two triode sections of the millivoltmeter valve V4 is sufficient to cause changes large enough to destroy the balance conditions. To prevent movement of these electrodes due to mechanical vibration the millivoltmeter valve is mounted upon a specially designed mounting which can be seen in fig. 7.

57. This mounting, which is carried by four spacing pillars, takes the form of a square piece of insulating material with a large circular hole in the centre. The metal platform carrying the valve-base itself is attached by two strips of flexible material to two metal

strips which are themselves mounted on the main platform of insulating material. The valve-base is thus isolated by the flexible strips from mechanical vibration. The circular hole in the main platform gives access to the underside of the valve-base so that the electrical connections can be made.

58. A set of terminals is provided on the underside of the main platform, and the valve-base contacts are connected to these by thin strips of flexible metal; this permits the valve mounting platform to move freely while still maintaining the electrical connections. The leads from the terminals on the main platform to the external circuit are carried in a short cable-form terminated in a Unitor plug, the corresponding socket being placed on the tag-board carrying V2 and V3, etc. This arrangement makes it possible to remove the entire millivoltmeter valve mounting assembly by removing the Unitor plug and the four bolts holding the spacing pillars to the angle-pieces shown at the bottom of fig. 7.

59. Fig. 8 shows the underside view of the unit. The tagboard on the left carries the components of two parts of the circuit. Those components to the left of C7 are the millivoltmeter components, whilst those on the right are associated with the two-stage decade RF amplifier. The bases of the two RF amplifier valves V2 and V3 can also be seen.

60. The small platform on the bottom right-hand side of fig. 8 carries the rectifier V7, the stabilizer valve V6, neon stabilizer V8, and the thermal delay switch V5. On the underside of the platform are the components of the rectifier and stabilizer circuits.

61. Fig. 9 shows the coupling arrangements between the panel controls and their associated

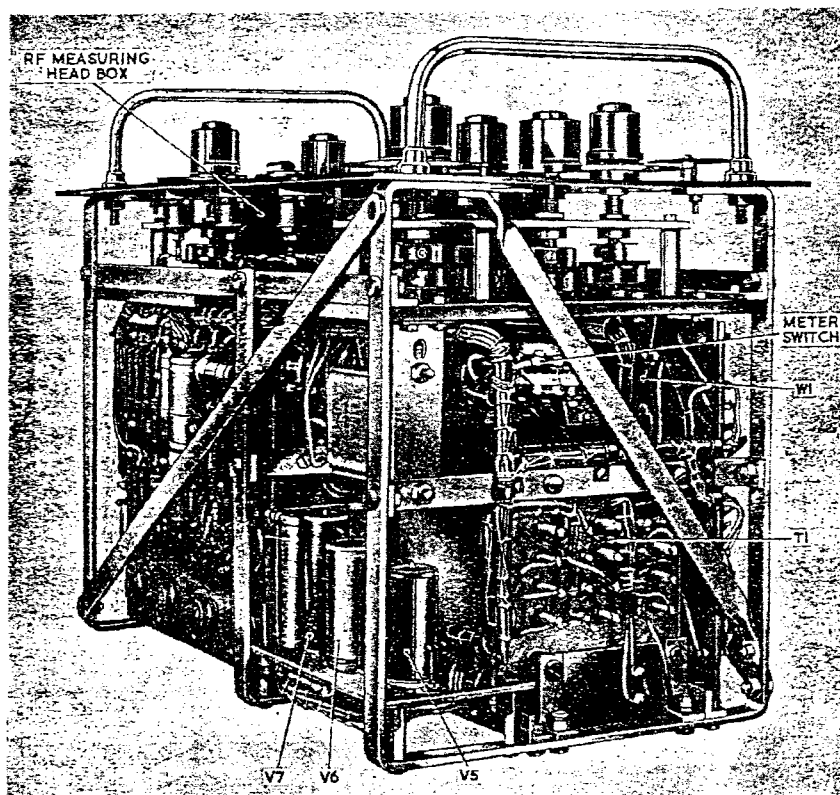

Fig. 9. Multimeter Type CT38, side view with cover removed

components. Those components which are mounted with their spindles at right angles to the front panel, such as the meter switch in this illustration, are connected by a flexible coupling with a bush bearer. The RANGE MULTIPLIER and RANGE SELECTOR switches, mounted parallel to the front panel, are connected by a similar flexible coupling arrangement with bevel gears connecting the control shaft to the switch spindle.

62. The RF measuring head box is just visible in this illustration. The connections from the two connectors in the box are brought through to tag-strips mounted on the ends of the box, where the connections to the external circuit are made. Also mounted on the box itself are the condenser C1 and resistor R97. Situated on the bottom of the instrument framework below the mains transformer (not shown in these illustrations) is the MODIFICATIONS panel.

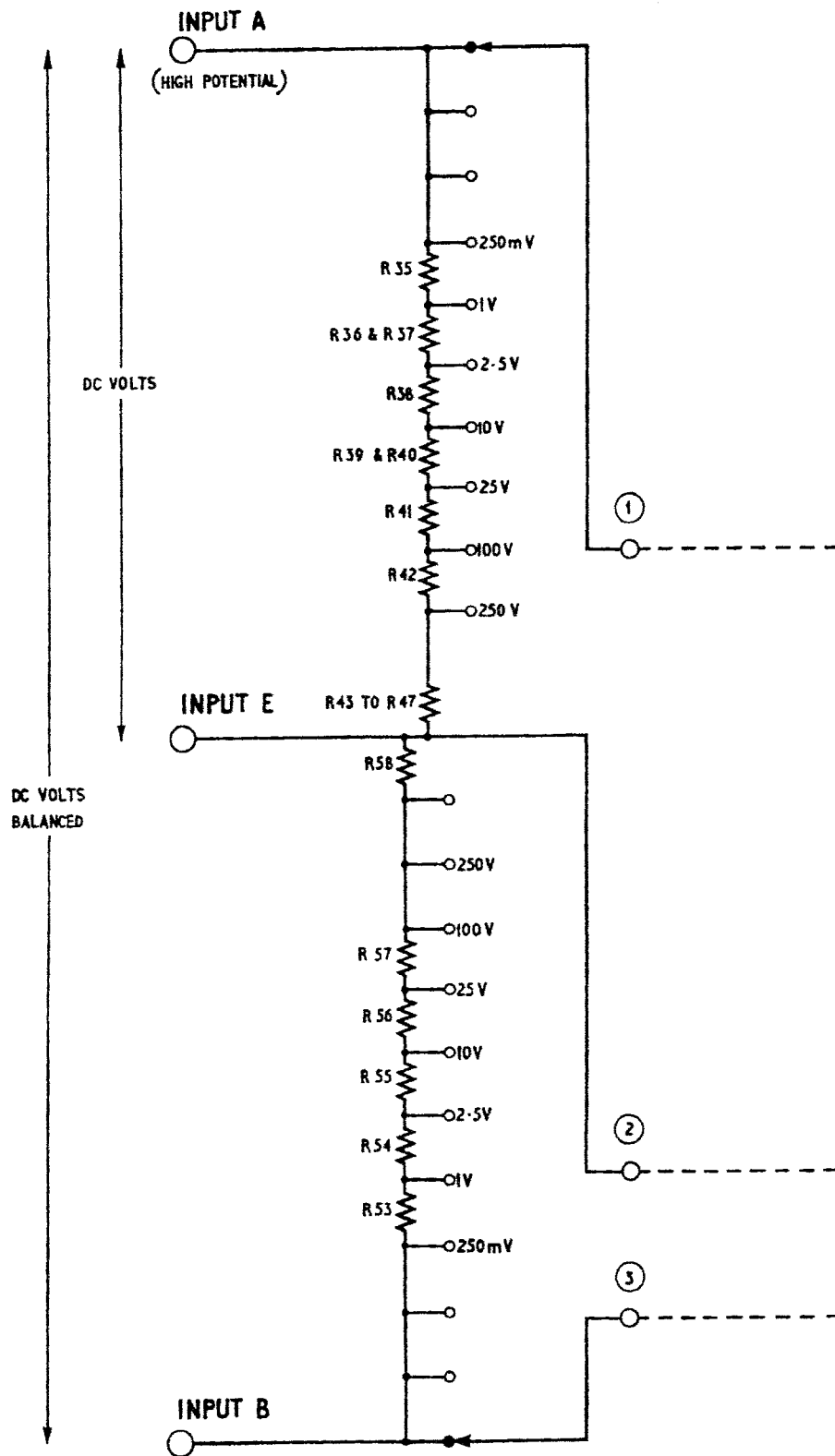

Fig.10. DC volts and DC volts (balanced) measuring circuit

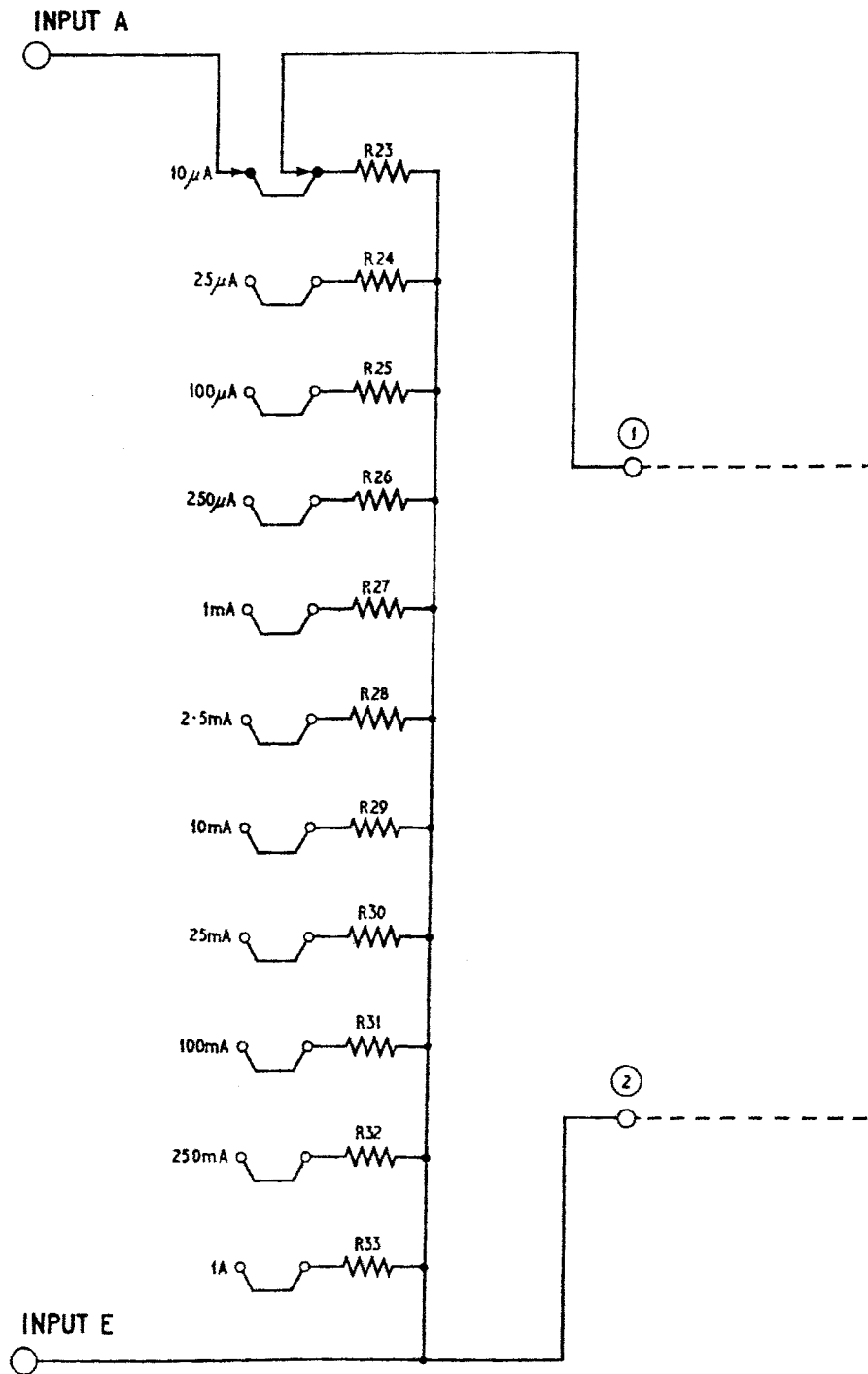

Fig.II. DC current measuring circuit

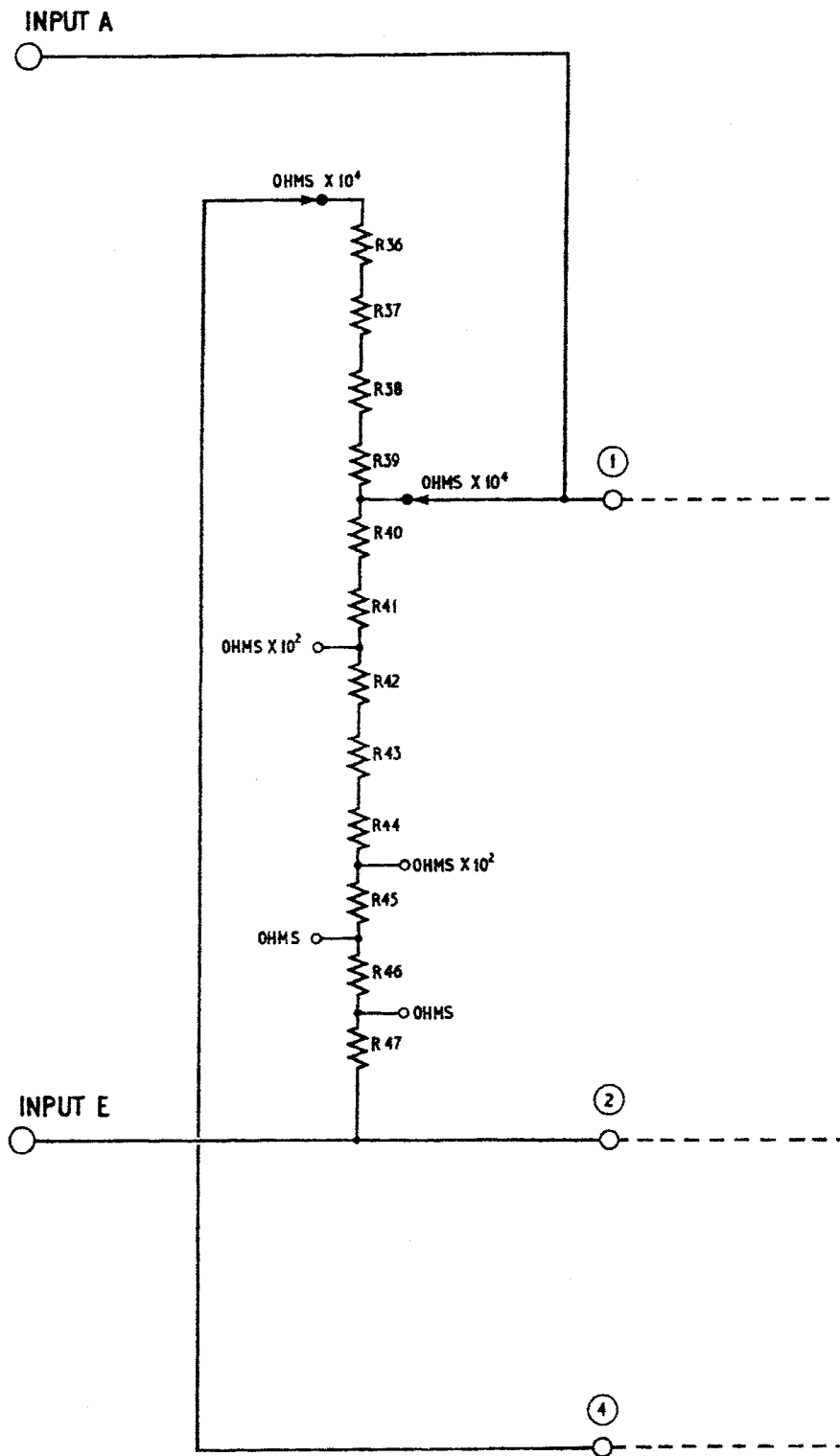

Fig.12.Ohms measuring circuit

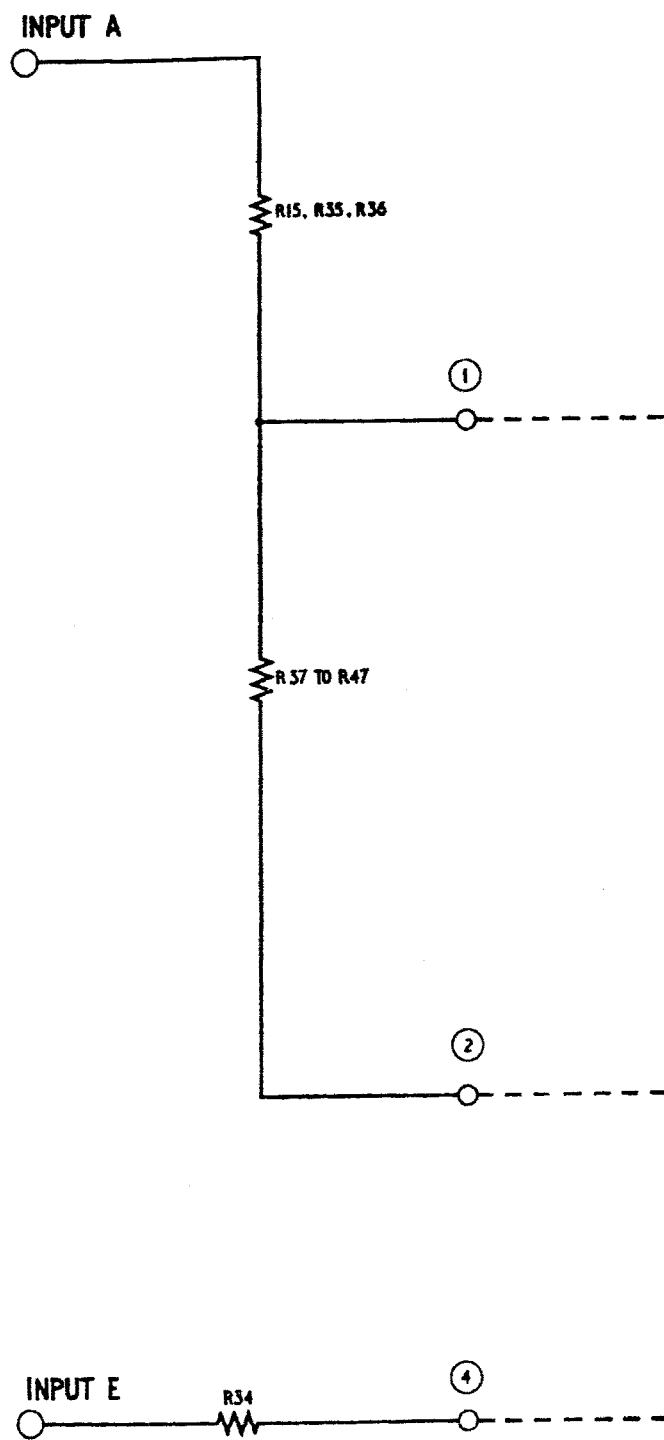

Fig.13.Megohms measuring circuit

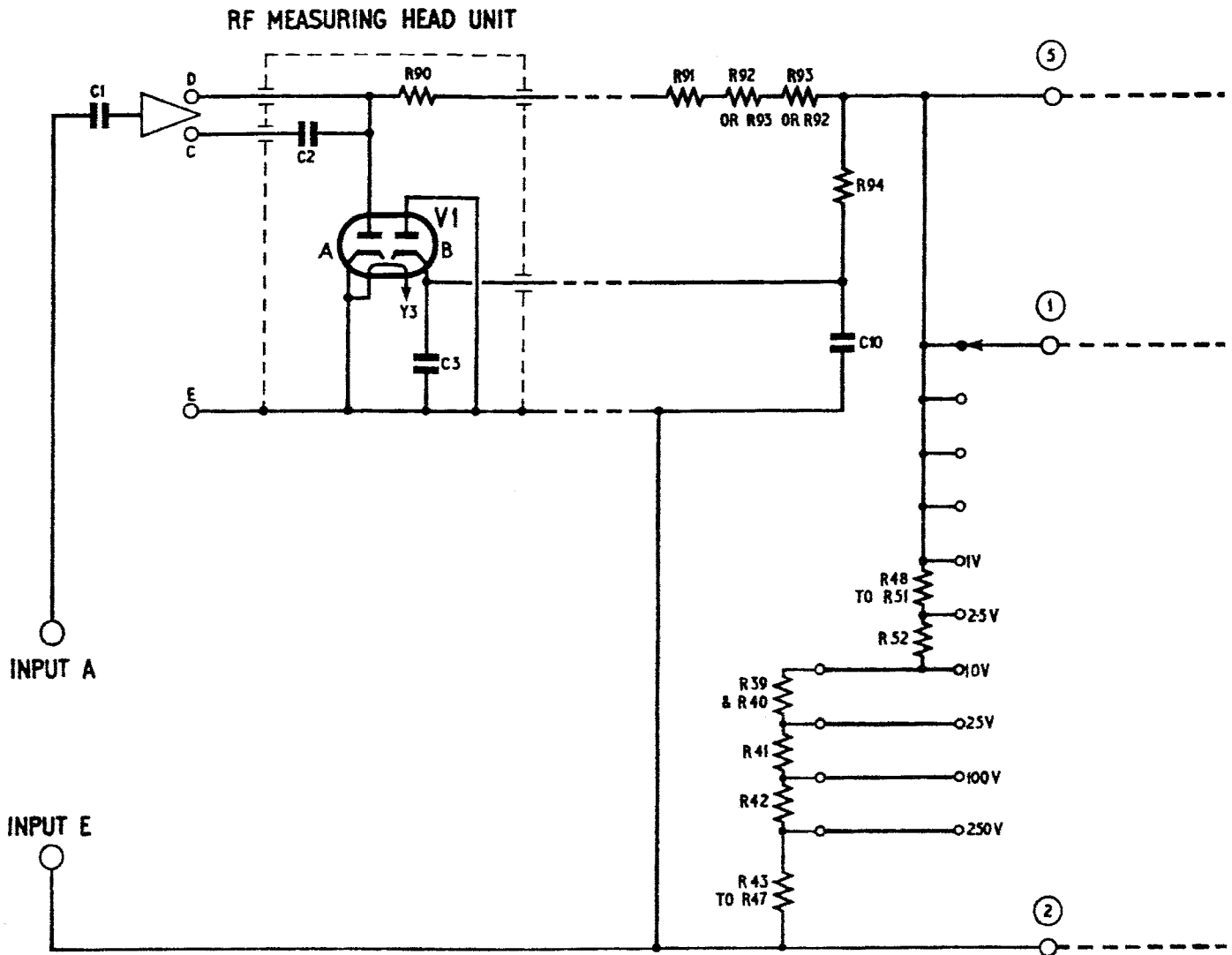

Fig.14. AC volts measuring circuit

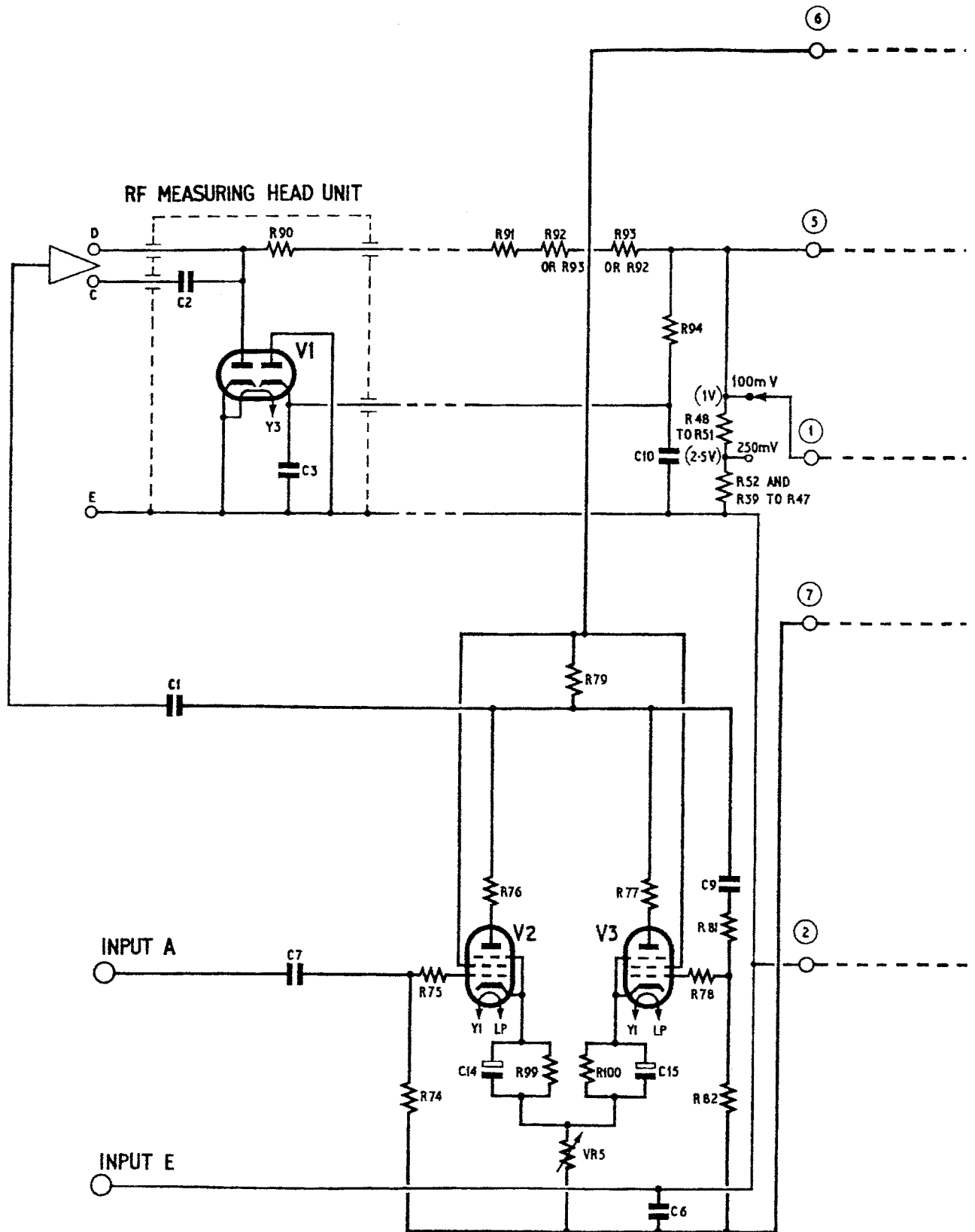

Fig.15. AC millivolts measuring circuit

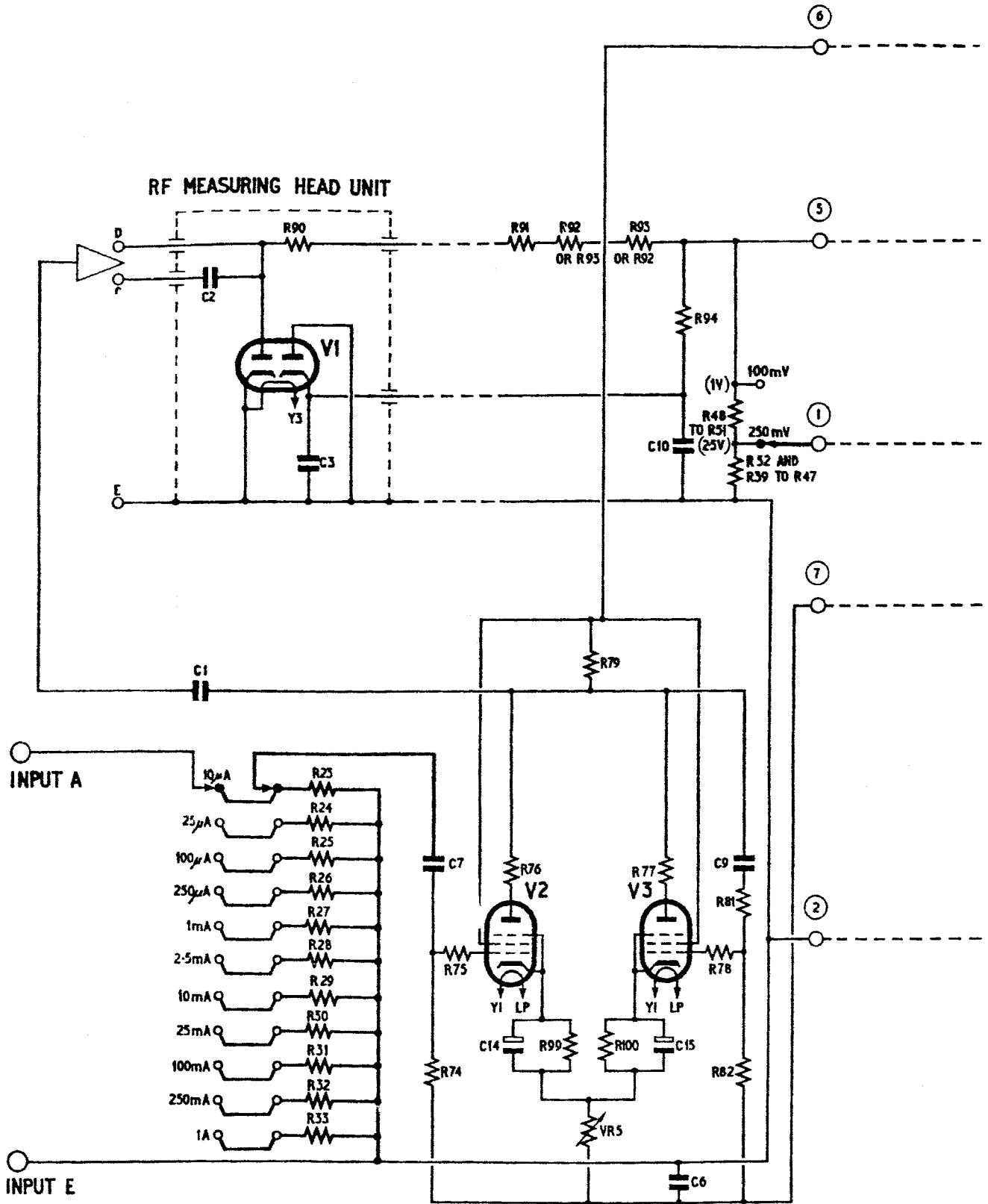

Fig.16. AC current measuring circuit

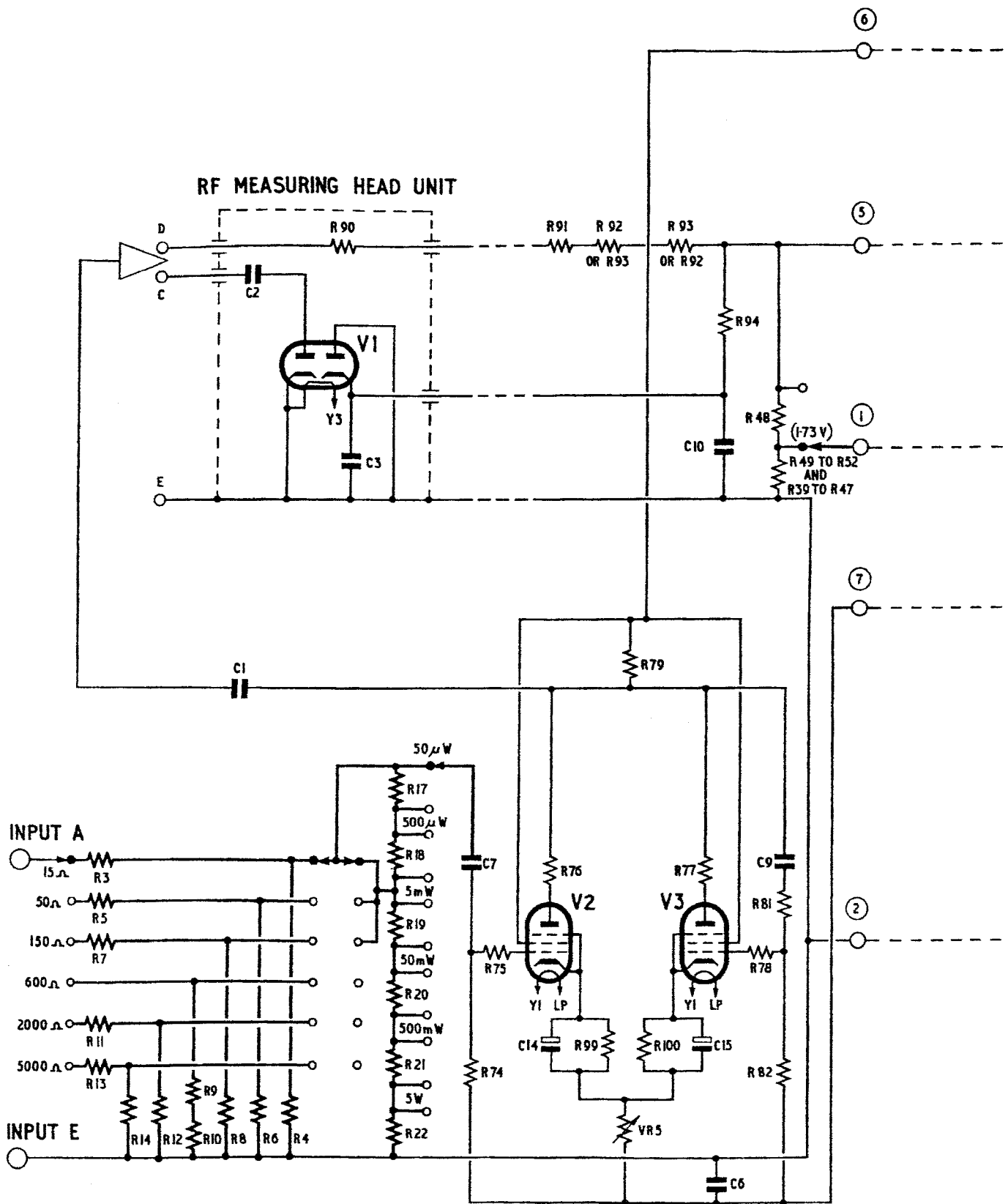

Fig.17.Watts measuring circuit

Chapter 3

THE AVO ELECTRONIC MULTIMETER (Type CT 38)

LIST OF CONTENTS

	Para.		Para.
<i>Introduction</i>	1	<i>High DC voltages and the use of the meter switch</i> ...	21
<i>Controls</i>	2	<i>AC volts ranges</i>	26
<i>Preset controls</i>	3	<i>AC millivolts (250 mV range)</i>	37
<i>Accessories</i>	5	<i>AC millivolts (100 mV range)</i>	41
<i>Preparing for use</i>	6	<i>AC current ranges</i>	43
<i>Precautions to be observed during use</i>	14	<i>AC and DC current measurements 1A to 25A</i>	44
<i>DC volts ranges</i>	15	<i>Watts measuring ranges</i>	45
<i>DC high-voltage ranges</i>	19	<i>Ohms and megohms ranges</i>	47

LIST OF TABLES

	Table
<i>Position of controls for given measurements</i>	1

LIST OF ILLUSTRATIONS

	Fig.		Fig.
<i>Multimeter Type CT.38, front view showing main controls</i>	1	<i>Measurement of current in high-voltage circuits</i>	4
<i>The correct method of using the high-voltage multiplier</i> ...	2	<i>Method of use of RF measuring head unit at very high radio frequencies</i>	5
<i>Alternative method of measuring high voltages in very high resistance circuits...</i>	3	<i>Shunt resistor, diagrammatic view</i>	6

Introduction

1. This Chapter contains information on the correct installation, setting-up and use of the multimeter Type CT38 but it should be noted that it is only possible to describe the use of the instrument in its more routine applications. The design of the instrument is such that a very wide diversity of measurements may be carried out, and the full usefulness of the multimeter will not be realized unless the operator is conversant with its general details and principles of operation; for this reason these matters have been dealt with at some length in Chapter 2.

Controls (fig. 1)

2. All the controls which are required for the normal operating of the instrument are brought

out to the panel face. The details of these controls are as follows :—

- (1) SET FOR MAINS. The mains transformer tappings which permit the transformer to be adjusted to the AC mains supply.
- (2) Three-pin plug for connection to the AC mains.
- (3) OFF/ON. Mains OFF/ON switch. This switch must always be in the OFF position when the instrument is not in use, irrespective of whether the mains supplies are connected or not. This is because the OFF position incorporates a short-circuit of the meter movement, thus damping the movement and protecting it from mechanical damage during transit.

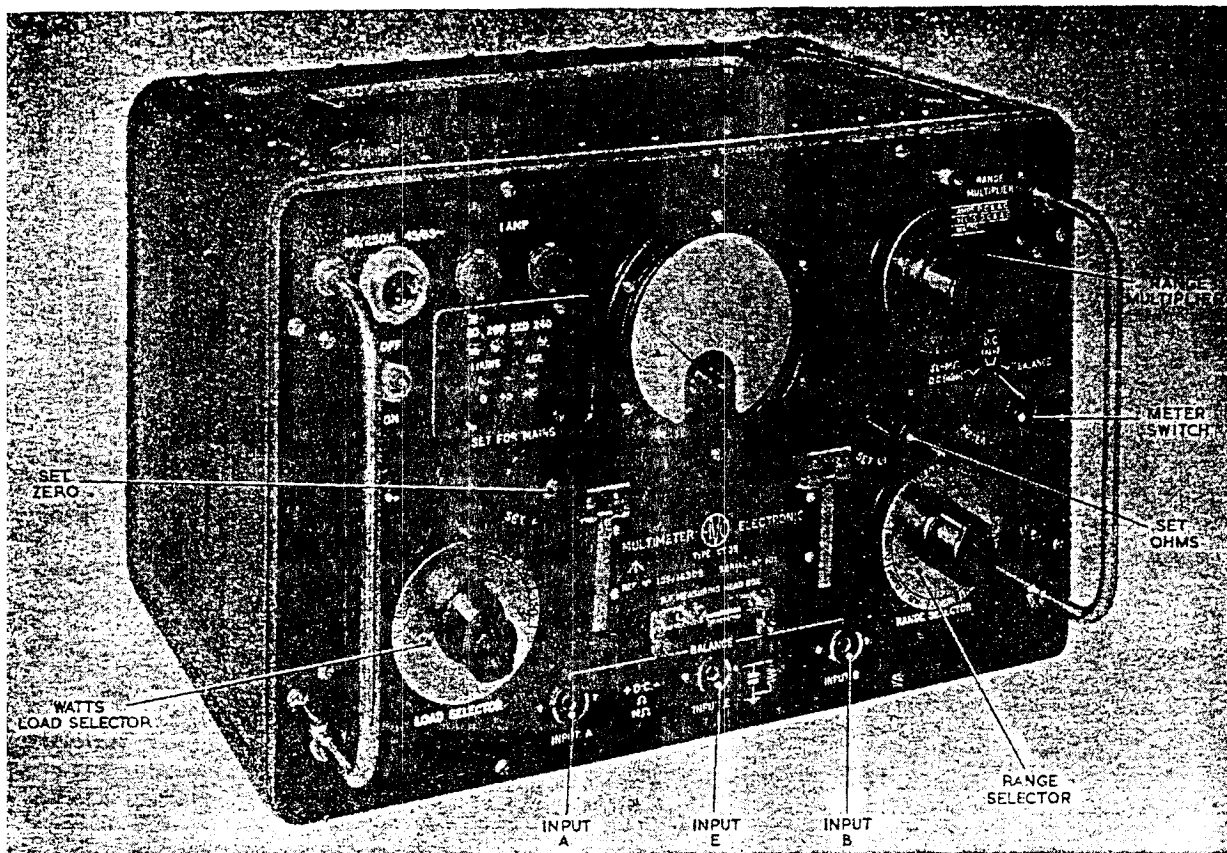

Fig. 1. Multimeter Type CT 38, front view showing main controls

- (4) Fuses. Both the fuses are in the mains supply circuit and spare fuses are located in the accessories container.
- (5) SET ZERO. This control enables the electrical zero to be adjusted prior to making measurements on DC ranges.
- (6) LOAD SELECTOR. A rotary switch which enables the appropriate load to be selected for the measurement of watts.
- (7) RF MEASURING HEAD. This is used for all AC and watts measurement and is supplied with an extension connector for external measurements. This connector is to be found in the accessories container.
- (8) RANGE SELECTOR. This is a rotary switch which enables the required service to be selected.
- (9) SET OHMS. This is a potentiometer across the 12-volt supply from the mains transformer to permit the instrument zero to be set for ohms measurements.
- (10) METER SWITCH. This is a three position switch which enables the connections to the meter to be changed, prior to making reversed polarity measurements. The BALANCE position enables balanced DC voltages to be measured.
- (11) RANGE MULTIPLIER. This rotary switch enables the required multiple of the RANGE SELECTOR setting to be selected.
- (12) INPUT A. The socket used for connection to the high potential point of the circuit to be measured.
- (13) INPUT E. The socket used for connection to the low potential point of the circuit to be measured.
- (14) INPUT B. The socket used for the second high potential point when balanced measurements are being made.
- (15) Pilot lamp. Indicates when power is being supplied to the multimeter.

Preset controls

3. The following controls are preset and are to be found at the rear of the instrument when the dust cover has been removed :—

- (1) VR5. This is the amplifier sensitivity control which should not be disturbed, except by qualified personnel using the AVO Electronic Multimeter Test Unit
- (2) VR4. This control is to enable the zero off set on AC measurements to be correctly set to 0.07V. This adjustment must be effected with the instrument set up on the 1V AC range. Access to this control is obtained by removing the captive plug which is at the bottom of the side of the case adjacent to the input sockets.

- (3) VR3. This is the DC sensitivity control used for calibration purposes to set the initial millivolt drop of the measuring instrument and it should not be disturbed except by qualified personnel using the AVO Electronic Multimeter Test Unit
- (4) VR2. This is the DC zero control and is used to set the measuring instrument zero when it is outside the range of the SET ZERO control on the panel.

4. This chapter includes some of the precautions that are necessary to operate the instrument

correctly and to avoid false readings and results. The reasons why these precautions are necessary are given in some detail so that the operator may have a fuller understanding of the behaviour of the instrument under certain conditions.

Accessories

5. The lid of the multimeter, which is secured over the panel by means of four captive screws, contains a rubber tray which serves as stowage for the loose accessories and spares. Details of these items are as follows :—

<i>Stores Ref.</i>	<i>Nomenclature</i>	<i>Quantity</i>	<i>Remarks</i>
20811-A	Connectors Type 3661	1	RF head connector
20815-A	Connectors Type 3662	1	Instrument to multiplier resistor unit Type 414
20815-D	Connectors Type 3663	1	High voltages INPUT A
20815-B	Connectors Type 3664	2	INPUT A or B connector
20815-C	Connectors Type 3665	1	INPUT E connector
14046-2	Contacts Type 257	1	2 in. pointed metal prod
10969-3	Contacts Type 258	1	Circular prod for RF head
20815-E	Leads Type 197	1	Earthing lead
20759	Resistor units Type 413	1	Shunt resistor unit
20756-A	Resistor units Type 414	1	Multiplier resistor unit
14011	Connectors Type 3429	1	Mains connector
12241-9(SEL)	Valves CV.491	1	Specially aged for inter-changing valve V4
12239-5	Fuses link 1A	2	
50010-4	Lamps filament 6V 1.8W	1	

Preparing for use

6. The lid of the multimeter should be unscrewed and it may be fixed on to the back of the instrument, where four tapped holes are provided for the four captive screws. The lid thus acts as a base for the multimeter when the instrument is being used with the panel horizontal.

7. The connector lead Type 3429 is provided for the mains supply input. This lead is not terminated in a mains plug, and in fitting such a plug it is important that correct mains polarity is observed, the three-core connector lead being connected, red to the live side of the mains supply, blue to the neutral side and green to earth. (It is important that the earth lead (green) is connected to earth both for safety reasons and for the reduction of "pick-up" when the instrument is in an AC field). Before connecting the instrument to the mains supply, the tapping of the mains transformer in the CT38 must be adjusted to the correct point for the mains voltage being used. This is accomplished by removing the perspex cover of the SET FOR MAINS panel, on the front of the instrument, after which, set the screw-plugs to the appropriate position. It is important that the perspex cover is fitted into its position after the adjustment has been completed.

8. The mains lead may now be connected to the mains supply, but before switching on, the mechanical zero of the instrument should be checked and if necessary adjusted. The mechanical zero should seldom require adjustment and, therefore, the screwdriver control should only be operated when necessary. The following sequence should then be followed :—

- (1) Connect the test leads to INPUT A and INPUT E and short-circuit them.
- (2) Switch the RANGE SELECTOR switch to DC AMPS with the MULTIPLIER SWITCH on any amps range.
- (3) Switch the mains ON/OFF switch to the ON position, when the indicator lamp will light.
- (4) Allow the instrument to stand for a period of five minutes. On first switching on, no deflection will be seen on the meter, but after a period of 1½ minutes the thermal delay switch will operate and the instrument will give a sharp random flicker, finally coming to rest in a position near the meter scale zero.
- (5) Adjust the meter needle to zero on the scale with the SET ZERO knob.

9. The zero position of the meter needle may drift slightly during the first few minutes of operation, but the instrument should reach thermal stability in approximately 5 to 10 minutes. After this period the zero drift should only be of the order of one division over a long operating period, but as an additional safeguard it is advisable to make an occasional check of the zero-setting during the first 30 minutes of operation.

10. Care must be taken to check the setting of the mechanical movement zero if the working position of the instrument is changed, for example, if readings are taken with the front panel in a vertical position after being used with it in a horizontal position. Otherwise the error will be corrected by the electrical zero, and will show as a double zero error on the scale, if on any measuring range, reverse polarity measurements are required, and the METER SWITCH is operated to the DC (REV) position. A good check of the correctness of the mechanical zero setting is to note that there is no change in the electrically set zero position in either NORMAL or REV positions of the METER SWITCH.

11. When the short-circuit of the measuring leads is removed no shift in the needle zero should occur with the RANGE SELECTOR set to DC volts, except on the 250-millivolt range where there may be a shift of less than one division. This can be caused by slight grid current in the millivoltmeter valve, and may be corrected by the electrical SET ZERO control so long as the source of the voltage about to be measured has a resistance of not less than 10 megohms, the input resistance of the multimeter. Any source resistance appreciably lower than this value will virtually short-circuit the instrument input resistance and tend to remove

any such grid current error. With a normal instrument, this error may be approximately one per cent.

12. When switching to AC ranges deliberate zero off sets of 0.07V are introduced. However, instances of instability of contact potential of the diode valve V1 may occasionally occur which will be recognized by a shift of the 0.07V off set potential. If this shift is not corrected, errors could appear in the readings obtained on the lower AC ranges, particularly between 0 and 2.5V and between 10 μ A and 2.5A. In addition the watts ranges could be similarly affected. The procedure for correcting this shift of the 0.07V off set is as follows:—

- (1) Set the DC zero.
- (2) Set up the instrument on the 1V AC range with the RF measuring head internal.
- (3) Obtain access to the pre-set control RV4 by removing the captive plug, situated on the side of the instrument adjacent to the INPUT socket.
- (4) Connect a shorting link between the INPUT A and INPUT E sockets.
- (5) Adjust RV4 until the off set reading is corrected to 0.07V.
- (6) After completing the adjustment firmly screw the captive plug back into position and remove the shorting link between the INPUT A and E sockets.

13. Table 1 gives the positions to which the various controls must be set to measure any given range of voltage, current, resistance or power. It should be emphasised once again that this table does not cover all the applications of the multimeter, but only those most commonly used.

TABLE I
Position of controls for given measurements

Measurement to be made	Meter Switch	Range Selector	Range Multiplier	Load Selector	Connect Input to Terminals	RF Measuring Head Unit Position
DC VOLTS						
250 mV to 250V (Negative low potential)	DC Norm.	DC Volts	250 mV to 250 V	—	A and E	—
DC VOLTS						
250 mV to 250V (Positive low potential)	DC Rev.	DC Volts	250 mV to 250 V	—	A and E	—
DC VOLTS						
250V to 1,000V } 1,000V to 2,500V } 2,500V to 10,000V } (Negative low potential)	DC Norm.	DC Amps.	10 μ A 25 μ A 100 μ A	—	Via Multiplier to A and E	—

TABLE I—continued

Measurement to be made	Meter Switch	Range Selector	Range Multiplier	Load Selector	Connect input to Terminals	RP Measuring Head Unit Position
DC VOLTS						
250 V to 1,000V	DC Rev.	DC Amps.	10 μ A	—	Via Multiplier to A and E	—
1,000V to 2,500			25 μ A			
2,500V to 10,000V (Positive low potential)			100 μ A			
DC AMPS						
10 μ A to 1A (Negative low potential)	DC Norm.	DC Amps.	10 μ A - 1A	—	A and E	—
DC AMPS.						
10 μ A to 1A (Positive low potential)	DC Rev.	DC Amps.	10 μ A - 1A	—	A and E	—
DC AMPS.						
1A to 2.5A	DC Norm.	DC Volts	250 mV	—	A and E with shunt	—
2.5A to 10A						
10A to 25A (Negative low potential)						
DC AMPS.						
1A to 2.5A	DC Rev.	DC Volts	250 mV	—	A and E with shunt	—
2.5A to 10A						
10A to 25A (Positive low potential)						
DC VOLTS (BALANCED)						
250 mV - 0 - 250 mV to 100V - 0 - 100V	Balance	DC Volts	250 mV to 100 V	—	A, E and B	—
AC VOLTS						
1V to 250V.. (LF)	~	AC Volts	1V to 250V	—	A and E	Int.
AC VOLTS						
1V to 250V.. (RF)	~	AC Volts	1V to 250V	—	C (RF meas. head) and E	Ext.

TABLE I—continued

Measurement to be made	Meter Switch	Range Selector	Range Multiplier	Load Selector	Connect Input to Terminals	RP Measuring Head Unit Position
1V to 250V AF with probe ext. 	~	AC Volts	1V to 250 V	—	(Series condenser meas. head) and terminal E	Ext.
AC VOLTS 250V to 1,000V 1,000V to 2,500V 2,500V to 10,000V	~	AC Amps.	$\left\{ \begin{array}{l} 10 \mu A \\ 25 \mu A \\ 100 \mu A \end{array} \right.$	—	Via Multiplier to A and E	Int.
AC VOLTS 0 to 250 mV 	~	250 mV AC	—	—	A and E	Int.
AC VOLTS 0 to 100 mV 	~	100 mV AC	—	—	A and E	Int.
AC AMPS. 10 μA to 1A 	~	AC Amps.	10 μA to 1A	—	A and E	Int.
AC AMPS. 1A to 2.5A 2.5A to 10A 10A to 25A	~	250 mV AC	—	—	A, E with shunt	Int.
WATTS 50 μW to 5W 	~	Watts	50 μW - 5W	15 Ω to 5000 Ω	A and E	Int.
OHMS 2 Ω to 200 Ω	Ω - M Ω	$\Omega \times 1$	—	—	A and E	—
OHMS 20 Ω to 20k Ω	Ω - M Ω	$\Omega \times 100$	—	—	A and E	—
OHMS 2K Ω to 2M Ω	Ω - M Ω	$\Omega \times 10^4$	—	—	A and E	—
MEGOHMS 1 M Ω to 1,000M Ω	Ω - M Ω	M Ω	—	—	A and E	—

Precautions to be observed during use

14. Due to the sensitivity and general design of the multimeter Type CT38, certain precautions should be observed during use in order that false or misleading results are not obtained from the instrument. Further precautions must be taken when using the multimeter to measure high voltages or currents in high-voltage circuits. In the succeeding paragraphs the most important of these precautions are given and the user of the equipment should keep them in mind when using the instrument.

DC volt ranges

15. Before setting up the instrument on any DC range, it is necessary to determine the polarity of the voltage which is to be measured, with respect to the low potential line of the CT38. The METER SWITCH should be set to the appropriate position as given in Table 1.

16. On the ranges 1 volt, 10 volts, and 100 volts the meter needle position should be read on the 0 to 100 black scale; the 250 mV, 2.5V, 25V, 250V ranges are read on the 0 to 25 black scale. The initial reading on the 250 mV is one scale division, which corresponds to 5 mV.

17. The input resistance of the multimeter on these DC ranges remains constant at $10\text{ m}\Omega$; therefore the sensitivity will be $40\text{ m}\Omega/\text{volt}$ at 250 mV, $40,000\ \Omega/\text{volt}$ at 250V with corresponding sensitivities at voltages between these limits.

18. Where there is a possibility of there being a considerable AC voltage at the point of DC measurement, as at the anode of an AF or RF amplifier valve, this may be prevented from affecting the measurement by inserting a stopper resistance in the high potential measuring lead at the point of measurement. This stopper resistance may be an ordinary $\frac{1}{2}$ watt type of either 0.05 or $0.1\ \text{m}\Omega$, and assuming the last value to be used, the error in measurement due to this added resistance will only be $0.1\ \text{m}\Omega/10\ \text{m}\Omega$ or 1 per cent. This will be considerably less than the error due to the presence of an AC voltage. This arrangement has the further advantage of reducing the effect of the input capacitance of the instrument and its leads on the circuit being measured, which may result in attenuation of output or detuning of the circuit under test. In cases such as these, where the AC impedance of the DC voltage ranges can be of importance, it is advisable to refer to the DC VOLTS circuit diagram (*fig. 10 and fig. 18 of Chap. 2*) in relation

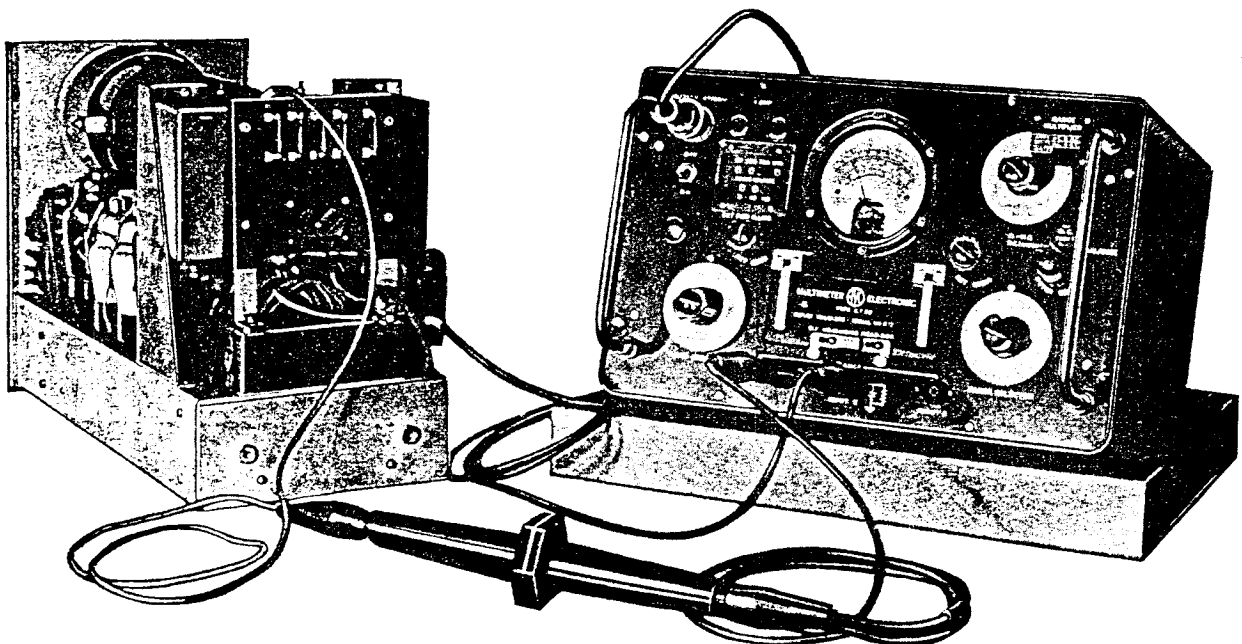

Fig. 2. The correct method of using the high-voltage multiplier

to the DC volts range in use so that the probable effect of the internal by-pass condensers and the distributed capacitance of the instrument on the AC circuit under test can be estimated. The effect is likely to be most marked on the 250 mV DC range where the $0.1 \mu\text{F}$ by-pass condenser C4 is virtually directly across the DC measuring terminals.

DC high-voltage ranges

19. On the ranges from 250 volts up to 10,000 volts, the $100 \text{ m}\Omega$ voltage multiplier is used with the high-voltage leads, the multiplier being connected in the high-potential lead. When using the multiplier the multimeter must be switched to the appropriate DC current range as given in Table 1.

20. When working upon high voltage circuits, the Multimeter should be set to the correct range, and the multiplier connected to the instrument by means of its special leads. Care should be taken to ensure that the Multiplier is isolated from "earth" and all metallic objects and connections made to the apparatus under test, which should be completely dead at this juncture. The hands and all parts of the body must then be removed from the vicinity of the whole apparatus, before the high voltage circuit is energised. It may prove dangerous to touch any part of the apparatus under test, the multiplier, its leads or the Multimeter when the high voltage circuit is energised.

Note . . .

On the DC ranges from 0 to 250V the input resistance may be increased from 10 megohms to 110 megohms by inserting the multiplier resistor unit of 100 megohms between the socket INPUT A and the source to be measured, under which circumstances the readings obtained must be multiplied by 11.

High DC voltages and the use of the meter switch

21. As a safety precaution the case of the multimeter is earthed and the low potential line INPUT E of the measuring circuit is connected to earth via a condenser C13 and a leak resistor R98 (fig. 18 and 19 of Chap. 2). The low potential terminal therefore may assume either negative or positive polarity with respect to earth, depending upon the circuit under test, and the METER SWITCH provides reversal of the meter movement to give correct deflection of the meter.

22. When measuring high voltages, the low potential terminal of the instrument should always be connected to the earthy end of the circuit under test. Before making measurement at high voltages, the polarity of the source be-

ing measured should be checked, and the instrument connected so that the low potential terminal is connected to the low potential side of this circuit, and the METER SWITCH set to give the correct direction of meter deflection. In this multimeter the voltage existing between the low potential line and earth should never exceed 800 volts, or there is a danger of condenser C13 breaking down.

23. In very high resistance circuits, apart from the safety considerations already discussed, it is possible that even the very high input resistance of the CT38 would alter the voltage distribution of the circuit due to its shunting effect. In such cases it is often possible to obtain more accurate voltage readings by indirect measurements. In the example shown in fig. 3, assuming that it is desired to measure the voltage across R1, more accurate results will be obtained if first the source volts are measured, and then the voltage across R2; the difference being taken as the voltage across R1. The effect of the input resistance of the CT38 is very considerably increased by taking a direct reading across the high resistance R1.

24. Similar precautions to those given in para. 20 must be observed when measuring currents in high-voltage circuits. The instrument must be connected in series in the circuit under test so that INPUT E, the low potential terminal, is always connected to the point of low potential or the earthy side of the circuit. The illustrations (a) and (b) of fig. 4 show incorrect and correct methods of connecting the instrument; it is obvious from (a) of fig. 4 that this method of connection will result in the full high voltage of the circuit being developed across the network C13, R98 in the multimeter and would almost certainly cause a breakdown of C13.

25. A practical example of the use of the multimeter to measure the anode current of a valve

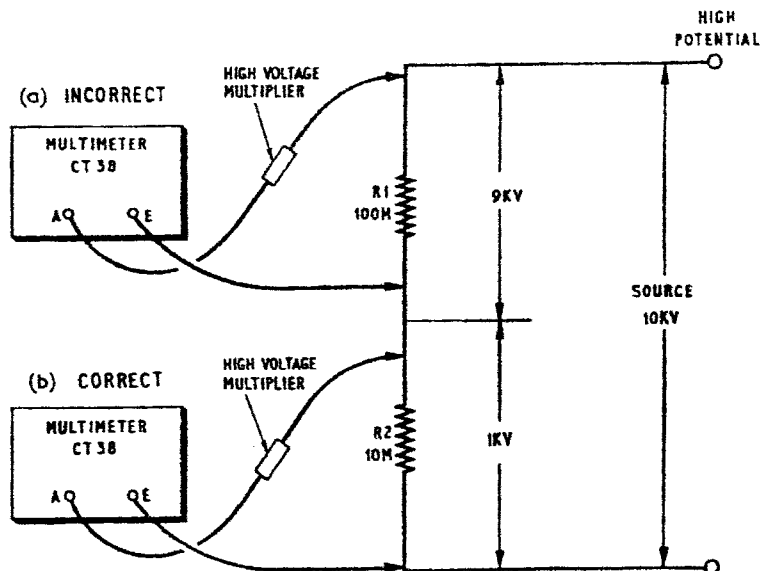

Fig. 3. Alternative method of measuring high voltages in very high resistance circuits

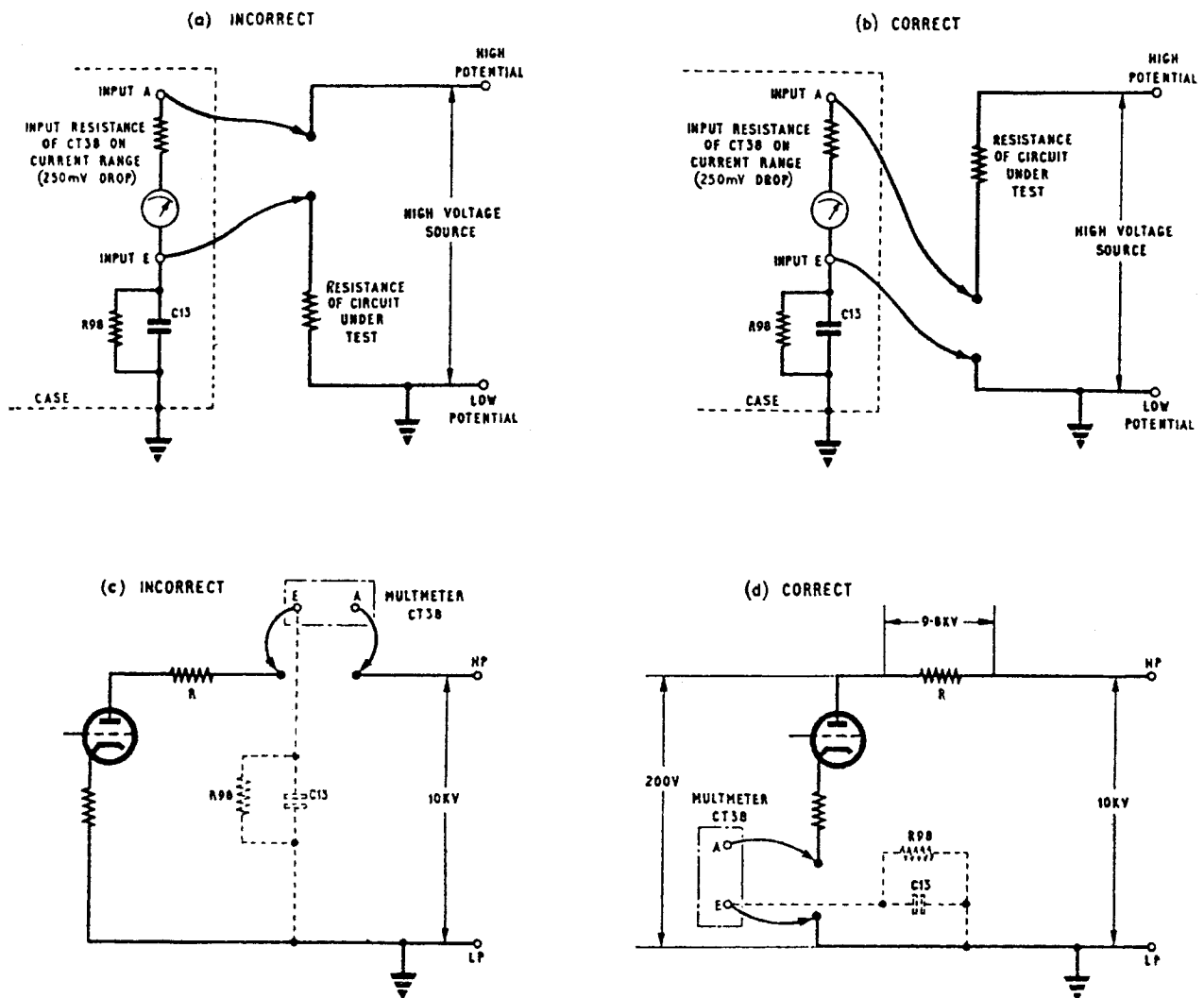

Fig. 4. Measurement of current in high-voltage circuits

working in a high voltage circuit is given in (c) and (d) of fig. 4. The meter should not be connected as shown in (c) of fig. 4 for the reasons already given, the correct measuring position of the CT38 being in the low-potential cathode circuit of the valve ((d) of fig. 4). If for some reason it is impossible to make the connection in the cathode circuit, then the point of next lowest potential should be used, and in this example the instrument should be connected between the anode of the valve and resistor R, where the voltage is some 200 volts above earth potential.

AC volts ranges (The precautions set out in para. 20 should be carefully observed.)

26. The precise method of AC volts measurement chosen will very largely depend upon the circuit conditions in which the voltage to be measured occurs, and the frequency of this voltage.

Note . . .

When using the instrument for AC measurements the high-potential test lead should always be connected to the high-potential side of the voltage source being measured, with respect to earth. Failure to do this

means that the 0.01 μ F condenser, which is connected between the low-potential terminal of the instruments and its case (C13 of Fig. 19 of Chapter 2) is now connected across the voltage source being measured. Since under correct measuring conditions the input capacitance of the instrument is some 30 pF, wrong connection of the leads may cause considerable inaccuracy.

27. For normal power frequency and audio frequency measurements where the input capacitance of the multimeter is not likely to cause errors, the instrument may be used with the RF measuring head housed internally and using the normal measuring leads.

28. Where sinusoidal voltages only are likely to be encountered, the RMS calibration of the voltage scales can be accepted. It must be realized, however, that where the voltage or voltages are likely to be other than sinusoidal, the most useful interpretation of readings will be given by a measurement of the peak value of the voltage obtained by multiplying the RMS meter scale

readings by a figure of 1·41. Unless such a method is used, erroneous meter readings may be observed even at power and audio frequencies. For example, considerable inaccuracy may occur in measurements on constant voltage power supplies using saturated iron cored components, vibrator supplies, or circuits using continuously variable transformers particularly when these are used at the low voltage end of the auto-transformer winding.

29. Provided that the source impedance of the voltage being measured is low in comparison with the input impedance of the multimeter (which at 50 c/s may be taken as $2 M\Omega$) and that the instrument input capacitance of some 30 pF does not affect the circuit conditions, then the voltage ranges with the measuring head used internally can be assumed correct up to frequencies of approximately 1 Mc/s. In general, however, it is advisable to use the instrument with the measuring head external when measuring voltages at frequencies above the audio frequency range.

30. In cases where the source impedance is high and/or where the input capacity of 30 pF in conjunction with the source impedance is likely to have a large enough time constant to affect the accuracy of readings, it is advisable to use the measuring head external even at power and audio frequencies. At low frequencies the series impedance of the small-value internal coupling condenser in the measuring head (C2 of *fig. 19 of Chap. 2*) is sufficiently high to give an appreciable frequency error and in such circumstances the high-potential input to the measuring head should not be made directly to terminal C, but to terminal

D via a condenser of suitable capacitance. A condenser of $0\cdot1 \mu F$ will cause an error of only 1 to 2 per cent at 50 c/s, whilst for frequencies down to say 10 c/s the value of this series condenser should be increased to between $0\cdot5$ and $1 \mu F$.

31. It should be noted that errors may be obtained due to an apparently low effective input impedance of the instrument with circuits of very high source impedance when this impedance is comparable with the input impedance of the diode measuring circuit in the measuring head unit. It will be realized that in such cases the charge and discharge time constants of the diode input circuit are similar, and therefore the peak value of the voltage being measured is not attained.

32. When using the measuring head in conjunction with a condenser connected to terminal D, the working voltage of the condenser must be such as to withstand the normal range of AC voltages (0·1 volt to 250 volts) together with the peak DC voltage occurring at the diode anode and any superimposed DC voltage which may exist at the voltage source being measured. If a voltage measurement is being made with the measuring head internal, a superimposed DC voltage of some 500 volts may be accommodated, but should the DC voltage exceed this, the head should be used externally with a series condenser to terminal D, the working voltage of this condenser being great enough to withstand the highest DC voltage expected.

33. Using the measuring head externally and terminal C for measurements (that is, when measuring voltages at frequencies above low

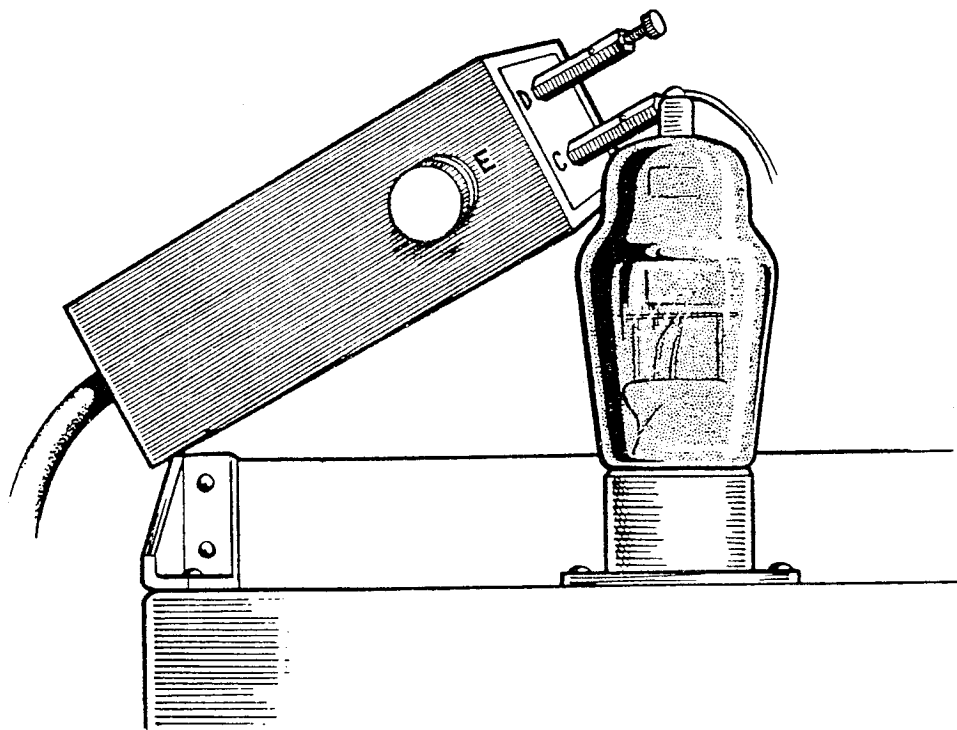

Fig. 5. Method of use of RF measuring head unit at very high radio frequencies

audio frequencies) DC voltages in the circuit being measured should not exceed a value of approximately 100 volts.

34. For measurements at radio frequencies the measuring head should always be used externally and input connections will be made to the terminals C (high potential) and E (earthy) on the head unit. A special prod (Type 258) is provided with the accessories for connection to terminal C when required. Although the precise conditions may vary from instrument to instrument, the special construction of the measuring head unit is such that its natural resonance point (the resonance curve being very broad and flat) occurs in general at frequencies exceeding 350 Mc/s. Measurements may thus be made with reasonable accuracy at frequencies up to some 250 Mc/s, but it must be stressed that the performance at radio frequencies, particularly at frequencies above 50 Mc/s, will depend very largely on the way in which connections are made between the circuit under test and the measuring head.

35. The ideal condition for such connections is that they should add no series inductance, parallel capacitance or RF resistance to the measuring circuit. Whilst this is unattainable, in practice the lead to terminal C should be the shortest possible length (in many cases direct contact can be made with terminal C to the measuring point) and of small physical dimensions to keep the additional inductance and capacitance to a minimum.

36. The low resistance earthing of terminal E is most important. The lead to this terminal should be short, to avoid errors due to standing waves, and it should also be of such physical dimensions that it forms an earth return of negligible RF resistance (for example, a short length of copper tape or braid). A more desirable method, particularly at high radio frequencies, is to directly clamp terminal E to a point on the earthy chassis of the equipment being tested as near as possible to the chassis earth point. Alternatively, the measuring head case may be held firmly against the chassis (fig. 5).

Note . . .

A metal braid earthing lead (Type 197) is supplied with the instrument for general use, which is of reasonably small dimensions and low resistance construction, but frequency and circuit considerations alone will determine whether this lead may be used or some special arrangement is necessary.

AC millivolts (250 mV range)

37. This range uses the decade amplifier of the instrument (fig. 15 of Chap. 2) in conjunction with the normal 2.5 volt AC range and consequently the frequency characteristic of the range is virtually that of the amplifier stage. Although only originally designed to cover audio frequency measurements this range has a linear frequency characteristic, within about 1 or 2 per cent, to

about 250 kc/s and thereafter falls steadily until at 1 Mc/s its response is approximately 40 per cent down on its 50 c/s value.

38. The zero offset will be seen to be about 4 per cent of FSD, representing a figure of 10 mV and is thus about 1 per cent higher than the offset on the 2.5 volt range. This extra figure of offset is caused by a small amount of mains voltage, usually about 2 mV, which occurs across the low potential coupling condenser C6 (fig. 15 of Chap. 2) due to the inter-winding capacities of the mains transformer; as has already been explained in Chapter 2, quite elaborate screening has been introduced in the mains transformer to keep this effect at a minimum.

39. The degree of offset may vary very slightly when making measurements in different locations, dependent on whether an appreciable voltage exists between the neutral mains line and earth on the power supply being used. This small zero variation should not be sufficient to influence readings, and it can be neglected in relation to the accuracy of measurements on this range, which can be considered as conforming to the linear scale of the meter above 25 mV or 10 per cent of FSD.

40. Here again the range is calibrated in RMS values assuming a sinusoidal input waveform and similar remarks to those on the ordinary AC ranges apply regarding inputs having distorted waveforms. It will be noted that since this range uses the normal measuring sockets on the front of the instrument leading to the input of the decade amplifier stage housed internally, the fairly high value of input capacitance (60 pF) in parallel with a resistive value of 0.75 m Ω must be taken into consideration when making measurements at high frequencies from a voltage of high source impedance. Care will also have to be taken in these circumstances in regard to the capacity and inductance of the measuring leads.

AC millivolts (100 mV range)

41. This range is not called for as one of the specified ranges of the instrument and therefore no attempt has been made to provide great accuracy. The full scale accuracy can be taken as better than 10 per cent, however, and the offset will be similar to the 250 mV range i.e. 10 mV or 10 per cent FSD. Similar remarks in relation to frequency characteristics, the injection of spurious voltages due to imperfect mains earthing will apply, as also will the comments relative to input capacitance and resistance, and the inductance and capacitance of measuring leads.

42. The range is useful for the indication of low AC voltages in numerous applications such as the null indications in AC bridge circuits.

AC current ranges

43. These ranges use the 250 mV AC range (fig. 16 of Chapter 2) and therefore are subject to similar zero offset and scale linearity limitations

as have been given in preceding paragraphs. The frequency range is basically that of the 250 mV range, modified at very low current values by the effect of the time constant of the resistive value of the shunt ($25\text{ k}\Omega$ in the case of the $10\ \mu\text{A}$ range) in parallel with the input capacitance of the decade amplifier (60 pF) together with any lead capacitance which may be introduced. This effect is increased to some extent by a small amount of inductance in the shunt and connecting leads. In general it will be found that for currents above 1 mA , provided that care is taken with the connecting leads, the ranges are accurate to better than $\pm 5\text{ per cent}$ up to 250 kc/s .

AC and DC current measurements 1A to 25A (fig. 6)

44. These measurements are made by using the tapped shunt resistor (fig. 6) and special connector leads provided in the accessories container. The

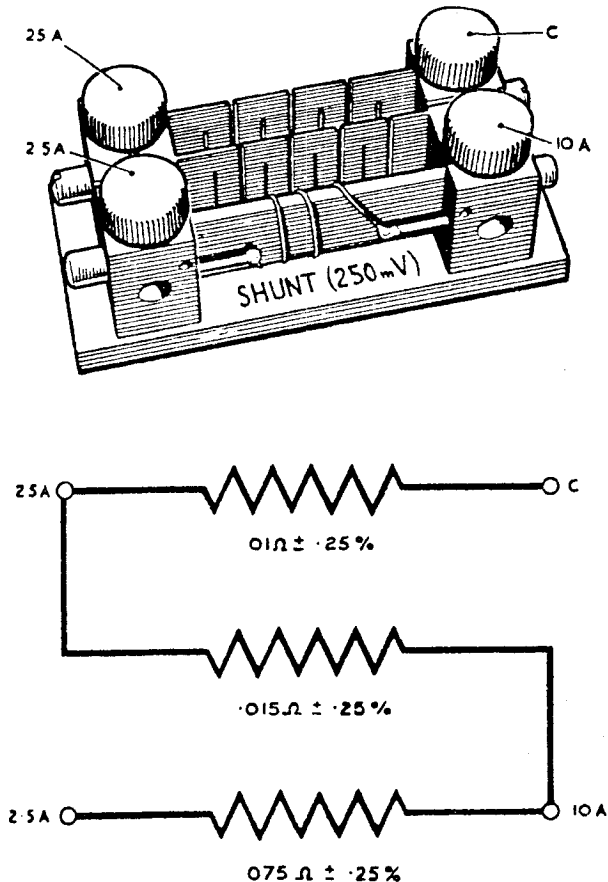

Fig. 6. Shunt resistor, diagrammatic view

RANGE SELECTOR switch of the CT38 should be turned to the appropriate 250 millivolt position (Table 1) and the connector leads plugged into the INPUTS A and E, after which proceed as follows:—

- (1) 1 to 2.5 A. Connect the external circuit to terminals C and 2.5 A of the shunt and the clips of the connectors, corresponding to A and E, to the brass terminals C and 2.5 A respectively.
- (2) 2.5 to 10 A. Connect the external circuit to terminals C and 10 A of the shunt and the clips of the connectors, corresponding to A and E, to the brass terminals C and 10 A respectively.
- (3) 10 to 25 A. Connect the external circuit to terminals C and 25 A of the shunt and the clips of the connectors, corresponding to A and E, to the brass terminals C and 25A respectively.

Watts measuring ranges

45. These ranges use a basic voltage sensitivity of 173 mV given by the decade amplifier feeding a 1.73 volt tapping point on the AC volts resistor chain (fig. 17 of Chapter 2). The multiplication on these ranges is given by the interposition of a six-position attenuator between the voltage tapping on the lead resistance and the amplifier input. The zero offset will still represent 10 mV or 6 per cent FSD, and thus occurs well below the first watts scale marking of .05, at which point the instrument will be within the accuracy quoted.

46. No appreciable error will be encountered to well above the audio frequency range, but the extension of range into the low radio frequencies will obviously be modified by the effect of distributed capacitance on the load resistance potential divider, and by the amplifier input capacitance on the range multiplying attenuator.

Ohms and megohms ranges

47. No particular comments are necessary on these ranges with the exception that when measuring low resistances the resistance of the connecting leads will obviously have to be taken into account. Similarly, when measuring high resistances in the order of megohms the hands will naturally not be allowed to come into contact with the measurement points, and the resistance being measured should not be lying on a bench or other surface whose surface contact resistance is likely to be comparable with the resistance under measurement.

